

PEARL HI-HAT STAND

H-1050

Instruction Manual

Congratulations on your purchase!
To get optimum performance of your H-1050 Hi-Hat Stand,
please read this Instruction Manual before playing.

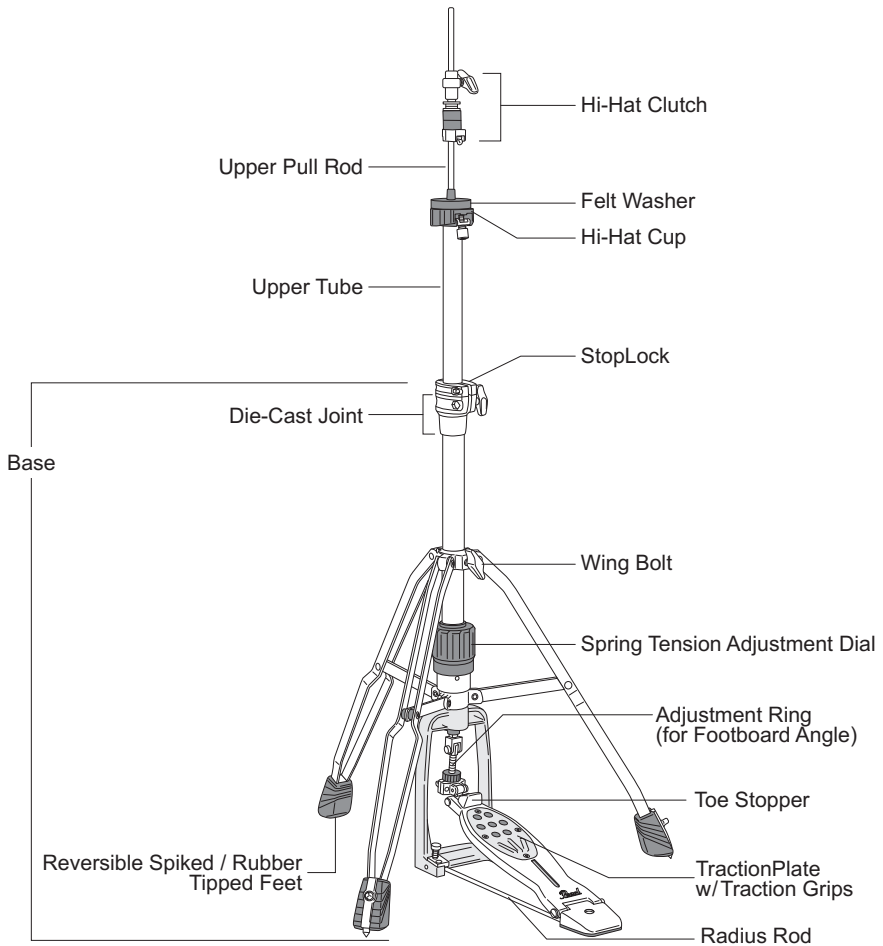

Footboard Attachment

Squeeze the Radius Rods together and insert the ends into the Holes in the Support Casting as shown. Loosen the Wing Bolt and spread the legs. Stand the hi-hat base vertically and set the bottom of the Support Casting squarely on the floor to form a solid tripod. Tighten the Wing Bolt to secure the Base section (Fig.1).

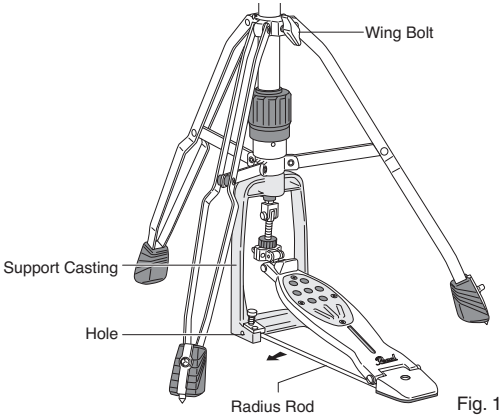

Fig. 1

Swivel Leg Adjustment

The legs can be swiveled to the desired position. To do so, loosen the Wing Bolt and adjust the position of the legs. When set, make sure the tripod is stable and tighten the Wing Bolt (Fig.2).

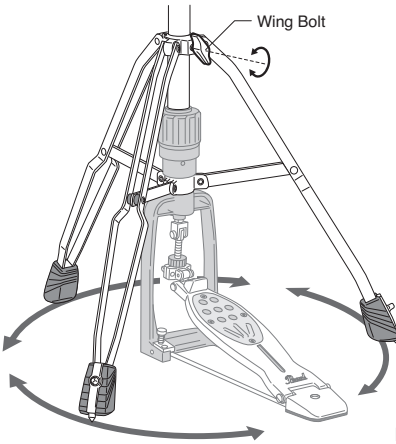

Fig. 2

Tip

Test the stability of the hi-hat before playing. Readjust the legs as necessary to achieve a stable tripod before proceeding.

Upper Section Assembly

Thread the Upper Pull Rod into the Connector inside the Die Cast Joint as shown in (Fig.3-A) and tighten securely. Insert the Upper Tube into the Die Cast Joint and set the height to your preference then tighten the Wing Nut. Set the Stop Lock by loosening the Key Bolt and sliding the Stop Lock against the Die Cast Joint, then retighten the Key Bolt. Thread the Lower Hi-Hat Cymbal through the Upper Pull Rod and place it on the Hi-Hat Cup. Assemble the Top Hi-Hat Cymbal and the Hi-Hat Clutch as shown in (Fig.3-B). Tighten the Key Bolt on the Bottom Nut (Fig.3-C) to prevent it from loosening during performance. Mount the Clutch with the Top Hi-Hat Cymbal attached to the Upper Pull Rod. Adjust the distance between the top and bottom cymbals to your preference then secure the Clutch by tightening the Wing Bolt.

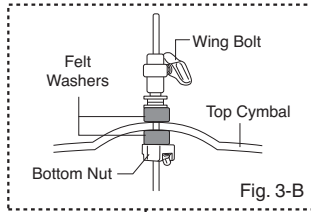

Fig. 3-B

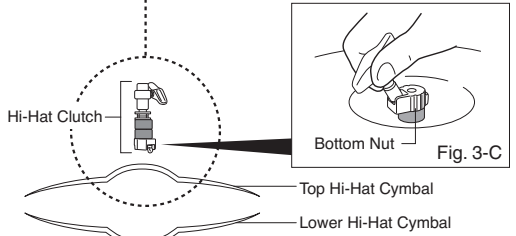

Fig. 3-C

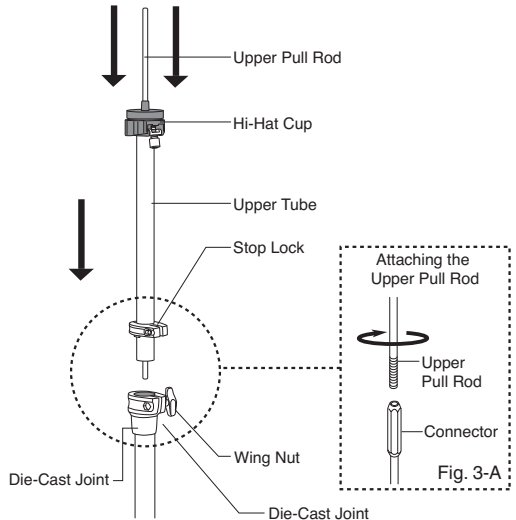

Fig. 3-A

Hi-Hat Cup Tilt Adjustment

Turn the Knurled Knob to tilt the bottom cymbal to help prevent "air lock" between the cymbals (Fig.4).

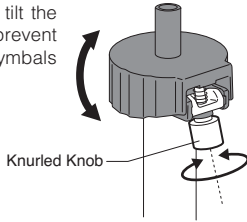

Fig. 4

Spring Tension Adjustment

The spring tension can be adjusted quickly and precisely by turning the Spring Tension Dial. This innovative system features extended tension range and click-stops for slip-proof performance under the most demanding playing conditions (Fig.5).

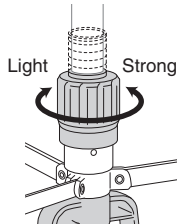

Fig. 5

Footboard Angle Adjustment

To change the footboard angle, loosen the Key Bolt and turn the Adjustment Ring. When the desired angle is achieved, re-tighten the Key Bolt to retain this setting (Fig.6).

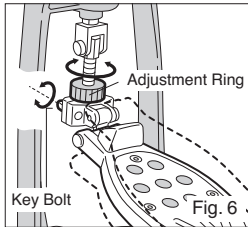

Fig. 6

Tip

When changing the footboard angle, make sure that the Upper and Lower Pivots are parallel as shown in (Fig. 7)

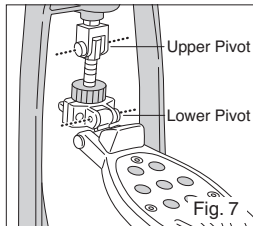

Fig. 7

Traction Grip and Traction Plate Adjustment

The Traction Grip dots can be totally removed or inserted as needed to custom tailor the amount of traction for your personal playing style. To remove the Traction Grip dots, loosen the Allen Screws holding the Traction Plate with the provided hexagonal wrench and remove the Traction Plate from the footboard (Fig.8). The Traction Plate is also reversible to provide just the right amount of grip at either the front or rear of the footboard (Fig.9).

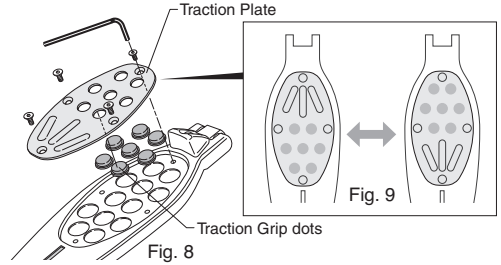

Fig. 8

Fig. 9

CAUTION

When putting the Traction Plate back, finger-tighten the four screws to prevent cross-threading; then tighten the screws securely. Do not use the Pedal without the Traction Plate mounted. It could cause injury to your foot.

Reversible Spiked / Rubber Tipped Feet

For maximum slip prevention, the Spike Tip should be used. Loosen the Key Bolt until the Spike is easily turned then rotate the Spike downward. Tighten the Key Bolt to lock the Spike (Fig.10).

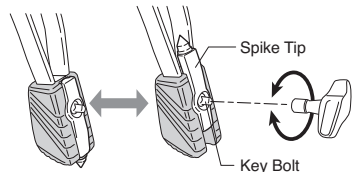

Fig. 10

Tip

The Spikes are sharp and can cause serious personal or property injury. To prevent mishaps, use extreme care when handling the stand especially when the Spike Tips are exposed. A rug or carpet should be used to protect floor surfaces whenever the Spikes are used.

Maintenance

The Base Tube is secured to the Support Casting with an Allen screw. In the event the Base Tube becomes loose, tighten the Allen screw with the provided hexagonal wrench to restore stability.

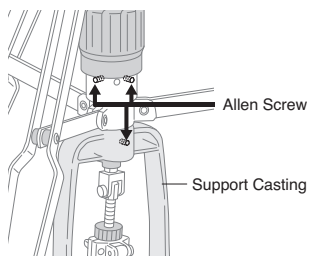

CAUTION

- ◆ Periodically check all Allen Screws for tightness and tighten them with the provided hexagonal wrench as needed.
- ◆ Periodically lightly lube external moving parts such as the Chain, Wing Nuts, Wing Bolts, Key Bolts, and Footboard Hinge to achieve optimum performance from your stand.
- ◆ To maximize traction of the rubber mat beneath the heel plate, keep it clean and dust free using a damp cotton towel.

Pearl

<http://www.pearldrums.com>

Products and specifications are subject to change without notice.

Printed in China