



DSP 204, DSP 206, DSP 306, DSP 408
digital speaker management system



Musikhaus Thomann
Thomann GmbH
Hans-Thomann-Straße 1
96138 Burgebrach
Germany
Telephone: +49 (0) 9546 9223-0
E-mail: info@thomann.de
Internet: www.thomann.de

08.08.2019, ID: 435191, 435192, 435193, 435194

Table of contents

1	General information	4
1.1	Further information.....	4
1.2	Notational conventions.....	4
1.3	Symbols and signal words.....	5
2	Safety instructions	6
3	Features	8
4	Installation and starting up	9
5	Connections and controls	11
6	Operating on the unit	13
7	Control on the computer	19
8	Technical specifications	30
9	Plug and connection assignment	32
10	Protecting the environment	33

1 General information

This user manual contains important information on the safe operation of the device. Read and follow all safety notes and all instructions. Save this manual for future reference. Make sure that it is available to all persons using this device. If you sell the device to another user, be sure that they also receive this manual.

Our products and user manuals are subject to a process of continuous development. We therefore reserve the right to make changes without notice. Please refer to the latest version of the user manual which is ready for download under www.thomann.de.

1.1 Further information

On our website (www.thomann.de) you will find lots of further information and details on the following points:

Download	This manual is also available as PDF file for you to download.
Keyword search	Use the search function in the electronic version to find the topics of interest for you quickly.
Online guides	Our online guides provide detailed information on technical basics and terms.
Personal consultation	For personal consultation please contact our technical hotline.
Service	If you have any problems with the device the customer service will gladly assist you.

1.2 Notational conventions

This manual uses the following notational conventions:

Letterings

The letterings for connectors and controls are marked by square brackets and italics.

Examples: *[VOLUME]* control, *[Mono]* button.

Displays

Texts and values displayed on the device are marked by quotation marks and italics.

Examples: '24ch', 'OFF'.

Text input

Text inputs that are carried out on the device are indicated by typewriter font.

Example: 2323

Instructions

The individual steps of an instruction are numbered consecutively. The result of a step is indented and highlighted by an arrow.

Example:

1. ▶ Switch on the device.
2. ▶ Press *[Auto]*.
 ⇒ Automatic operation is started.
3. ▶ Switch off the device.

1.3 Symbols and signal words

In this section you will find an overview of the meaning of symbols and signal words that are used in this manual.

Signal word	Meaning
DANGER!	This combination of symbol and signal word indicates an immediate dangerous situation that will result in death or serious injury if it is not avoided.
NOTICE!	This combination of symbol and signal word indicates a possible dangerous situation that can result in material and environmental damage if it is not avoided.
Warning signs	Type of danger
	Warning – danger zone.

2 Safety instructions

Intended use

This device is intended to be used for amplification, mixing and playback of signals from musical instruments and microphones. Use the device only as described in this user manual. Any other use or use under other operating conditions is considered to be improper and may result in personal injury or property damage. No liability will be assumed for damages resulting from improper use.

This device may be used only by persons with sufficient physical, sensorial, and intellectual abilities and having corresponding knowledge and experience. Other persons may use this device only if they are supervised or instructed by a person who is responsible for their safety.

Safety



DANGER!

Danger for children

Ensure that plastic bags, packaging, etc. are disposed of properly and are not within reach of babies and young children. Choking hazard!

Ensure that children do not detach any small parts (e.g. knobs or the like) from the unit. They could swallow the pieces and choke!

Never let children unattended use electrical devices.



NOTICE!

Risk of fire

Do not block areas of ventilation. Do not install the device near any direct heat source. Keep the device away from naked flames.



NOTICE!

Operating conditions

This device has been designed for indoor use only. To prevent damage, never expose the device to any liquid or moisture. Avoid direct sunlight, heavy dirt, and strong vibrations.

Only operate the device within the ambient conditions specified in the chapter 'Technical specifications' of this user manual. Avoid heavy temperature fluctuations and do not switch the device on immediately after it was exposed to temperature fluctuations (for example after transport at low outside temperatures).

Dust and dirt inside can damage the unit. When operated in harmful ambient conditions (dust, smoke, nicotine, fog, etc.), the unit should be maintained by qualified service personnel at regular intervals to prevent overheating and other malfunction.



NOTICE!

Possible damage due to installation of a wrong fuse

The use of different types of fuses can cause serious damage to the unit.
Fire hazard!

Only fuses of the same type may be used.

3 Features

- Digital mixer
- Inputs:
 - DSP 204 (item no. 435191): 2 mono channels (XLR chassis sockets) for signals with line level
 - DSP 206 (item no. 435192): 2 mono channels (XLR chassis sockets) for signals with line level
 - DSP 306 (item no. 435193): 3 mono channels (XLR chassis sockets) for signals with line level
 - DSP 408 (item no. 435194): 4 mono channels (XLR chassis sockets) for signals with line level
- Outputs:
 - DSP 204 (item no. 435191): 4 mono channels (XLR chassis plugs) for signals with line level
 - DSP 206 (item no. 435192): 6 mono channels (XLR chassis plugs) for signals with line level
 - DSP 306 (item no. 435193): 6 mono channels (XLR chassis plugs) for signals with line level
 - DSP 408 (item no. 435194): 8 mono channels (XLR chassis plugs) for signals with line level
- Comprehensive setting options for optimal sound:
 - Parametric equalizer
 - Graphic equalizer
 - High- and low-pass filters
 - Noise Gate
 - Limiter
 - Phase inversion
- USB port for computer control using the supplied software
- D-Sub socket for remote control or for the cascading of several devices
- Network connection for integrating the device in a local network
- Operation of the device via buttons, jog wheel and display

4 Installation and starting up

Unpack and check carefully there is no transportation damage before using the unit. Keep the equipment packaging. To fully protect the product against vibration, dust and moisture during transportation or storage use the original packaging or your own packaging material suitable for transport or storage, respectively.

Create all connections while the device is off. Use the shortest possible high-quality cables for all connections. Take care when running the cables to prevent tripping hazards.

Rack mounting

The unit has been designed for rack mounting in a standard 19-inch rack; it occupies one rack unit.

Configuration example 1

The figure schematically shows how the device can be controlled via a computer's USB port.

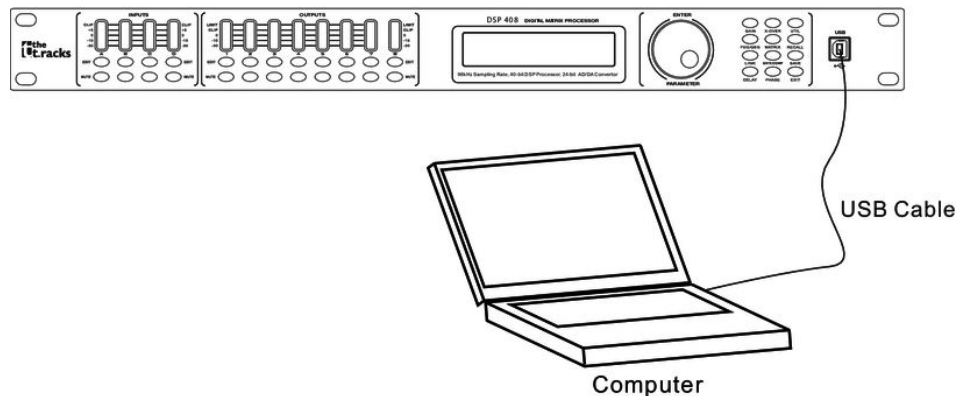

Configuration example 2

The illustrations show schematically how one device or several devices can be integrated into a local area network (LAN).

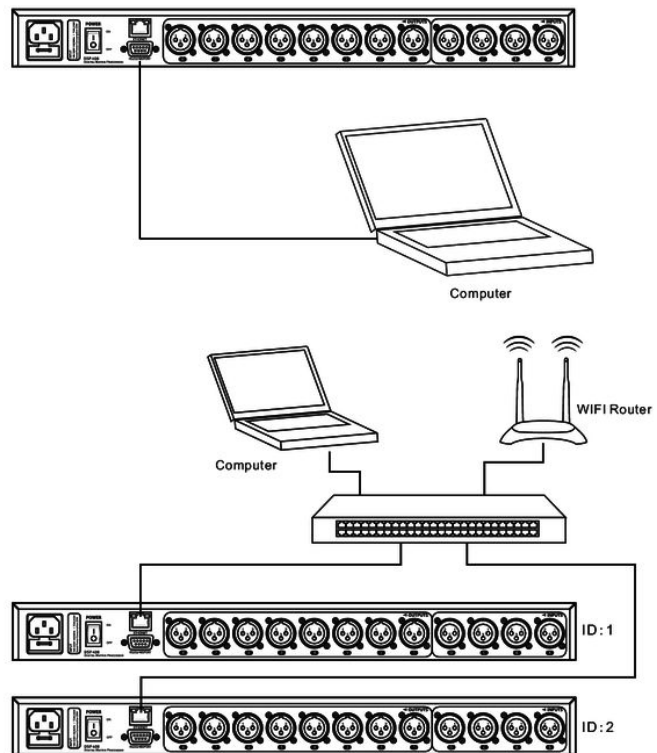

Configuration example 3

The illustrations show schematically how a device can be configured via the serial port.

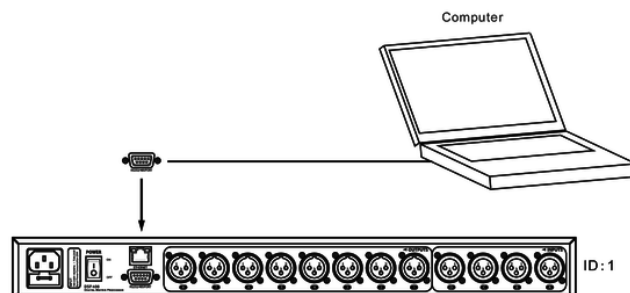

5 Connections and controls

Front panel

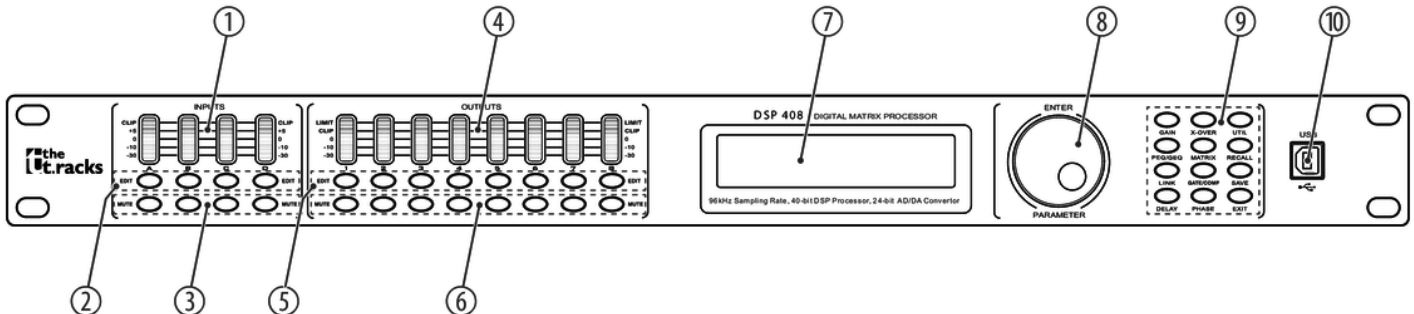

1	[INPUTS] Level indicator for the input channels. The number of channels depends on the device design. The red [CLIP] LEDs indicate overload (clipping). In this case the level of the input signal is too high.
2	[EDIT] Buttons for selecting the edit mode for the respective input channel. The set parameters of the selected channel appear in the display.
3	[MUTE] Buttons for muting or unmuting the respective input channel.
4	[OUTPUTS] Level indicator for the output channels. The number of channels depends on the device design. The red [CLIP] LEDs indicate overload (clipping). In this case the level of the output signal is too high. The red [LIMIT] LEDs indicate that the built-in limiter has been tripped.
5	[EDIT] Buttons for selecting the edit mode for the respective output channel. The set parameters of the selected channel appear in the display.
6	[MUTE] Buttons for muting or unmuting the respective output channel.
7	Display
8	[ENTER / PARAMETER] Jog wheel
9	Buttons for direct selection of a parameter. Use the [EXIT] button to leave the edit mode.
10	[USB] USB port

Rear panel

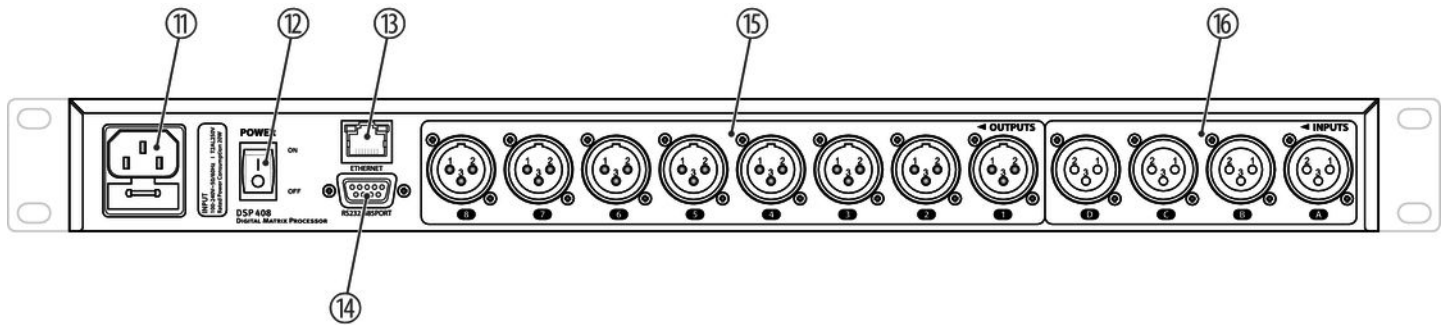

11	Plug for mains cable with fuse holder
12	<i>[POWER]</i> Main switch. Turns the device on and off
13	<i>[ETHERNET]</i> RJ45 socket as a LAN port to connect with your network
14	<i>[RS232/485PORT]</i> D-Sub socket for remote control or for the cascading of several devices
15	<i>[OUTPUTS]</i> XLR chassis plugs for the output channels. The number of channels depends on the device design.
16	<i>[INPUTS]</i> XLR chassis sockets for the output channels. The number of channels depends on the device design.

6 Operating on the unit

Starting the device

Connect the device to the power grid and turn it on with the main switch to start operation. After a few seconds, the display indicates that a reset is in progress. The device is then ready for use. The display shows the model name and the user preset that's currently active.

The device can only be operated directly with the buttons if it is not being controlled via USB, LAN or the serial interface.

The buttons that can currently be used light up continuously, and the most previously used ones flash on and off. Buttons that cannot be used at the moment remains dark.

Default settings

1. ➤ Keep pressing *[UTIL]* until the parameter you want appears in the display. The table below shows the available parameters and their ranges.
2. ➤ Use the jog wheel to set the desired value of the parameter. Press the jog wheel to confirm.
3. ➤ Press *[EXIT]*.

Parameter	Selection range	Meaning
'ID Number Select'	'1' ... '254'	Unique identification of the device when connected serially (in a cascade configuration). If several devices are connected serially, each of them must have a unique ID number.
'Manual IP Set'		If the device is connected to a local network, its IP address can be set individually. The initial IP address is 192.168.1.101.
'Unit Lock PassWord'	'0000' ... 'ZZZZ'	Four-character device password. Any combination of letters or numbers can be set. The initial password is 1234.
'Input Source Select'	'ANALOG INPUT', 'PINK NOISE', 'WHITE NOISE', 'SINE xx'	Selection of the signal source: Either the analogue inputs or the internal test tone generator. The test tone generator can produce either: pink noise, white noise or a sine wave of 20 Hz...20 kHz.
'Copy CH select'		Copies the settings from one channel to another.
'Delay Units Select'	'ms', 'm', 'ft'	Selects the unit for displaying the delay: Milliseconds, metres or feet.

User presets

All device settings can be saved in up to 20 different user presets and then recalled as needed. That way you can easily restore your settings for different rooms or stage set-ups.

Save use preset

- 1.** ▶ Press *[SAVE]*.
⇒ The *'Store Preset'* menu opens.
- 2.** ▶ Use the jog wheel to select a user preset between *'U01'* and *'U20'*. Press the jog wheel to confirm.
- 3.** ▶ Using the jog wheel, enter the name of the user preset by changing the *Default Preset* standard value.
⇒ The settings are saved.
- 4.** ▶ Press *[EXIT]*.

Call up user preset

- 1.** ▶ Press *[RECALL]*.
⇒ The *'Load preset'* menu opens.
- 2.** ▶ Use the jog wheel to select a user preset between *'U01'* and *'U20'* or the basic setting *'F00'*. Press the jog wheel to confirm.
⇒ The settings are loaded.

Input settings

1. ➤ Press the [EDIT] button assigned to the desired channel.
 ⇒ The settings menu for the desired channel will open. The display shows 'GAIN'.
2. ➤ In the basic state of the menu, you can set the level of the channel within a range of -60 dB...+12 dB using the jog wheel.
3. ➤ Press the respective button to set further parameters for the channel.
 Use the jog wheel to set the desired value of the parameter. Press the jog wheel to confirm.

The table below shows the available parameters and their ranges.

Parameter	Button	Selection range	Meaning
'PEQ'	1 × [PEQ/GEQ]	'PEQ': '1' ... '9' 'F': '20Hz' ... '20kHz' 'Q': '0.4' ... '128' 'G': '-12dB' ... '+12dB' 'Style': 'PEAK', 'L-SHLF', 'H-SHLF', 'LP6dB', 'LP12dB', 'HP6dB', 'HP12dB', 'A-PAS1', 'A-PAS2' 'ON', 'BP'	For 9 frequency bands (numbered with the parameter 'PEQ'), the parameters of the parametric equalizer can be set individually: Centre frequency, filter quality, slope, filter type, bypass
'GEQ'	2 × [PEQ/GEQ]	'Freq': '20Hz' ... '20kHz' 'Gain': '-12dB' ... '+12dB'	Graphic equalizer parameters: The frequency range is divided into 31 fixed preset areas (numbered with the parameter 'GEQ'), which can be set separately for boost or cut.
'INLINK'	[LINK]		The settings of several input channels can be linked to each other. The number of input channels depends on the device design.
'DELAY'	[DELAY]	'0ms' ... '680ms' '0m' ... '234m' '0ft' ... '766ft'	Delay time. The units that are displayed depends on the device's default setting.
'X-OVER'	[X-OVER]	'HP': '20Hz' ... '20kHz' 'LP': '20Hz' ... '20kHz' 'BUTTER-xx' (Butterworth), 'BESSEL-xx' (Bessel), 'LINK/R-xx' (Linkwitz-Riley), 'BYPASS' (Filter switched off)	Parameters for digital high pass and low pass: Cut-off frequency, slope and filter type

Parameter	Button	Selection range	Meaning
'GATE'	[COMP/ GATE]	'T': '-90dB' ... '-0dB' 'HT': '10' ... '999' (in milliseconds) 'AT': '1ms' ... '999ms' 'RT': '10ms' ... '3000ms'	Parameters for the noise gate: Threshold, hold, attack, release
'PHASE'	[PHASE]	'0', '180'	Inversion of phase length

Output settings

1. ➤ Press the [EDIT] button assigned to the desired channel.
⇒ The settings menu for the desired channel will open. The display shows 'GAIN'.
2. ➤ In the basic state of the menu, you can set the level of the channel within a range of -60 dB...+12 dB using the jog wheel.
3. ➤ Press the respective button to set further parameters for the channel.
Use the jog wheel to set the desired value of the parameter. Press the jog wheel to confirm.

The table below shows the available parameters and their ranges.

Parameter	Button	Selection range	Meaning
'PEQ'	1 × [PEQ/GEQ]	'PEQ': '1' ... '9' 'F': '20Hz' ... '20kHz' 'Q': '0.4' ... '128' 'G': '-12dB' ... '+12dB' 'Style': 'PEAK', 'L-SHLF', 'H-SHLF', 'LP6dB', 'LP12dB', 'HP6dB', 'HP12dB', 'A-PAS1', 'A-PAS2' 'ON', 'BP'	For 9 frequency bands (numbered with the parameter 'PEQ'), the parameters of the parametric equalizer can be set individually: Centre frequency, filter quality, slope, filter type, bypass
'INLINK'	[LINK]		The settings of several output channels can be linked to each other. The number of output channels depends on the device design.
'DELAY'	[DELAY]	'0ms' ... '680ms' '0m' ... '234m' '0ft' ... '766ft'	Delay time. The units that are displayed depends on the device's default setting.
'X-OVER'	[X-OVER]	'HP': '20Hz' ... '20kHz' 'LP': '20Hz' ... '20kHz' 'BUTTER-xx' (Butterworth), 'BESSEL-xx' (Bessel), 'LINK/R-xx' (Linkwitz-Riley), 'BYPASS' (Filter switched off)	Parameters for digital high pass and low pass: Cut-off frequency, slope and filter type
'MATRIX'	1 × 'MATRIX'		Selection of the assignment of the input channels to the respective output channel. Each output channel can be freely assigned to one input channel or a mix of several input channels. The selected input channels are marked with 'X'.
'MATRIX Output'	2 × 'MATRIX'	'-60dB' ... '+0dB'	One level adjustment can be set for each of the input channels assigned to the respective output channel.

Parameter	Button	Selection range	Meaning
'GATE'	1 × [COMP/ GATE]	'T': '-90dB' ... '-0dB' 'HT': '10ms' ... '999ms' 'AT': '1ms' ... '999ms' 'RT': '10ms' ... '3000ms'	Parameters for the noise gate: Threshold, hold, attack, release
'LIMIT'	2 × [COMP/ GATE]	'TH': '-90dB' ... '+20dB' 'AT': '1ms' ... '999ms' 'RT': '10ms' ... '3000ms'	Parameters for the limiter: Threshold, attack, release
'PHASE'	[PHASE]	'0', '180'	Inversion of phase length

7 Control on the computer

Installing and starting the software

1. ➤ Place the CD with the software into the CD drive of a computer with a Windows operating system and start the installation programme that matches the device you have.
2. ➤ Follow the instructions of the installation programme until it is finished.
3. ➤ Connect your computer via a USB cable to the device and switch the device on.
⇒ The operating system recognizes the newly added USB device.
4. ➤ Open the computer programme. It automatically recognized the attached device.
⇒ The 'Online' marking will appear in the upper right corner of the programme window.

Closing the software

1. ➤ Click on the 'Online' button in the programme window.
2. ➤ Close the programme window.

Parts of the programme window

All of the programme window tabs have a similar design and are grouped into the following areas:

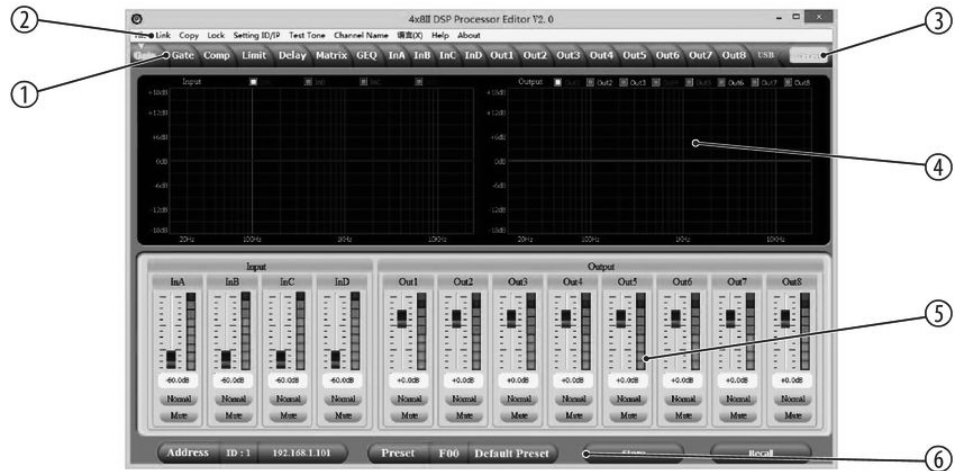

1	Buttons for selecting a function group
2	Main menu
3	Button for the status of the connection to the computer
4	Display area
5	Control area
6	Buttons for quick access to the important presets

Main menu

Menu item	Meaning
'File'	Load user presets and save them on the computer
'Link'	Assign input and output channels
'Copy'	Copy parameter settings from one input or output channel to another
'Lock'	Change device password
'Setting ID/IP'	Change unique ID of the device in a serial configuration or IP address for integrating into a local network
'Test tone'	Setting of the internal test tone generator: Pink noise, white noise, sine wave 20 Hz...20 kHz.
'Channel name'	Rename the input and output channels
'Language'	Language selection for the programme user interface (English or Chinese)
'Help'	Display of the control code for the serial interface
'About'	Information about the programme version

Buttons for quick access to the important presets

Range	Meaning
Address	Display of the ID of the device in a serial configuration or IP address for integrating into a local network
Preset	Display of the current user preset
Store	Save user preset
Recall	Call up user preset

“Gain” tab

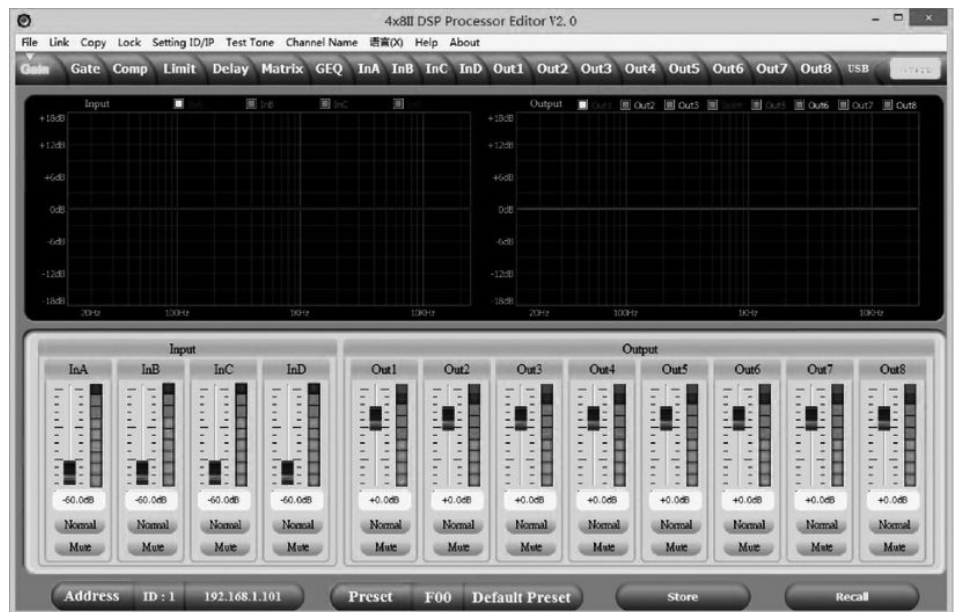

Range	Meaning
Display area	The signal curve of the input and output channels is displayed graphically. Use the 'Inx' and 'Outx' option fields to set the inputs and outputs that should be displayed.
Control area	Drag the fader with the mouse to set the limits for the input and output channels: The 'Mute' button mutes or unmutes the respective channel. The 'Normal' / 'Inverse' button inverts the phase of the respective channel by 180° if needed.

“Gate” tab

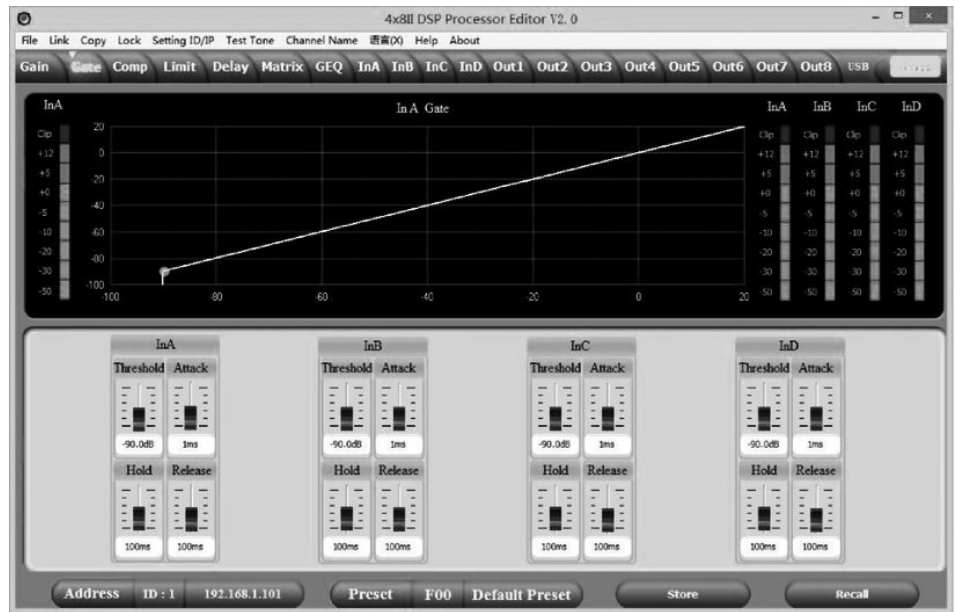

Range	Meaning
Display area	Shows the current settings of the noise gate for the respective channel, with a symbolic level indicator symbol appearing next to it for the input channels. The red dot on the curve represents the current signal.
Control area	Drag the fader with the mouse to set the noise gate parameters for all input and output channels: Threshold, hold, attack, release

"Comp" tab

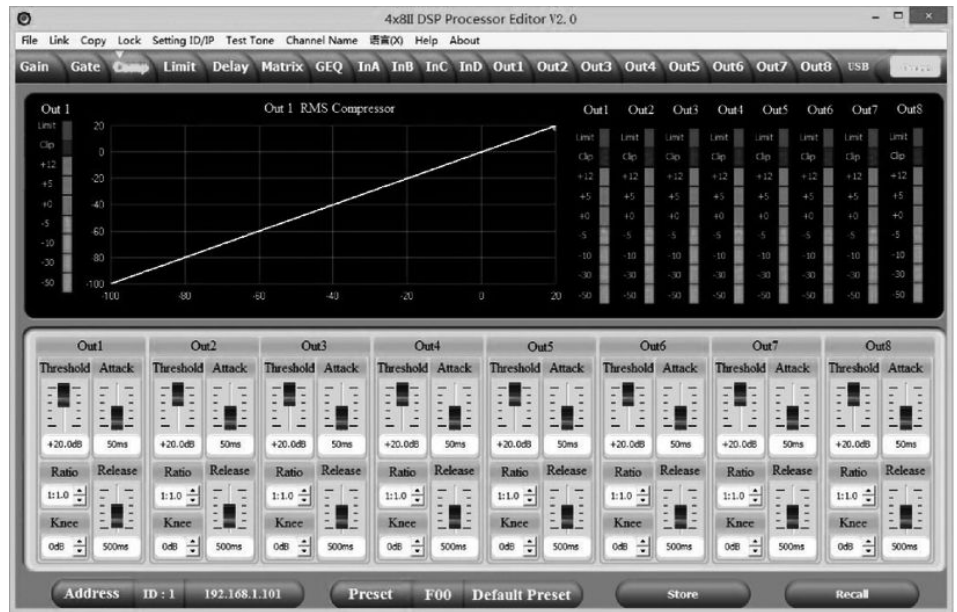

Range	Meaning
Display area	Shows the current settings of the compressor function for the respective output channel, with a symbolic level indicator symbol appearing next to it for the input channels. The red dot on the curve represents the current signal.
Control area	Drag the fader with the mouse to set the compressor function parameters for all output channels: Compression, threshold, ratio, attack, release

“Limit” tab

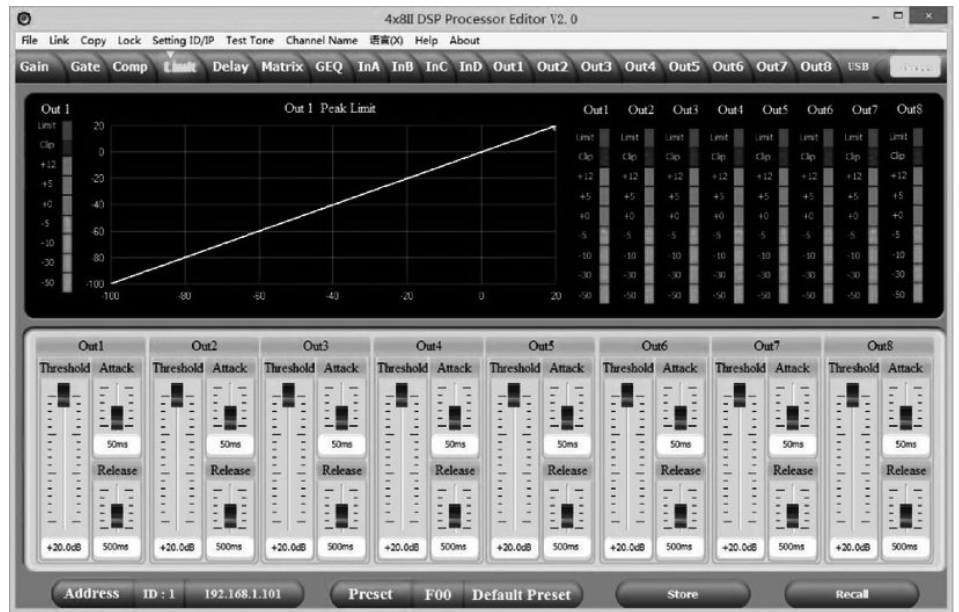

Range	Meaning
Display area	Shows the current settings of the limiter for the respective channel, with a symbolic level indicator symbol appearing next to it for all channels.
Control area	Drag the fader with the mouse to set the limiter parameters for all input and output channels: Threshold, attack, release

"Delay" tab

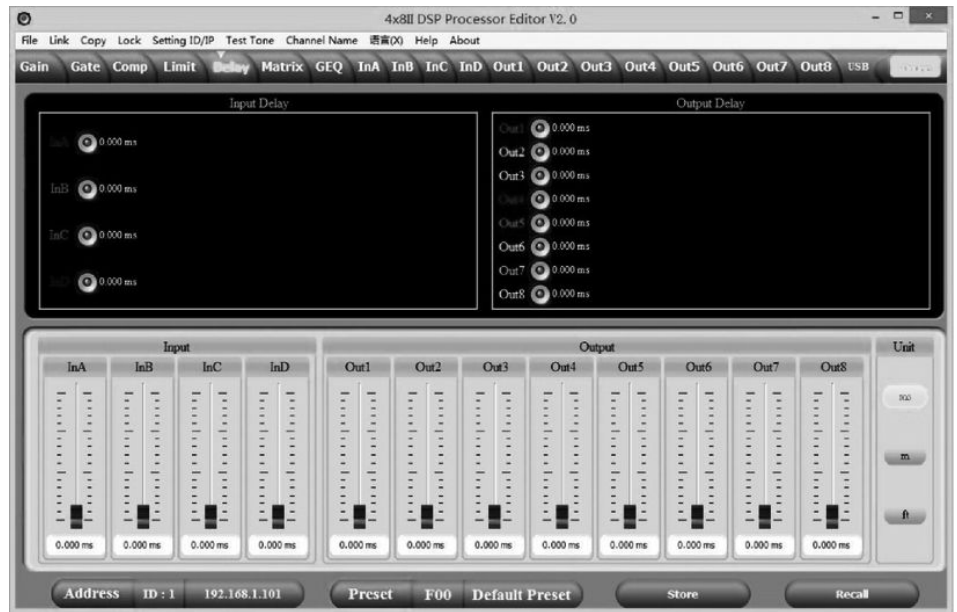

Range	Meaning
Display area	Shows the set delays for all input and output channels.
Control area	Drag the fader with the mouse to set the delay for the respective channel. Press one of the buttons 'ms', 'm' or 'ft' to select the unit to use.

“Matrix” tab

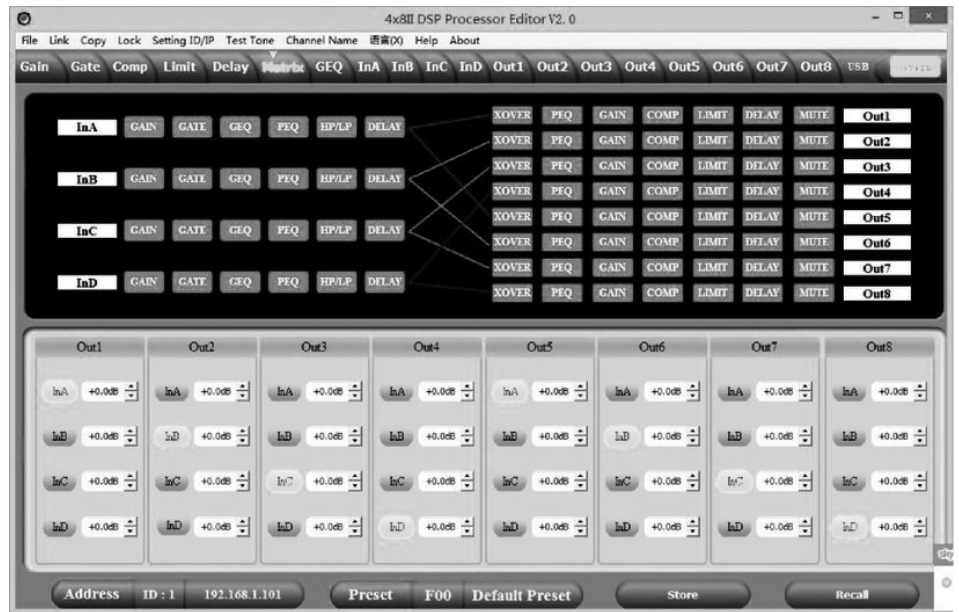

Range	Meaning
Display area	Shows the current configuration of input to output channels. Output and input channels can be renamed. Click on a function area (e.g. ‘GEQ’ or ‘DELAY’) to open the tab in which you can directly enter the corresponding parameters.
Control area	By clicking with the mouse you can connect any input channel to any output channel. Each output channel can be freely assigned to one input channel or a mix of several input channels. The input channels with a green background are assigned to the respective output channel. You can set a level adjustment for any combination of input and output channel.

"GEQ" tab

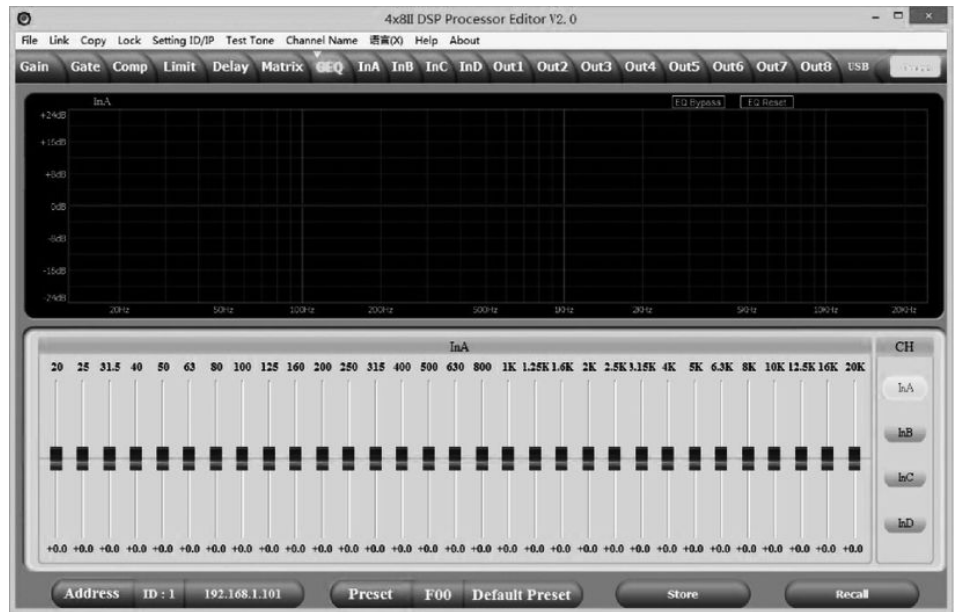

Range	Meaning
Display area	Shows the setting of the graphic equalizer for the selected input channel. Click on the 'EQ Bypass' button to temporarily switch off the equalizer function for this channel or on the 'EQ Reset' button to return the equalizer to its basic status.
Control area	Drag the fader with the mouse to set the boost or cut for each of the available frequency bands. To select a channel, click on the buttons 'InA' ... 'InD'. The number of input channels depends on the device design.

“In” tab

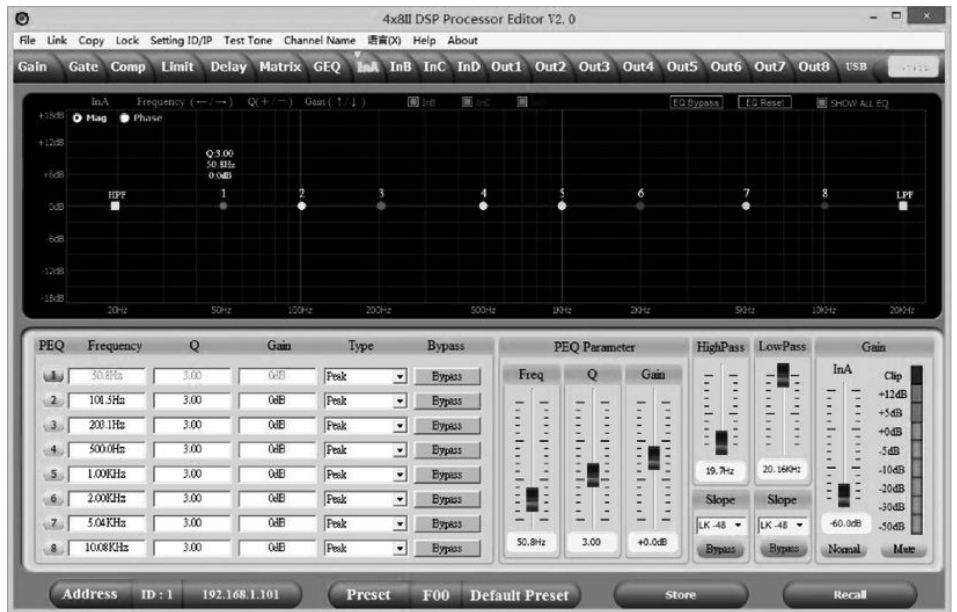

Range	Meaning
Display area	<p>Use the option fields 'Mag' and 'PHASE' to switch the diagram from Cartesian coordinates (level vs. frequency) to polar coordinates (angle vs. frequency).</p> <p>Use the option field 'SHOW ALL EQ' to show the parameters for all nine of the frequency bands.</p>
Control area	<p>You can enter the parameters of the parametric equalizer for each input channel and all nine frequency bands (numbered with 'PEQ') in the left part of the window directly as numerical values: Centre frequency, filter quality, slope, filter type. With the 'Bypass' button, the equalizer for the respective frequency band and the respective channel can be temporarily switched off.</p> <p>In the middle part of the window ('PEQ Parameter') you can set the parameters centre frequency, filter quality, and slope unit using the faders. The setting is based on the frequency band that is high-lighted green in the left part of the window.</p> <p>You can select the cut-off frequency and the filter type for the low pass and the high pass filter. Use the 'Bypass' button to temporarily switch off the filter.</p> <p>Drag the fader into the right part of the window using the mouse to set the level for the input channel. The 'Mute' button mutes or unmutes the respective channel. The 'Normal' / 'Inverse' button shifts the phase of the respective channel by 180° if needed.</p>

"Out" tab

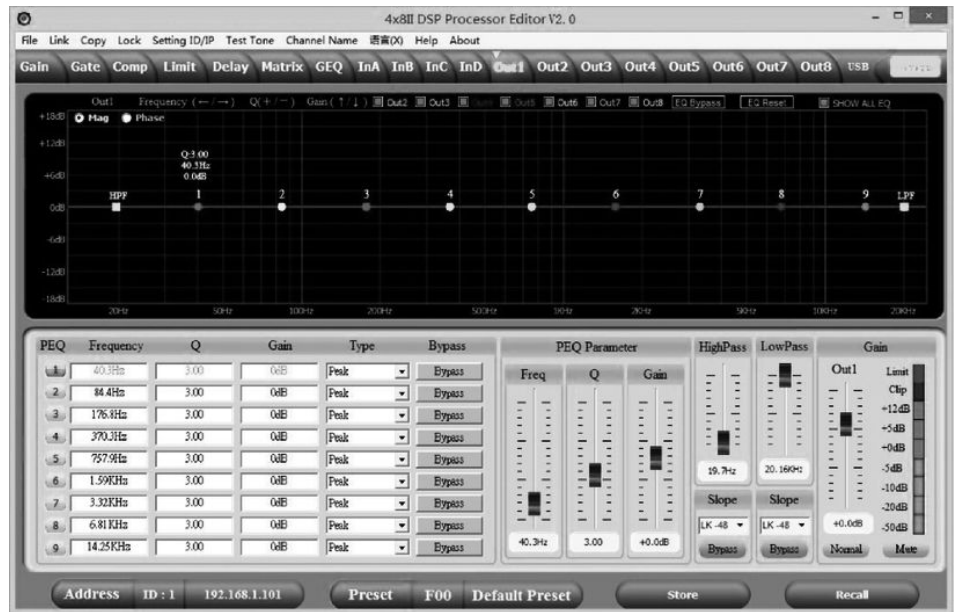

Range	Meaning
Display area	<p>Use the option fields 'Mag' and 'PHASE' to switch the diagram from Cartesian coordinates (level vs. frequency) to polar coordinates (angle vs. frequency).</p> <p>Use the option field 'SHOW ALL EQ' to show the parameters for all nine of the frequency bands.</p>
Control area	<p>You can enter the parameters of the parametric equalizer for each input channel and all nine frequency bands (numbered with 'PEQ') in the left part of the window directly as numerical values: Centre frequency, filter quality, slope, filter type. With the 'Bypass' button, the equalizer for the respective frequency band and the respective channel can be temporarily switched off.</p> <p>In the middle part of the window ('PEQ Parameter') you can set the parameters centre frequency, filter quality, and slope unit using the faders. The setting is based on the frequency band that is high-lighted green in the left part of the window.</p> <p>You can select the cut-off frequency and the filter type for the low pass and the high pass filter. Use the 'Bypass' button to temporarily switch off the filter.</p> <p>Drag the fader into the right part of the window using the mouse to set the level for the input channel. The 'Mute' button mutes or unmutes the respective channel. The 'Normal' / 'Inverse' button shifts the phase of the respective channel by 180° if needed.</p>

8 Technical specifications

Inputs	Type	XLR	
	Level	+18 dBu (max.)	
	Impedance	1 M Ω (stereo), 500 k Ω (mono)	
Outputs	Type	XLR	
	Level	+20 dBu (max.)	
	Impedance	< 500 Ω	
Frequency response		20 Hz ... 20 kHz	
THD		< 0.005 % (1 kHz, 0 dBu)	
Signal-to-noise ratio		> 115 dBu	
Crosstalk		< 100 dB	
Digital signal processor	Resolution	24 bit	
	Sampling rate	96 kHz	
Voltage supply		AC 100 – 240 V~ 50/60 Hz	
Power consumption		20 W	
Fuse		5 mm × 20 mm, 2 A, 250 V, slow-blow	
Dimensions (W × H × D)		480 × 45 × 24.5 mm	
Weight		2.62 kg	
Ambient conditions		Temperature range	0 °C...40 °C
		Relative humidity	50 %, non-condensing

Further information

	DSP 204 (Item no. 435191)	DSP 206 (Item no. 435192)	DSP 306 (Item no. 435193)	DSP 408 (Item no. 435194)
2-way stereo	Yes	Yes	Yes	Yes
3-way stereo	No	Yes	Yes	Yes
Digital	Yes	Yes	Yes	Yes
Delay	Yes	Yes	Yes	Yes
EQ	Yes	Yes	Yes	Yes

Block diagram

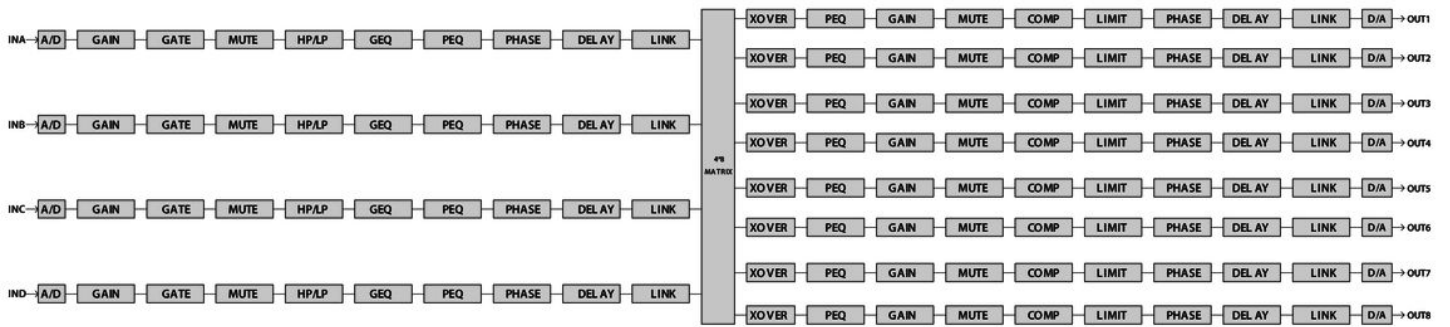

9 Plug and connection assignment

Introduction

This chapter will help you select the right cables and plugs to connect your valuable equipment in such a way that a perfect sound experience is ensured.

Please note these advices, because especially in 'Sound & Light' caution is indicated: Even if a plug fits into the socket, an incorrect connection may result in a destroyed power amp, a short circuit or 'just' in poor transmission quality!

XLR plug (balanced)

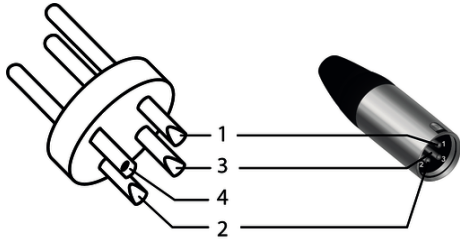

1	Ground, shielding
2	Signal (in phase, +)
3	Signal (out of phase, -)
4	Shielding on plug housing (option)

10 Protecting the environment

Disposal of the packaging material



For the transport and protective packaging, environmentally friendly materials have been chosen that can be supplied to normal recycling.

Ensure that plastic bags, packaging, etc. are properly disposed of.

Do not just dispose of these materials with your normal household waste, but make sure that they are collected for recycling. Please follow the notes and markings on the packaging.

Disposal of your old device



This product is subject to the European Waste Electrical and Electronic Equipment Directive (WEEE) in its currently valid version. Do not dispose with your normal household waste.

Dispose of this device through an approved waste disposal firm or through your local waste facility. When discarding the device, comply with the rules and regulations that apply in your country. If in doubt, consult your local waste disposal facility.

