



Giga Bar HEX 3  
Giga Bar HEX 3 BAT

LED bar

Musikhaus Thomann  
Thomann GmbH  
Hans-Thomann-Straße 1  
96138 Burgebrach  
Germany  
Telephone: +49 (0) 9546 9223-0  
E-mail: [info@thomann.de](mailto:info@thomann.de)  
Internet: [www.thomann.de](http://www.thomann.de)

06.05.2020, ID: 472654, 472655

# Table of contents

<b>1</b>	<b>General information</b> .....	<b>6</b>
	1.1 Further information.....	7
	1.2 Notational conventions.....	8
	1.3 Symbols and signal words.....	9
<b>2</b>	<b>Safety instructions</b> .....	<b>12</b>
<b>3</b>	<b>Features</b> .....	<b>20</b>
<b>4</b>	<b>Installation</b> .....	<b>21</b>
<b>5</b>	<b>Starting up</b> .....	<b>25</b>
<b>6</b>	<b>Connections and controls</b> .....	<b>28</b>
<b>7</b>	<b>Operating</b> .....	<b>35</b>
	7.1 Starting the device.....	35
	7.2 Operating on the unit.....	35
	7.3 Menu overview.....	44
	7.4 Functions in 3-channel DMX mode.....	45
	7.5 Functions in 4-channel DMX mode.....	45

7.6	Functions in 6-channel DMX mode.....	46
7.7	Functions in 9-channel DMX mode.....	47
7.8	Functions in 11-channel DMX mode.....	48
<b>8</b>	<b>Technical specifications.....</b>	<b>50</b>
<b>9</b>	<b>Plug and connection assignments.....</b>	<b>54</b>
<b>10</b>	<b>Troubleshooting.....</b>	<b>55</b>
<b>11</b>	<b>Cleaning.....</b>	<b>57</b>
<b>12</b>	<b>Protecting the environment.....</b>	<b>58</b>



Giga Bar HEX 3 Giga Bar HEX 3 BAT  
LED bar

# 1 General information

This user manual contains important information on the safe operation of the device. Read and follow all safety notes and all instructions. Save this manual for future reference. Make sure that it is available to all persons using this device. If you sell the device to another user, be sure that they also receive this manual.

Our products and user manuals are subject to a process of continuous development. We therefore reserve the right to make changes without notice. Please refer to the latest version of the user manual which is ready for download under [www.thomann.de](http://www.thomann.de).

## 1.1 Further information

On our website ([www.thomann.de](http://www.thomann.de)) you will find lots of further information and details on the following points:

Download	This manual is also available as PDF file for you to download.
Keyword search	Use the search function in the electronic version to find the topics of interest for you quickly.
Online guides	Our online guides provide detailed information on technical basics and terms.
Personal consultation	For personal consultation please contact our technical hotline.
Service	If you have any problems with the device the customer service will gladly assist you.

## 1.2 Notational conventions

This manual uses the following notational conventions:

### Letterings

The letterings for connectors and controls are marked by square brackets and italics.

**Examples:** *[VOLUME]* control, *[Mono]* button.

### Displays

Texts and values displayed on the device are marked by quotation marks and italics.

**Examples:** *'24ch'*, *'OFF'*.



## Instructions



The individual steps of an instruction are numbered consecutively. The result of a step is indented and highlighted by an arrow.



### Example:

1. ▶ Switch on the device.
2. ▶ Press *[Auto]*.
  - ⇒ Automatic operation is started.
3. ▶ Switch off the device.

## 1.3 Symbols and signal words

In this section you will find an overview of the meaning of symbols and signal words that are used in this manual.

Signal word	Meaning
<b>DANGER!</b>	This combination of symbol and signal word indicates an immediate dangerous situation that will result in death or serious injury if it is not avoided.
<b>WARNING!</b>	This combination of symbol and signal word indicates a possible dangerous situation that can result in death or serious injury if it is not avoided.
<b>NOTICE!</b>	This combination of symbol and signal word indicates a possible dangerous situation that can result in material and environmental damage if it is not avoided.
Warning signs	Type of danger
	Warning – high-voltage.
	Warning – dangerous optical radiation.

Warning signs	Type of danger
	<p>Warning – suspended load.</p>
	<p>Warning – danger zone.</p>

## 2 Safety instructions

### **Intended use**

This device is intended for use as an electronic lighting effect by means of LED technology. The device is designed for professional use and is not suitable for use in households. Use the device only as described in this user manual. Any other use or use under other operating conditions is considered to be improper and may result in personal injury or property damage. No liability will be assumed for damages resulting from improper use.

This device may be used only by persons with sufficient physical, sensorial, and intellectual abilities and having corresponding knowledge and experience. Other persons may use this device only if they are supervised or instructed by a person who is responsible for their safety.

Extend the life of the device by regular breaks in operation and avoid switching it on and off frequently. This device is not suitable for continuous use.

**Safety****DANGER!****Danger for children**

Ensure that plastic bags, packaging, etc. are disposed of properly and are not within reach of babies and young children. Choking hazard!

Ensure that children do not detach any small parts (e.g. knobs or the like) from the unit. They could swallow the pieces and choke!

Never let children unattended use electrical devices.

**DANGER!****Electric shock caused by high voltages inside**

Within the device there are areas where high voltages may be present. Never remove any covers.

There are no user-serviceable parts inside.

Do not use the device if covers, protectors or optical components are missing or damaged.



**DANGER!**

**Electric shock caused by short-circuit**

Always use proper ready-made insulated mains cabling (power cord) with a protective contact plug. Do not modify the mains cable or the plug. Failure to do so could result in electric shock/death or fire. If in doubt, seek advice from a registered electrician.



**WARNING!**

**Eye damage caused by high light intensity**

Never look directly into the light source.



**WARNING!**

**Risk of epileptic shock**

Strobe lighting can trigger seizures in photosensitive epilepsy. Sensitive persons should avoid looking at strobe lights.



**WARNING!**

**Incorrect handling of lithium batteries can result in injury**

In the event of a short circuit, overheating or mechanical damage, lithium batteries can cause severe injuries.

Follow the advice on the correct handling of lithium batteries in the present section.



**NOTICE!**

**Risk of fire**

Do not block areas of ventilation. Do not install the device near any direct heat source. Keep the device away from naked flames.



### **NOTICE!**

#### **Operating conditions**

This device has been designed for indoor use only. To prevent damage, never expose the device to any liquid or moisture. Avoid direct sunlight, heavy dirt, and strong vibrations.

Only operate the device within the ambient conditions specified in the chapter 'Technical specifications' of this user manual. Avoid heavy temperature fluctuations and do not switch the device on immediately after it was exposed to temperature fluctuations (for example after transport at low outside temperatures).

Dust and dirt inside can damage the unit. When operated in harmful ambient conditions (dust, smoke, nicotine, fog, etc.), the unit should be maintained by qualified service personnel at regular intervals to prevent overheating and other malfunction.





**NOTICE!**

**Power supply**

Before connecting the device, ensure that the input voltage (AC outlet) matches the voltage rating of the device and that the AC outlet is protected by a residual current circuit breaker. Failure to do so could result in damage to the device and possibly injure the user.

Unplug the device before electrical storms occur and when it is unused for long periods of time to reduce the risk of electric shock or fire.



**NOTICE!**

**Possible damage due to installation of a wrong fuse**

The use of different types of fuses can cause serious damage to the unit. Fire hazard!

Only fuses of the same type may be used.



### **NOTICE!**

#### **Risk of fire due to incorrect polarity**

Incorrectly inserted batteries may destroy the device or the batteries.

Ensure that proper polarity is observed when inserting batteries.



### **NOTICE!**

#### **Possible damage by leaking batteries**

Leaking batteries can cause permanent damage to the device.

Take batteries out of the device if it is not going to be used for a longer period.

**NOTICE!****Possible damage due to incorrect storage**

Deep discharge can cause batteries to become permanently damaged or lose some of their capacity.

Before prolonged rest periods, charge the batteries to around 50 % of their capacity and then switch the equipment off. Store the equipment at a temperature between 10 °C and 32 °C in as dry an environment as possible. During extended storage periods, charge the batteries to 50 % approximately every three months.

### 3 Features

Special features of the device:

- LED BAR with 3 × RGBAWUV LED, 6-in-1, 12 W each
- Mains operation (item no. 472654) or battery operation (item no. 472655)
- Operating modes:
  - Automatic
  - DMX
  - Master/Slave
  - Sound control via built-in microphone
- Control via DMX (five different modes), via the supplied infrared remote and via buttons and display on the unit

For technological reasons, the light output of LEDs decreases over their lifetime. This effect increases with higher operating temperature. You can extend the service life of the illuminants by providing adequate ventilation and operating the LEDs with the lowest possible brightness.

## 4 Installation

Unpack and check carefully there is no transportation damage before using the unit. Keep the equipment packaging. To fully protect the product against vibration, dust and moisture during transportation or storage use the original packaging or your own packaging material suitable for transport or storage, respectively.



### **WARNING!**

#### **Risk of injury caused by falling objects**

Make sure that the installation complies with the standards and rules that apply in your country. Always secure the device with a secondary safety attachment, such as a safety cable or a safety chain.



### **NOTICE!**

#### **Risk of overheating**

The distance between light output and the illuminated surface must be more than 1.5 m (19.7in).

Provide sufficient ventilation.

The ambient temperature must always be below 40 °C (104 °F).



### **NOTICE!**

#### **Possible data transmission errors**

For error-free operation make use of dedicated DMX cables and do not use ordinary microphone cables.

Never connect the DMX input or output to audio devices such as mixers or amplifiers.

## Mounting options

You can install the unit in hanging or standing position. When in use, the device must always be attached to a solid surface or an approved truss.

Always work from a stable platform whenever installing, moving or servicing the unit. In doing so, the area underneath the unit must be cordoned off.

The safety cable must be attached to the safety eyelet.



*Please note that this device must not be connected to a dimmer.*

### Inserting batteries into the remote

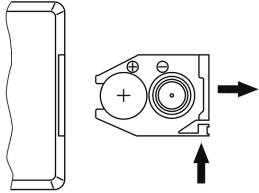

Push the lock of the battery holder towards the centre of the housing and pull out the battery holder like a drawer. Insert the batteries in the correct polarity according to the marking on the remote. Slide the battery holder back into the remote until it clicks into place.

When shipping, the batteries are already installed in the remote and protected against discharge by a transparent plastic film. Remove the plastic film before initial use.



## 5 Starting up

Create all connections while the device is off. Use the shortest possible high-quality cables for all connections. Take care when running the cables to prevent tripping hazards.

### Connections in DMX mode

Connect the DMX input of the device to the DMX output of a DMX controller or another DMX device. Connect the output of the first DMX device to the input of the second one, and so on to form a daisy chain. Always ensure that the output of the last DMX device in the daisy chain is terminated with a resistor ( $110\ \Omega$ ,  $\frac{1}{4}\text{ W}$ ).

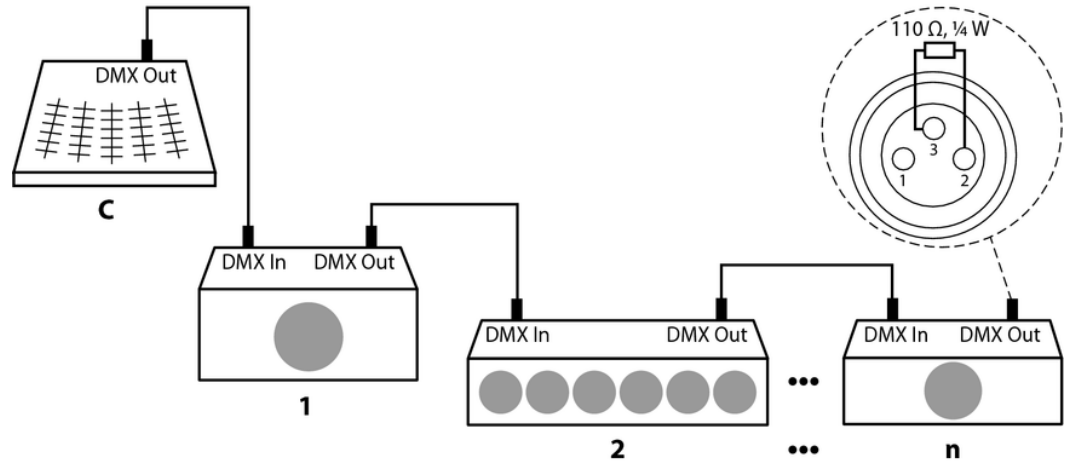

**Connections in master/slave mode**

When you configure a group of devices in master/slave mode, the first unit will control the other units for an automatic, sound-activated, synchronized show. This function is ideal when you want to start a show immediately. Connect the DMX output of the master device to the DMX input of the first slave device. Then connect the DMX output of the first slave device to the DMX input of the second slave device and so on.

## 6 Connections and controls

### Front panel

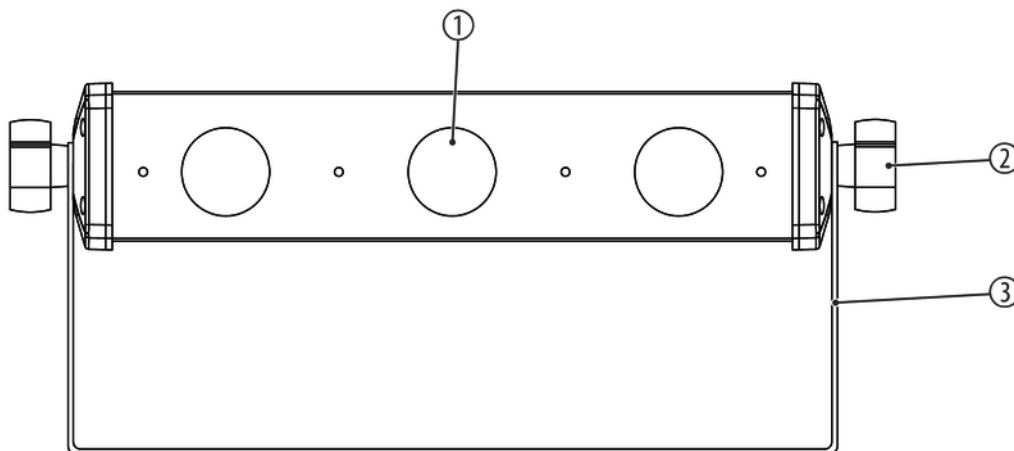

1	LED
2	Locking screw for mounting bracket
3	Mounting bracket

The infrared sensor for the remote control signals is located beneath the right lens.

## Rear panel

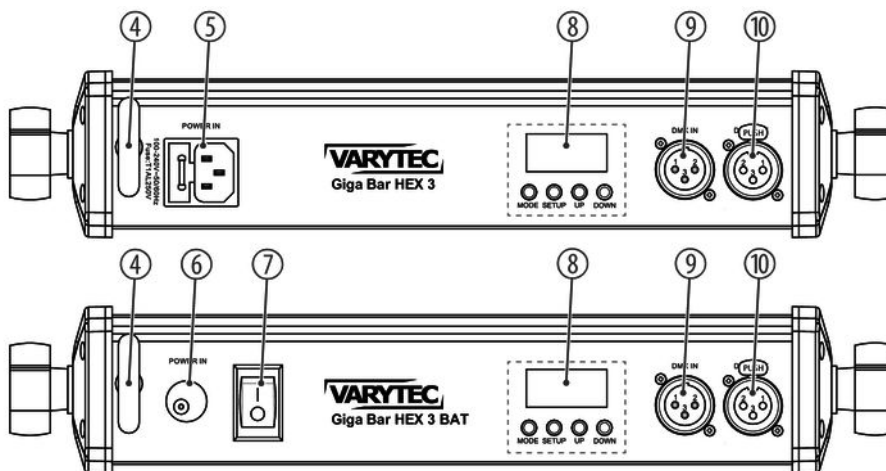

- |   |   |
|---|---|
| 4 | Safety eyelet for fastening the safety cable        |
| 5 | IEC chassis plug with fuse holder (item no. 472654) |

6	Power supply connection socket for charging the battery (item no. 472655)
7	On / off switch (item no. 472655)
8	Display
	<i>[MODE]</i> Calls up the main menu and exits an opened submenu.
	<i>[SETUP]</i> Selects an option of the respective operating mode, confirms the set value.
	<i>[UP]</i> Toggles between the menu items of a menu level, increases the displayed value by one.
	<i>[DOWN]</i> Toggles between the menu items of a menu level, decreases the displayed value by one.

9	<i>[DMX IN]</i> DMX input
10	<i>[DMX OUT]</i> DMX output



## Remote control

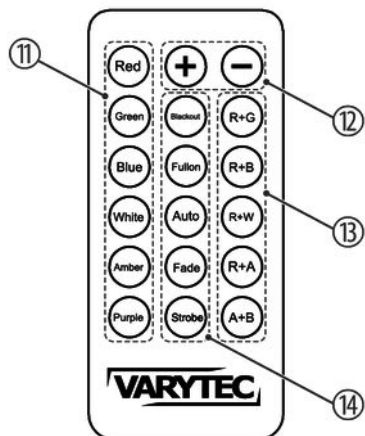

11 Buttons to select a single basic colour

12 [+], [-]

Changes the auto or fade programmes, increases or decreases the strobe speed

13 Selection of a mixed colour

14 Function selection

*[Blackout]*

Button to turn the blackout on or off

*[Strobe]*

Turns the Strobe effect (flash) on or off

*[Fullon]*

Turns all colours to full brightness

*[Auto]*

Starts a preprogrammed automatic show

*[Fade]*

Turns the Fade effect (colour transition) on or off

## 7 Operating

### 7.1 Starting the device

Connect the device to the power grid.

Turn on the power using the main switch. The display shows the current operation mode.

### 7.2 Operating on the unit

#### Menu control

1. ▶ Press *[MODE]* to open the main menu or to return to the main menu.
2. ▶ Use *[UP]* or *[DOWN]* to select the desired submenu, parameter or value.
3. ▶ Confirm the selection with *[SETUP]*.
  - ⇒ The selected submenu opens up or the selected value is being accepted.

To return to the next higher menu level without changes, press *[MODE]*.

**DMX address**

Use 'Addr' to select the start address channel for the DMX address.

1. ➤ Press [MODE] and use [UP] or [DOWN] to select the submenu 'Addr'.
2. ➤ Confirm the selection with [SETUP].
3. ➤ Use [UP] or [DOWN] to select the desired start address from 'A001' ... 'A512'.
4. ➤ Confirm the selection with [SETUP].  
⇒ The selected start address is accepted.

DMX mode	Highest possible start address
3-channel mode	510
4-channel mode	509
6-channel mode	507
9-channel mode	504
11-channel mode	502

### DMX mode

Use '*Chnd*' to select the DMX mode.

1. ➤ Press [*MODE*] and use [*UP*] or [*DOWN*] to select the submenu '*Chnd*'.
2. ➤ Confirm the selection with [*SETUP*].
3. ➤ Use [*UP*] or [*DOWN*] to select the desired DMX mode.
  - '*CH 3*' (3 channels)
  - '*CH 4*' (4 channels)
  - '*CH 6*' (6 channels)
  - '*CH 9*' (9 channels)
  - '*CH 11*' (11 channels)
4. ➤ Confirm the selection with [*SETUP*].
  - ⇒ The selected setting is accepted.

### Manual dimmer

Use '*MANU*' to manually dim the colours.

1. ➤ Press [*MODE*] and use [*UP*] or [*DOWN*] to select the submenu '*MANU*'.
2. ➤ Confirm the selection with [*SETUP*].

3. ➤ Use *[UP]* or *[DOWN]* to select the desired colour; display shows 'red', 'Gree', 'bLue', 'Uhte', 'YeLL', 'UV'.
4. ➤ Confirm the selection with *[SETUP]*.
5. ➤ Use *[UP]* or *[DOWN]* to select the desired intensity in a range from '000...255'.
6. ➤ Confirm the selection with *[SETUP]*.  
⇒ The selected setting is accepted.

### Colour selection

Use 'CoLo' to select one of 32 mixed colours.

1. ➤ Press *[MODE]* and use *[UP]* or *[DOWN]* to select the submenu 'CoLo'.
2. ➤ Confirm the selection with *[SETUP]*.
3. ➤ Use *[UP]* or *[DOWN]* to select the desired mixed colour; display shows 'Co 1...Co 32'.
4. ➤ Confirm the selection with *[SETUP]*.  
⇒ The selected setting is accepted.

### Operating mode Auto

Use 'AUto' to select five automatic programmes and set a running speed.

1. ➤ Press *[MODE]* and use *[UP]* or *[DOWN]* to select the submenu 'AUto'.
2. ➤ Confirm the selection with *[SETUP]*.
3. ➤ Use *[UP]* or *[DOWN]* to select the desired auto programme; display shows 'SH-1...SH-5'.
4. ➤ Confirm the selection with *[SETUP]*.
5. ➤ Use *[UP]* or *[DOWN]* to select the desired running speed; display shows 'SP01...SP15'.
6. ➤ Confirm the selection with *[SETUP]*.  
⇒ The selected setting is accepted.

### Fade effect

Use 'FAde' to select five fade effects and set a running speed.

1. ➤ Press *[MODE]* and use *[UP]* or *[DOWN]* to select the submenu 'FAde'.
2. ➤ Confirm the selection with *[SETUP]*.
3. ➤ Use *[UP]* or *[DOWN]* to select the desired fade effect; display shows 'FA-1...FA-5'.
4. ➤ Confirm the selection with *[SETUP]*.
5. ➤ Use *[UP]* or *[DOWN]* to select the desired running speed; display shows 'SP01...SP15'.



6. ➤ Confirm the selection with *[SETUP]*.  
⇒ The selected setting is accepted.

## Sound control

Use 'SoUn' to select 11 sound control programmes.

1. ➤ Press *[MODE]* and use *[UP]* or *[DOWN]* to select the submenu 'SoUn'.
2. ➤ Confirm the selection with *[SETUP]*.
3. ➤ Use *[UP]* or *[DOWN]* to select the desired sound control programme; display shows 'So00...So10'.
4. ➤ Confirm the selection with *[SETUP]*.  
⇒ The selected setting is accepted.

## Strobe speed

Use 'FLSH' to select 15 strobe speeds.

1. ➤ Press *[MODE]* and use *[UP]* or *[DOWN]* to select the submenu 'FLSH'.
2. ➤ Confirm the selection with *[SETUP]*.
3. ➤ Use *[UP]* or *[DOWN]* to select the desired strobe speed; display shows 'FL01...FL15'.

4. ➤ Confirm the selection with *[SETUP]*.  
⇒ The selected setting is accepted.

### Master / slave mode

Use 'SLAV' to activate or deactivate the Slave mode.

1. ➤ Press *[MODE]* and use *[UP]* or *[DOWN]* to select the submenu 'SLAV'.
2. ➤ Confirm the selection with *[SETUP]*.
3. ➤ Use *[UP]* or *[DOWN]* to select the desired option; display shows 'SL-N' (on) or 'SL-U' (off).
4. ➤ Confirm the selection with *[ENTER]*.  
⇒ The device now operates in slave mode and applies all settings of the master device or works in stand-alone mode again.

### Battery charge display (only item no. 472655)

With 'bAtt' you can check the charge status of the battery.

1. ➤ Press *[MODE]* and use *[UP]* or *[DOWN]* to select the submenu 'bAtt'.
2. ➤ Confirm the selection with *[SETUP]*.  
⇒ The current charge status of the battery is displayed.

## Remote control

With 'Ir' you can activate or deactivate the infrared remote control.

- 1.** ▶ Press *[MODE]* and use *[UP]* or *[DOWN]* to select the submenu 'Ir'.
- 2.** ▶ Confirm the selection with *[SETUP]*.
- 3.** ▶ Use *[UP]* or *[DOWN]* the desired option; display shows 'on' or 'oFF'.
- 4.** ▶ Confirm the selection with *[SETUP]*.  
⇒ Infrared remote control is activated or deactivated.

## 7.3 Menu overview

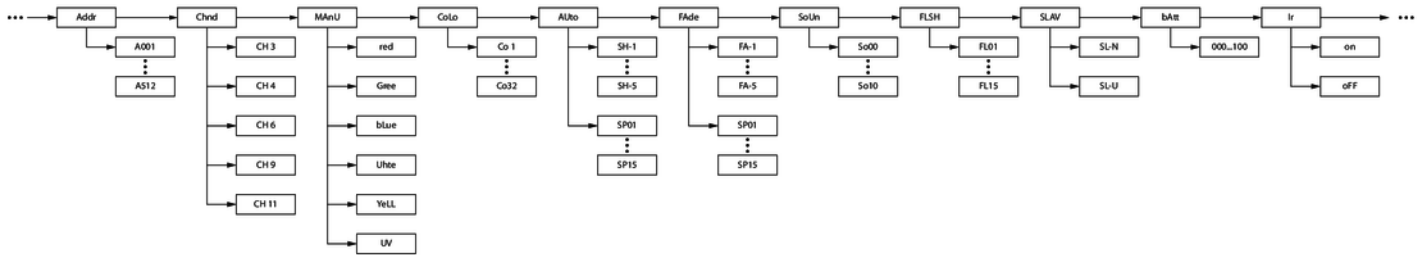

## 7.4 Functions in 3-channel DMX mode

Channel	Value	Function
1	0...255	Intensity red (0 % to 100 %)
2	0...255	Intensity green (0 % to 100 %)
3	0...255	Intensity blue (0 % to 100 %)

## 7.5 Functions in 4-channel DMX mode

Channel	Value	Function
1	0...255	Intensity red (0 % to 100 %)
2	0...255	Intensity green (0 % to 100 %)
3	0...255	Intensity blue (0 % to 100 %)
4	0...255	Intensity white (0 % to 100 %)

## 7.6 Functions in 6-channel DMX mode

Channel	Value	Function
1	0...255	Intensity red (0 % to 100 %)
2	0...255	Intensity green (0 % to 100 %)
3	0...255	Intensity blue (0 % to 100 %)
4	0...255	Intensity white (0 % to 100 %)
5	0...255	Intensity amber (0 % to 100 %)
6	0...255	Intensity UV (0 % to 100 %)

## 7.7 Functions in 9-channel DMX mode

Channel	Value	Function
1	0...255	Intensity red (0 % to 100 %)
2	0...255	Intensity green (0 % to 100 %)
3	0...255	Intensity blue (0 % to 100 %)
4	0...255	Intensity white (0 % to 100 %)
5	0...255	Intensity amber (0 % to 100 %)
6	0...255	Intensity UV (0 % to 100 %)
7	0...255	Intensity master
8	0...255	Strobe master
9	0...10	No function
	11...100	Fade effect, increasing speed

Channel	Value	Function
	101...200	Colour change, increasing speed
	201...255	Sound control

## 7.8 Functions in 11-channel DMX mode

Channel	Value	Function
1	0...255	Intensity red (0 % to 100 %)
2	0...255	Intensity green (0 % to 100 %)
3	0...255	Intensity blue (0 % to 100 %)
4	0...255	Intensity white (0 % to 100 %)
5	0...255	Intensity amber (0 % to 100 %)
6	0...255	Intensity UV (0 % to 100 %)



Channel	Value	Function
7	0...255	Intensity master
8	0...255	Strobe master
9	0...10	No function
	11...100	Fade effect
	101...200	Colour change
	201...255	Sound control
10	0...255	Speed or sensitivity, if channel 9 = 11...200
11	0...14	No function
	15...255	Colour macros

## 8 Technical specifications

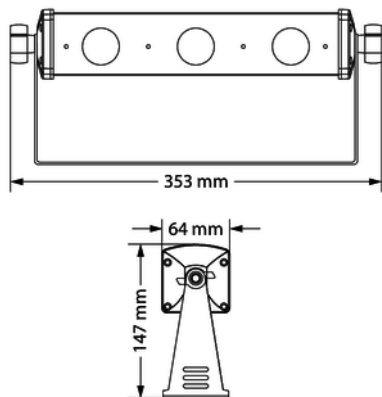

Light source	3 × RGBAWUV LED, each 12 W	
Optical properties	Beam angle	25°
Control	DMX	
	Infrared remote control	
	Buttons and display on the unit	
Control protocol	DMX 512	
Number of DMX channels	3, 4, 6, 9, 11	
Input connections	Voltage supply	Item no. 472654: IEC chassis plug C14 Item no. 472655: Connection socket for power adapter
	DMX control	XLR chassis socket, 3-pin
Output connections	DMX control	XLR chassis socket, 3-pin

Power consumption	36 W	
Voltage supply	100 – 240 V ~ 50/60 Hz	
Fuse (item no. 472654)	5 mm × 20 mm, 1 A, 250 V, slow-blow	
Operating supply voltage	Item no. 472655: Mains adapter (12.6 V $\overline{\text{=}}$ , 1,5 A, centre positive)	
Battery / rechargeable battery (Item no. 472655)	Battery type	Lithium-ion
	Charging time	approx. 4.5 h
Battery remote control	Battery type	2 × button cells, LR1130/AG10, 1.5 V
Protection class	IP20	
Mounting options	standing, hanging	
Dimensions (W × H × D)	360 mm × 150 mm × 64 mm	
Weight	Item no. 472654: 1.2 kg	
	Item no. 472655: 1.45 kg	

Ambient conditions	Temperature range	0 °C...40 °C
	Relative humidity	50 %, non-condensing

**Further information**

Construction	LED bar
Outdoor capable	No
Number of LEDs	3
Colour mixture	RGBAWUV
LED type	x-in-1
LEDs individually controllable	No
Fanless	Yes
Remote control	included
Wireless DMX	No
Housing colour	black

## 9 Plug and connection assignments

### Introduction

This chapter will help you select the right cables and plugs to connect your valuable equipment so that a perfect light experience is guaranteed.

Please take our tips, because especially in 'Sound & Light' caution is indicated: Even if a plug fits into a socket, the result of an incorrect connection may be a destroyed DMX controller, a short circuit or 'just' a not working light show!

### DMX connections

The unit offers a 3-pin XLR socket for DMX output and a 3-pin XLR plug for DMX input. Please refer to the drawing and table below for the pin assignment of a suitable XLR plug.



Pin	Configuration
1	Ground, shielding
2	Signal inverted (DMX-, 'cold signal')
3	Signal (DMX+, 'hot signal')

## 10 Troubleshooting

In the following we list a few common problems that may occur during operation. We give you some suggestions for easy troubleshooting:

Symptom	Remedy
The unit does not work, no light	Check the mains connection.
	For item no. 472655 check the charge status of the battery.
Apparently no function despite proper power supply	Check if the unit is in DMX mode or in 'slave' mode. If so, check the unit in another mode.
No response to the DMX controller	1. Check whether the DMX controller is switched on. Check the DMX connectors and cables for proper connection.
	2. Check the address settings and the DMX polarity.
	3. Try using another DMX controller.
	4. Check whether the DMX cables run near or parallel to high-voltage cables that may cause damage or interference to a DMX interface circuit.

If the procedures recommended above do not succeed, please contact our Service Center. You can find the contact information at [www.thomann.de](http://www.thomann.de).



# 11 Cleaning

## Optical lenses

Clean the optical lenses, that are accessible from the outside, regularly in order to optimize the light output. The frequency of cleaning depends on the operating environment: wet, smoky or particularly dirty surroundings can cause more accumulation of dirt on the optics of the device.

- Clean with a soft cloth using our lamp and lens cleaner (item no. 280122).
- Always dry the parts carefully.

## Fan grids

The fan grids of the device must be cleaned of any contamination, such as dust, etc. on a regular basis. Before cleaning, switch off the device and disconnect mains-operated devices from the mains. Only use pH-neutral, solvent-free and non-abrasive cleaning agents. Clean the unit with a slightly damp lint-free cloth.

## 12 Protecting the environment

### Disposal of the packaging material



For the packaging, environmentally friendly materials have been chosen that can be supplied to normal recycling.

Ensure that plastic bags, packaging, etc. are properly disposed of.

Do not just dispose of these materials with your normal household waste, but make sure that they are collected for recycling. Please follow the notes and markings on the packaging.

### Disposal of batteries



Batteries do contain some hazardous chemicals so they should not be thrown away with the normal household waste. They should be returned to the manufacturer for disposal or recycled elsewhere in accordance with your local regulations.

Remove lithium batteries from the device before disposal. Protect used lithium batteries against potential short circuits, e.g. by covering the poles with adhesive tape. Dispose the built-in lithium batteries together with the device. Please check for an appropriate reception facility.

### Disposal of your old device



This product is subject to the European Waste Electrical and Electronic Equipment Directive (WEEE) in its currently valid version. Do not dispose with your normal household waste.

Dispose of this device through an approved waste disposal firm or through your local waste facility. When discarding the device, comply with the rules and regulations that apply in your country. If in doubt, consult your local waste disposal facility.









