

AV STREAMING MIXER VR-1HD

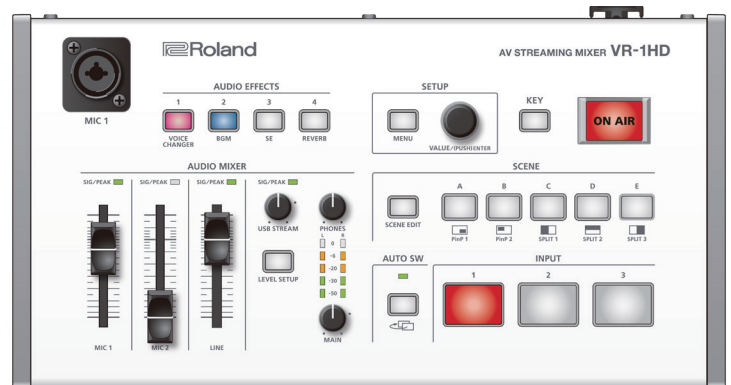

Contents

Panel Description	2	Live Streaming	25
Top Panel	2	Outputting Video/Audio to a Computer for Streaming.....	25
Rear Panel/Side Panel (Connecting Your Equipment)	4	Other Features	26
Basic Operations	6	Saving Internal Settings to a USB Flash Drive	26
Turning the Power On/Off	6	Formatting a USB Flash Drive.....	27
Operating the Menu	6	Disabling Panel Operations (Panel Lock)	27
Video Input/Output Settings	7	Returning to the Factory Settings (Factory Reset)	28
List of Compatible Video Formats	7	Menu List	29
Setting the Output Format.....	7	VIDEO INPUT Menu	29
Specifying the Input Format (EDID)	8	VIDEO OUTPUT Menu	30
Adjusting Output Video	8	SCENE Menu	31
Adjusting Input Video	9	TRANSITION Menu.....	32
Inputting Copy-Protected (HDCP) Video	9	KEY Menu.....	32
Video Operations	10	AUTO SWITCHING Menu.....	32
Using Buttons to Switch the Video	10	ON AIR Menu.....	33
Switching the Video Automatically (Auto Switching)	10	AUDIO INPUT Menu.....	33
Displaying a Combination of Two Videos (Scene)	12	AUDIO OUTPUT Menu.....	36
Compositing a Logo or Image (Luminance Key).....	14	AUDIO FOLLOWS VIDEO Menu	37
Fading-In/Out the Main Output Video	14	AUTO MIXING Menu	37
Outputting a Loaded Still Image.....	15	ECHO CANCELLER Menu.....	37
Audio Operations	16	AUDIO EFFECTS Menu.....	38
Adjusting the Mic's Input Gain (Sensitivity).....	16	USB MEMORY Menu	40
Adjusting the Volume Balance.....	16	SYSTEM Menu.....	41
Reducing Acoustic Feedback (Howling Canceller).....	17	LEVEL SETUP Menu	42
Changing the Character of a Voice (Voice Changer)	17	Appendices	43
Applying Effects to Input Audio	18	Troubleshooting.....	43
Using an Effect Preset	19	Block Diagram.....	44
Applying Effects to Output Audio.....	20	Main Specifications	46
Correcting a Time Difference Between Video and Audio (Delay) ..	20	Dimensions	47
Silencing Only Specific Audio (Mute)	21	Shortcut List	48
Checking a Specific Audio Input (Solo)	21		
Interlinking Audio Output to Video Switching (Audio Follow)	22		
Controlling the Volume Automatically (Auto Mixing)	22		
Playing Back Music Files	23		
Suppressing Echo in a Web Conference System (Echo Canceller).....	24		
About the AUX Bus	24		

Panel Description

Top Panel

MIC 1 jack

Connect your mic here. If you connect a condenser mic that requires a phantom power supply, turn the side panel [PHANTOM] switch on.

NOTE

- If you use a gooseneck mic, operating noise might be picked up.
- Do not connect a mic that supports plug-in power, or the mics that are included with Roland "VP-03" or "JD-Xi." Doing so will cause malfunctions

* Pin assignment of MIC 1 and MIC 2 jacks

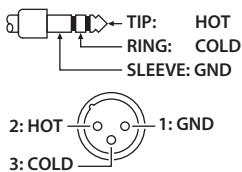

AUDIO EFFECTS [1]–[4] buttons (p. 17, 19, 23)

Turn the audio effects on/off. When on, the button is lit.

Button	Effect
[1] (VOICE CHANGER)	Transforms the pitch or character of the voice.
[2] (BGM)	Plays background music.
[3] (SE)	Plays a sound effect.
[4] (REVERB)	Adds reverberation to the sound.

* The above are the factory settings. You can also assign other functions to each of buttons.

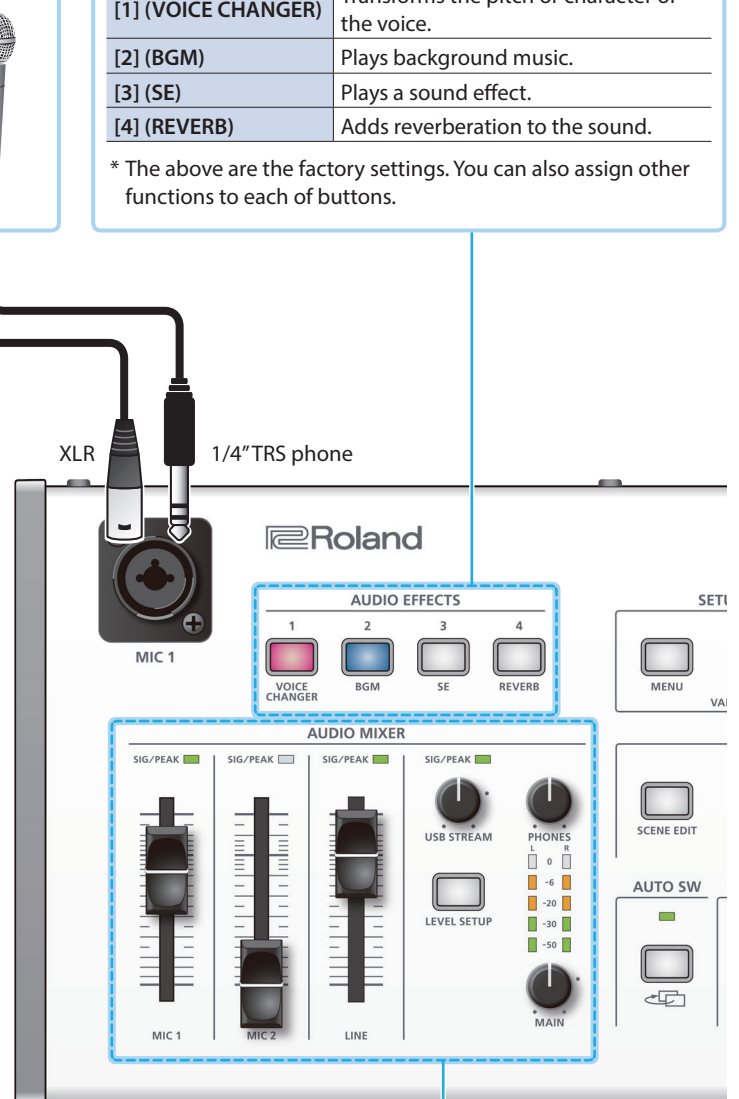

AUDIO MIXER area (p. 16)

SIG/PEAK indicators (MIC 1/MIC 2/LINE)

These are lit green when audio input is detected. If the input is excessive, the indicator is lit red.

[MIC 1][MIC 2][LINE] faders

Adjust the volume of the MIC 1, MIC 2, and LINE inputs.

SIG/PEAK indicator (USB STREAM)

Indicates the volume level of the USB output.

[USB STREAM] knob

Adjusts the volume of the USB output.

[LEVEL SETUP] button

Accesses the menu of settings related to volume, input gain, solo, and mute.

[PHONES] knob

Adjusts the volume of the headphones.

Level meter

Indicates the volume level of the main output.

[MAIN] knob

Adjusts the volume of the main output.

SETUP area (p. 6)

[MENU] button

When this is on (lit), the menu appears on the display that's connected to the MONITOR (MENU) connector.
If you're in a lower level, this button returns to the next higher level. If the highest menu level is shown, this button closes the menu.

[VALUE] knob

Turn: Selects a menu item, or edits the value of a setting.
Press: Confirms the selected menu item or the edited value.

[KEY] button (p. 14)

Turns on/off video compositing using a luminance key. When on (lit), two videos are composited and output.

What is luminance key compositing?

This is a method of using brightness (luminance) information to cut out a logo or image and overlay it on a background image.



[ON AIR] button (p. 14)

Fades-in/out the main output video.
The [ON AIR] button indicates the fade status.

Lit	Normal output
Blinking	Now fading-in/out
Unlit	Faded out

* The fade-in/out effect does not apply to the video that's output from the MONITOR (MENU) connector.

SCENE area (p. 12)

[SCENE EDIT] button

Directly accesses the scene-related menu.

SCENE [A]–[E] buttons

Recall screen arrangements (scenes) that you've registered. The selected button is lit red.

* When you select the INPUT [1]–[3] buttons, the scene selection is cleared.

INPUT [1]–[3] buttons (p. 10)

Switch the video that's being input to the VIDEO INPUT 1–3 connectors. The selected button is lit red.

* When you select the SCENE [A]–[E] buttons, the input video selection is canceled.

* Still images saved in this unit or single-color screens can also be assigned to the INPUT [1]–[3] buttons.

What is the main output?

This is the video/audio output that is affected by all processes such as video compositing and audio effects. It is output from the MAIN connector.

This is the video that is seen by the people who are watching the live stream or presentation.

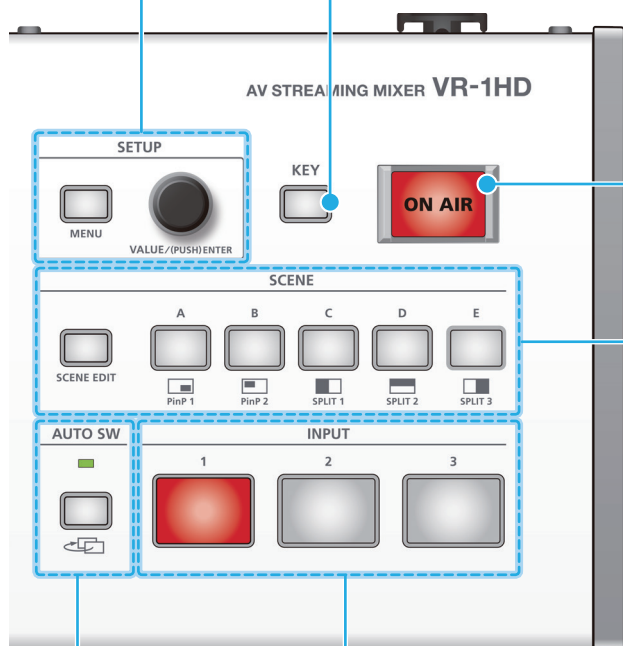

AUTO SW area (p. 10)

[AUTO SW] button

Turn the auto switching function on/off. If this is on (lit), the INPUT 1–3 video and scenes A–E will switch automatically.

* Auto switching has three operating modes.

AUTO SW indicator

Lit green at the moment that auto switching switches the video.

* Operates at all times, regardless of whether auto switching is on or off.

Rear Panel/Side Panel (Connecting Your Equipment)

* To prevent malfunction and equipment failure, always turn down the volume, and turn off all the units before making any connections.

MAIN connector

This outputs the result of mixing the video (main video) and audio. Connect it to your projector, display, or video recorder for recording.



MONITOR (MENU) connector

Connect this to your display to view the menu. This connector also outputs the main video before the fade-out effect is applied.



Ground terminal

Connect this to an external earth or ground if necessary.

DC IN jack

Connect the included AC adaptor to this jack.

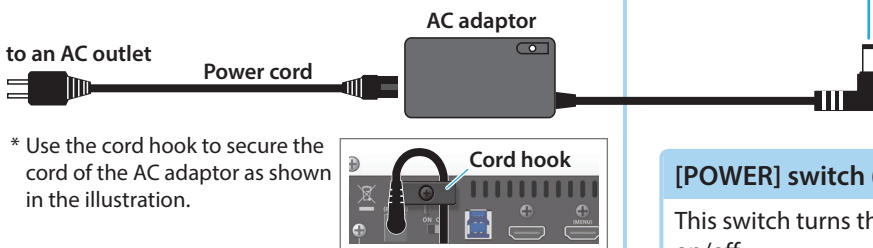

* Use the cord hook to secure the cord of the AC adaptor as shown in the illustration.

[POWER] switch (p. 6)

This switch turns the power on/off.

USB STREAM port (p. 25)



Connect this to your computer. The result of the VR-1HD's video/audio mix is output from here to your computer. You can use this to live-stream your video/audio.

This also inputs the audio playback from your computer into the VR-1HD.

* If you are outputting HD video via USB, connect this to a USB 3.0 port of your computer.

* If you connect via an extension cable or a USB hub, the computer might not recognize the VR-1HD. We recommend that you connect the VR-1HD directly to your computer.

THRU connector



This "thru-outputs" the video that's being input from the VIDEO INPUT 3 connector. Connect this to your display or to a video recording for recording.

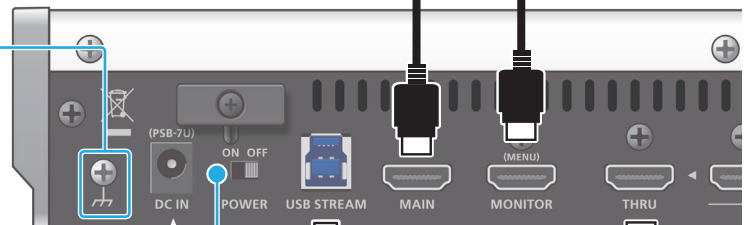

* Do not block the ventilation openings (the slits located on the front and side panels, etc.). If the ventilation openings are blocked, the internal temperatures may rise, causing malfunctions due to excessive heat.

VIDEO INPUT 1-3 connectors

These input video/audio. Connect them to video devices such as a video camera or BD player, or to your computer.

* The input format is detected automatically.

HDMI output connector

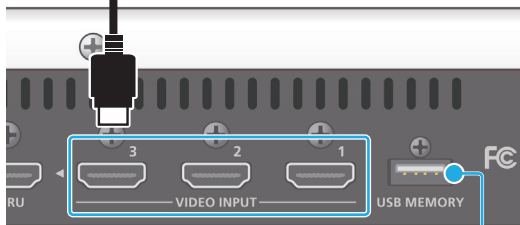

USB MEMORY port (p. 15, 23)

Connect a USB flash drive here. You can use it when loading a music file (background music or sound effects) or a still image.



[PHANTOM] switch

Turns on/off the phantom power of the MIC 1 and MIC 2 jacks (XLR). Turn on the phantom power supply if you connect a condenser mic that requires a phantom power supply.

* If you don't need phantom power, be sure to turn off the [PHANTOM] switch.

* Phantom power is common to the MIC 1 and MIC 2 jacks.

MIC 2 jack

Connect your mic here. If you connect a condenser mic that requires a phantom power supply, turn the [PHANTOM] switch on.

NOTE

- If you use a gooseneck mic, operating noise might be picked up.
- Do not connect a mic that supports plug-in power, or the mics that are included with Roland "VP-03" or "JD-Xi." Doing so will cause malfunctions.

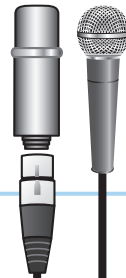

PHONES jack

Connect headphones here.

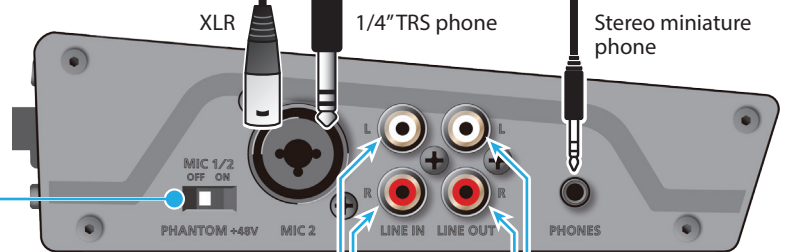

RCA phono

RCA phono

LINE IN jacks



Audio output connectors

These input audio. Connect them to an audio device such as an audio mixer or CD player.

LINE OUT jacks

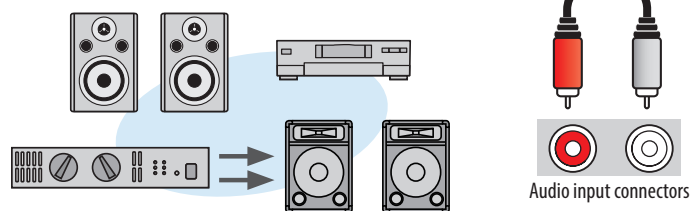

Audio input connectors

These output the result of audio mixing. Connect them to your audio recorder, amp, or speakers.

Basic Operations

Turning the Power On/Off

* Before turning the unit on/off, always be sure to turn the volume down. Even with the volume turned down, you might hear some sound when switching the unit on/off. However, this is normal and does not indicate a malfunction.

Turning the power on

MEMO

If a USB flash drive containing the still images (p. 15) that were last loaded is connected when the VR-1HD starts, the still images are loaded automatically. In this case, startup might take some time depending on the size and number of the still images that are loaded.

1. Make sure that all devices are powered-off.
2. Turn on the VR-1HD's [POWER] switch.

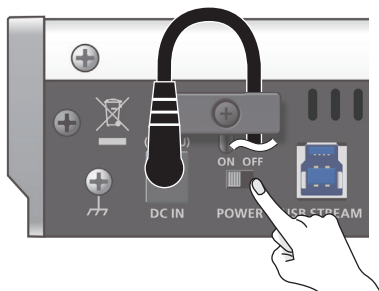

3. Turn on the power in the order of source devices → output devices.

Turning the power off

1. Turn off the power in the order of output devices → source devices.
2. Turn off the VR-1HD's [POWER] switch.

About the Auto Off function

The power to the VR-1HD turns off automatically when all of the following states persist for 240 minutes (Auto Off function).

- No operation performed on the VR-1HD
- No audio or video input
- No equipment is connected to the MAIN/MONITOR (MENU)

If you do not want the power to be turned off automatically, disengage the Auto Off function. Press the [MENU] button → "SYSTEM" → set "AUTO POWER OFF" to "OFF."

* If the auto-off function has turned off the power, slide the [POWER] switch when you want to turn the power on again.

Operating the Menu

Here's how to access the menu, and make video/audio settings and settings for this unit. The menu is shown on the display that's connected to the MONITOR (MENU) connector.

1. Press the [MENU] button to display the MENU screen.

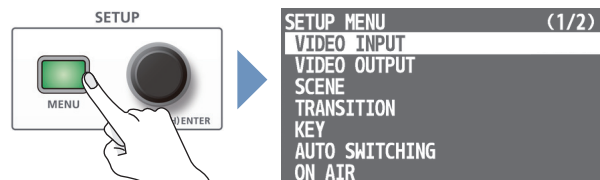

The menu is organized into functions.

2. Turn the [VALUE] knob to select the menu item that you want to edit, and press to confirm.

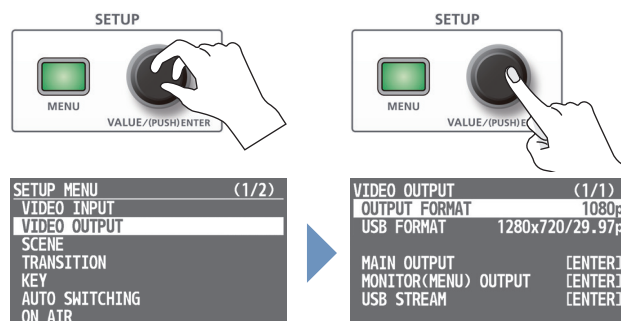

3. Repeat step 2 as needed.
Pressing the [MENU] button moves you back one level higher.
4. Turn the [VALUE] knob to edit the value of the setting, and press to confirm.
 - By turning the [VALUE] knob while pressing it, you can change the value more greatly.
 - Long-pressing the [VALUE] knob returns the current menu item you're setting to its default value.
5. Press the [MENU] button several times to close the menu.

MEMO

- The contents of the menu settings are saved to the unit every four seconds or when you close the menu.
- When you press the [LEVEL SETUP] button, the menu for volume, input gain, solo, and mute settings appears (p. 42).
- There are shortcuts that let you quickly access the menu for specific buttons and knobs.
For details, refer to "Shortcut List" (p. 48).
- **If you want to temporarily change where the menu is shown**
If you start up the VR-1HD with the following operation, the menu is shown on the display connected to the MAIN connector and on the USB STREAM output.
While holding down the [MENU] button and the [VALUE] knob, turn on the power. When the unit becomes operable, release the button and knob.
 - * The menu will no longer be shown on the display connected to the MONITOR (MENU) connector.
 - * Operations of the [ON AIR] button (p. 14) will affect only the output of the MONITOR (MENU) connector.

Video Input/Output Settings

List of Compatible Video Formats

Input video formats

Frame rate	
When set to "59.94 Hz"	When set to "50 Hz"
480/59.94i	576/50i
480/59.94p	576/50p
720/59.94p	720/50p
1080/59.94i	1080/50i
1080/59.94p	1080/50p
VGA (640 x 480/60 Hz)	VGA (640 x 480/60 Hz)
SVGA (800 x 600/60 Hz)	SVGA (800 x 600/60 Hz)
XGA (1024 x 768/60 Hz)	XGA (1024 x 768/60 Hz)
WXGA (1280 x 800/60 Hz)	WXGA (1280 x 800/60 Hz)
HD (1280 x 720/60 Hz)	HD (1280 x 720/60 Hz)
SXGA (1280 x 1024/60 Hz)	SXGA (1280 x 1024/60 Hz)
FWXGA (1366 x 768/60 Hz)	FWXGA (1366 x 768/60 Hz)
SXGA+ (1400 x 1050/60 Hz)	SXGA+ (1400 x 1050/60 Hz)
UXGA (1600 x 1200/60 Hz)	UXGA (1600 x 1200/60 Hz)
FHD (1920 x 1080/60 Hz)	FHD (1920 x 1080/60 Hz)
WUXGA (1920 x 1200/60 Hz)	WUXGA (1920 x 1200/60 Hz)

Audio input format

INPUT 1–3 connectors	Linear PCM, 24 bits, 48 kHz, stereo
USB STREAM port	Linear PCM, 16 bits, 48 kHz, stereo

Output video formats

MAIN/MONITOR (MENU) connectors

Frame rate	
When set to "59.94 Hz"	When set to "50 Hz"
720/59.94p	720/50p
1080/59.94i	1080/50i
1080/59.94p	1080/50p
XGA (1024 x 768/60 Hz)	XGA (1024 x 768/75 Hz)
WXGA (1280 x 800/60 Hz)	WXGA (1280 x 800/75 Hz)
SXGA (1280 x 1024/60 Hz)	SXGA (1280 x 1024/75 Hz)
FWXGA (1366 x 768/60 Hz)	FWXGA (1366 x 768/75 Hz)
SXGA+ (1400 x 1050/60 Hz)	SXGA+ (1400 x 1050/75 Hz)
UXGA (1600 x 1200/60 Hz)	UXGA (1600 x 1200/60 Hz)
FHD (1920 x 1080/60 Hz)	FHD (1920 x 1080/60 Hz)
WUXGA (1920 x 1200/60 Hz)	WUXGA (1920 x 1200/60 Hz)

USB STREAM port

Frame rate	
When set to "59.94 Hz"	When set to "50 Hz"
854 x 480/29.97p	854 x 480/25p
854 x 480/59.94p	854 x 480/50p
1280 x 720/29.97p	1280 x 720/25p
1280 x 720/59.94p	1280 x 720/50p
1920 x 1080/29.97p	1920 x 1080/25p

Audio input format

MAIN connector	Linear PCM, 24 bits, 48 kHz, stereo
MONITOR (MENU) connector	Linear PCM, 24 bits, 48 kHz, stereo
USB STREAM port	Linear PCM, 16 bits, 48 kHz, stereo

Setting the Output Format

Here's how to specify the output format as appropriate for the device that's connected.

MAIN/MONITOR (MENU) connectors

1. [MENU] button → "VIDEO OUTPUT" → select "OUTPUT FORMAT."

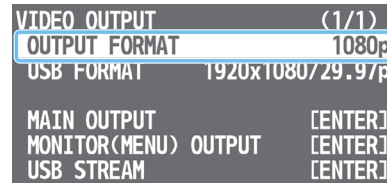

2. Turn the [VALUE] knob to select the output format, and press to confirm.

The output format switches, and a confirmation message appears.



If you want to cancel the operation, press the [MENU] button.

* If the changed format is not compatible with the output destination device, a confirmation message does not appear. In approximately 20 seconds the setting returns to its previous state.

3. Turn the [VALUE] knob to select "YES," and press to confirm.

The message "COMPLETED" appears.

* If you don't confirm within ten seconds, the change is not applied, and the setting returns to its previous state.

4. Press the [VALUE] knob to close the message.

5. Press the [MENU] button several times to close the menu.

USB STREAM port

Here's how the video converted to the specified "OUTPUT FORMAT" can be further converted into a format that can be streamed.

1. [MENU] button → "VIDEO OUTPUT" → select "USB FORMAT."

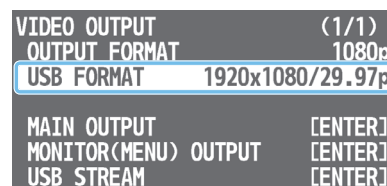

2. Turn the [VALUE] knob to select the output format, and press to confirm.

The output format switches.

3. Press the [MENU] button several times to close the menu.

About frame rate

The VR-1HD supports the frame rates "59.94 Hz" and "50 Hz." To specify the frame rate, use the [MENU] button → "SYSTEM" → "FRAME RATE."

The USB output also supports the frame rates "29.97 Hz" and "25 Hz." When you specify the output format of the USB STREAM port, you select a combination of resolution and frame rate.

Specifying the Input Format (EDID)

With the factory settings, EDID is set to "DEFAULT" (the unit transmits EDID information for all formats that it is able to input).

Change this setting if you want EDID information for a specific input format to be sent to a source device.

What is EDID?

EDID is data that is transmitted from the VR-1HD to the source device when the VR-1HD is connected to a source device. EDID contains data such as the formats that can be input to the VR-1HD (resolution, color space, color depth) and audio information.

Based on the EDID information that the source device receives, it will output the most appropriate video format to the VR-1HD.

1. [MENU] button → "VIDEO INPUT" → "INPUT 1"-"INPUT 3" → select "EDID."

VIDEO INPUT 1	(1/2)
STATUS	1024x768
INPUT SOURCE	HDMI
EDID	DEFAULT
ZOOM	100.0%
SCALING TYPE	FULL
MANUAL SIZE H	0
MANUAL SIZE V	0
POSITION H	0
POSITION V	0

2. Turn the [VALUE] knob to select the input format (EDID), and press to confirm.
The input format (EDID) switches.
3. Press the [MENU] button several times to close the menu.

Adjusting Output Video

Here's how to adjust the output image appropriately for the device that's receiving the VR-1HD's output.

1. [MENU] button → "VIDEO OUTPUT" → select "MAIN OUTPUT," "MONITOR (MENU) OUTPUT," or "USB STREAM."

VIDEO OUTPUT	(1/1)
OUTPUT FORMAT	1080p
USB FORMAT	1920x1080/29.97p
MAIN OUTPUT	[ENTER]
MONITOR (MENU) OUTPUT	[ENTER]
USB STREAM	[ENTER]

A detailed menu appears.

2. Use the [VALUE] knob to select a menu item.

● MAIN OUTPUT, MONITOR (MENU) OUTPUT

Menu item	Explanation
COLOR SPACE	Specifies the color space (system for representing colors in video).
DVI-D/HDMI	Specifies the type of output signal.
ZOOM (*1)	Adjusts the zoom ratio.
POSITION H (*1)	Adjusts the display position in the horizontal direction.
POSITION V (*1)	Adjusts the display position in the vertical direction.
BRIGHTNESS	Adjusts the brightness.
CONTRAST	Adjusts the contrast.
SATURATION	Adjusts the saturation.
RED	Adjusts the red level.
GREEN	Adjusts the green level.
BLUE	Adjusts the blue level.

(*1) MAIN OUTPUT only

● USB STREAM

Menu item	Explanation
ZOOM	Adjusts the zoom ratio.
SCALING TYPE	Specifies the scaling type.
MANUAL SIZE H	Adjusts the horizontal size.
MANUAL SIZE V	Adjusts the vertical size.
POSITION H	Adjusts the display position in the horizontal direction.
POSITION V	Adjusts the display position in the vertical direction.
CONNECTION RESET	Reconnects the computer and the VR-1HD when the video is garbled or when operation is otherwise unstable.

2. Turn the [VALUE] knob to edit the value of the setting, and press to confirm.
3. Press the [MENU] button several times to close the menu.

MEMO

You can output a test pattern, useful for adjusting the image quality of a display. Use the [MENU] button → "SYSTEM" → "TEST PATTERN" to select the type of test pattern.

Adjusting Input Video

Here's how to adjust the quality and scaling of the video signals that are assigned to the INPUT [1]–[3] buttons.

1. [MENU] button → "VIDEO INPUT" → select "INPUT 1"–"INPUT 3."



A detailed menu appears.

2. Use the [VALUE] knob to select a menu item.

Menu item	Explanation
ZOOM	Adjusts the zoom ratio.
SCALING TYPE	Specifies the scaling type.
MANUAL SIZE H	Adjusts the horizontal size.
MANUAL SIZE V	Adjusts the vertical size.
POSITION H	Adjusts the display position in the horizontal direction.
POSITION V	Adjusts the display position in the vertical direction.
BRIGHTNESS	Adjusts the brightness.
CONTRAST	Adjusts the contrast.
SATURATION	Adjusts the saturation.
RED	Adjusts the red level.
GREEN	Adjusts the green level.
BLUE	Adjusts the blue level.
COLOR SPACE	Specifies the color space (system for representing colors in video). If this is set to "AUTO," an appropriate color space is automatically applied.
FLICKER FILTER	If this is "ON," flickering is reduced.

3. Turn the [VALUE] knob to edit the value of the setting, and press to confirm.
4. Press the [MENU] button several times to close the menu.

MEMO

In addition to the video signals that are being input from the VIDEO INPUT connectors, you can also assign still images or single-color screens to the INPUT [1]–[3] buttons.

To make these settings, use the [MENU] button → "VIDEO INPUT" → "INPUT 1"–"INPUT 3" → "INPUT SOURCE."

Value	Explanation
HDMI	The video being input from the VIDEO INPUT connector
STILL IMAGE 1, 2	A still image loaded into the unit (p. 15)
BLACK, WHITE, GRAY, GREEN, BLUE	Single-color screen

* A still image loaded into the unit cannot be made smaller. If resizing would make the still image smaller than its original size, it will not be resized (smaller), but instead a portion of the still image will be cut out for display.

Inputting Copy-Protected (HDCP) Video

If you want to input HDCP-protected video from a BD player or other device, you can enable HDCP input.

* If you want to output HDCP-protected video, connect an HDCP-capable display.

What's HDCP?

HDCP is copyright-protection technology that prevents unlawful copying of content by encoding the path when sending digital signals from a video playback device to a display monitor or other display equipment.

1. [MENU] button → "SYSTEM" → select "HDCP."

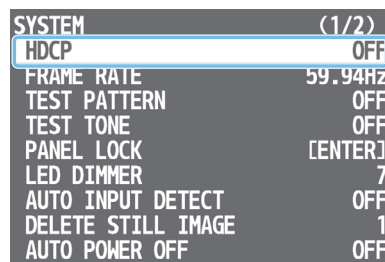

2. Turn the [VALUE] knob to select "ON," and press to confirm.

Value	Explanation
ON	HDCP-protected video can be input. HDCP is also added to the video that is output.
OFF	HDCP-protected video cannot be input.

3. Press the [MENU] button several times to close the menu.

NOTE

If "HDCP" is "ON," video and audio are not output from the USB STREAM port.

Video Operations

Using Buttons to Switch the Video

Here's how to manually switch between the INPUT 1–3 video signals.

1. Press an INPUT [1]–[3] button to select the video.

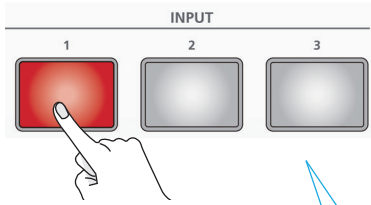

Button	Video status
Lit red	Currently selected input video (the video being output).
Blinking red	Currently switching video.
Lit white	Valid video is input.
Unlit	No video is input.

The selected button blinks red, and the video is gradually switched. When the video has switched completely, the button changes from blinking red to lit red.

* When you select scene (p. 12), the input video selection is canceled.

MEMO

• Video transition time

You can set the video transition time by using [MENU] button → "TRANSITION" → "TIME." This setting is common to the scene (p. 12) transition time.

• Transition effects

A mix effect is applied when you switch between videos. The two videos are mixed during the transition.



In the sampling cases, the transition occurs as a cut (instantaneous switch).

- If the transition time is set to "0.0sec."
- If you press an INPUT/SCENE button while a transition is occurring

• Video source

In addition to the video signals that are being input from the VIDEO INPUT connectors, you can also assign still images or single-color screens to the INPUT [1]–[3] buttons.

To make these settings, use the [MENU] button → "VIDEO INPUT" → "INPUT 1"–"INPUT 3" → "INPUT SOURCE."

Value	Explanation
HDMI	The video being input from the VIDEO INPUT connector
STILL IMAGE 1, 2	A still image loaded into the unit (p. 15)
BLACK, WHITE, GRAY, GREEN, BLUE	Single-color screen

Switching the Video Automatically (Auto Switching)

The video of INPUT 1–3 or of scenes (p. 12) can be switched automatically (the auto switching function). You can make operation easier by letting the video switch automatically.

Operation modes for auto switching

Auto switching provides three operation modes that you can select as appropriate for your situation: "auto scan," "beat sync," and "video follows audio."

● Switching at a specified interval (auto scan)

This automatically switches the video when a specified length of time elapses. You can change the duration that each video is shown, and also switch randomly between videos.

This is convenient when you want to switch between video signals of multiple cameras, for example when live-streaming a singer-instrumentalist.

* INPUT 1–3 are skipped if there is no video input.

● Switching in sync with the beat of the music (beat sync)

This detects the beat of the song, and automatically switches the video at intervals of the beat.

This lets you create video transitions that are synchronized with the music, for example when live-streaming a DJ performance or a musical performance.

* For some songs, it might not be possible to correctly detect the beat.

* INPUT 1–3 are skipped if there is no video input.

● Switching according to the mic volume (video follows audio)

This detects the audio that is input from a mic, and automatically switches to the specified video according to the volume.

For example, if you're streaming a talk show or a conversation, you can use this to switch between a closeup of the individual who is speaking and a wide shot of both people when neither person is speaking.

Specifying the operation mode

● Auto scan

1. [MENU] button → “AUTO SWITCHING” → select “TYPE.”



2. Turn the [VALUE] knob to select “AUTO SCAN,” and press to confirm.

3. Use the [VALUE] knob to select a menu item.

Menu item	Explanation
SEQUENCE	Specifies the order in which video signals are shown. NORMAL: INPUT 1-3 → switch in the order of scenes A-E. RANDOM: Switch randomly.
INPUT 1-3 DURATION	Specifies the time that the video is shown. If this is “OFF,” video switching does not affect the input.
SCENE A-E DURATION	

4. Turn the [VALUE] knob to edit the value of the setting, and press to confirm.
5. Press the [MENU] button several times to close the menu.

● Beat sync

1. [MENU] button → “AUTO SWITCHING” → select “TYPE.”

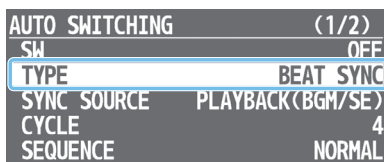

2. Turn the [VALUE] knob to select “BEAT SYNC,” and press to confirm.

3. Use the [VALUE] knob to select a menu item.

Menu item	Explanation
SYNC SOURCE	Specifies the input audio that synchronizes the video.
CYCLE	Specifies the number of beats at which to switch to the next video.
SEQUENCE	Specifies the order in which video signals are shown. NORMAL: INPUT 1-3 → switch in the order of scenes A-E. RANDOM: Switch randomly.
INPUT 1-3 SW	Specifies whether video switching applies (ON) or does not apply (OFF) to the source.
SCENE A-E SW	

4. Turn the [VALUE] knob to edit the value of the setting, and press to confirm.
5. Press the [MENU] button several times to close the menu.

● Video follows audio

1. [MENU] button → “AUTO SWITCHING” → select “TYPE.”

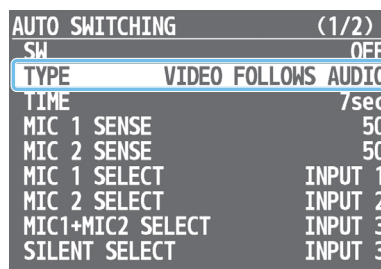

2. Turn the [VALUE] knob to select “VIDEO FOLLOWS AUDIO,” and press to confirm.

3. Use the [VALUE] knob to select a menu item.

Menu item	Explanation
TIME	Specifies the time until audio detection resumes after mic audio has been detected to switch the video or scene.
MIC 1 SENSE	Specify the detection level for the audio being input to the MIC 1 or 2 jack. The higher the level, the more easily audio is detected.
MIC 2 SENSE	
MIC 1 SELECT	Specifies the video/scene that is output when audio is detected in MIC 1.
MIC 2 SELECT	Specifies the video/scene that is output when audio is detected in MIC 2.
MIC 1 + MIC 2 SELECT	Specifies the video/scene that is output when audio is detected in both MIC 1 and MIC 2.
SILENT SELECT	Specifies the video/scene that is output when there is no audio input in either MIC 1 or MIC 2.

4. Turn the [VALUE] knob to edit the value of the setting, and press to confirm.
5. Press the [MENU] button several times to close the menu.

Turning the auto switching function on/off

1. Press the [AUTO SW] button to turn the auto switching function on (lit).

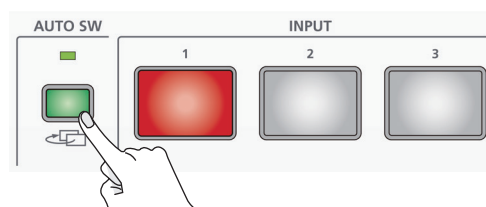

* If you're using beat sync, input or playback a song.

2. To turn the auto switching function off, press the [AUTO SW] button once again.

Displaying a Combination of Two Videos (Scene)

You can register a configuration of screens as a “scene” and show a combination of two videos. If you register your favorite configurations as scenes, you can instantly switch between those configurations just by pressing SCENE buttons. The VR-1HD provides five scenes.

Types of screen configuration

There are two types of screen configuration that can be registered in a scene: “picture-in-picture” overlays an inset screen onto a background video, and “split” divides the screen horizontally or vertically.

● Picture-in-picture (PinP)

This overlays video of an inset screen (a small separate screen) onto the background video.



● Split

This divides the screen into left/right or upper/lower halves, and shows two videos.

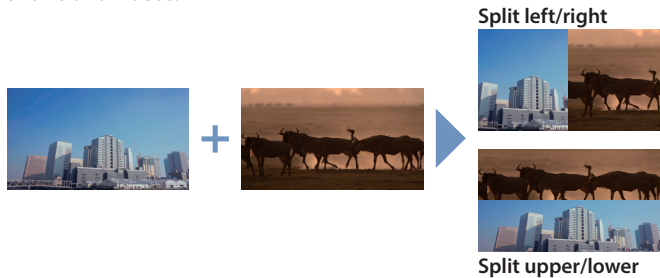

Recalling

With the factory settings, the screen configurations printed on the operating panel are registered in the SCENE [A]–[E] buttons.

1. Press the SCENE button of the screen configuration that you want to recall.

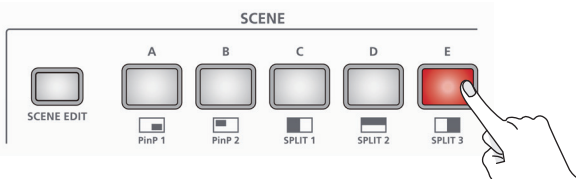

The scene is recalled, and the screen configuration changes. The selected button is lit red.

* When you select INPUT 1–3, the scene selection is cleared.

MEMO

- The scene transition time is shared with the video transition time. The setting of [MENU] button → “TRANSITION” → “TIME” applies.
- You can change the scene transition effect. To make these settings, use the [MENU] button → “TRANSITION” → “SCENE TRANSITION.”

Value	Explanation
BLACK FADE	A fade effect enclosing a black screen is applied. All screens switch simultaneously.
MIX FADE	A fade effect is applied. Screens switch individually.

Registering

● Picture-in-picture (PinP)

1. [SCENE EDIT] button → “SCENE A”–“SCENE E” → select “TYPE.”

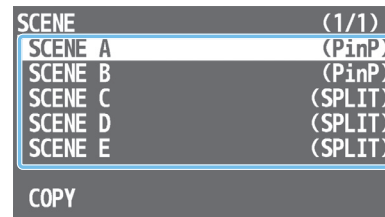

Shows the type of screen configuration that is currently registered.

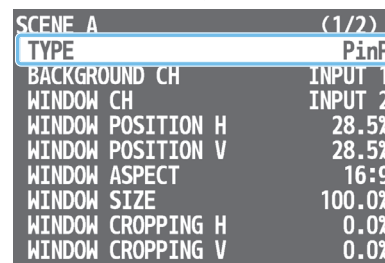

2. Turn the [VALUE] knob to select “PinP” and press to confirm.
3. Use the [VALUE] knob to select a menu item.

Menu item	Explanation
BACKGROUND CH	Specifies the background video.
WINDOW CH	Specifies the inset screen video.
WINDOW POSITION H	Adjusts the horizontal display position of the inset screen.
WINDOW POSITION V	Adjusts the vertical display position of the inset screen.
WINDOW ASPECT	Specifies the aspect ratio of the inset screen.
WINDOW SIZE	Adjusts the size of the inset screen.
WINDOW CROPPING H	Adjusts the horizontal size of the inset screen.
WINDOW CROPPING V	Adjusts the vertical size of the inset screen.
VIEW POSITION H	Adjusts the horizontal position of the video shown in the inset screen.
VIEW POSITION V	Adjusts the vertical position of the video shown in the inset screen.
VIEW ZOOM	Adjusts the zoom of the video shown in the inset screen.

4. Turn the [VALUE] knob to edit the value of the setting, and press to confirm.
5. Press the [SCENE EDIT] button several times to close the menu.

MEMO



A still image loaded into the unit (p. 15) cannot be made smaller. If the still image is shown in the inset screen, a portion of the still image is cut out and shown, instead of making it smaller to match the size of the inset screen.

● Split

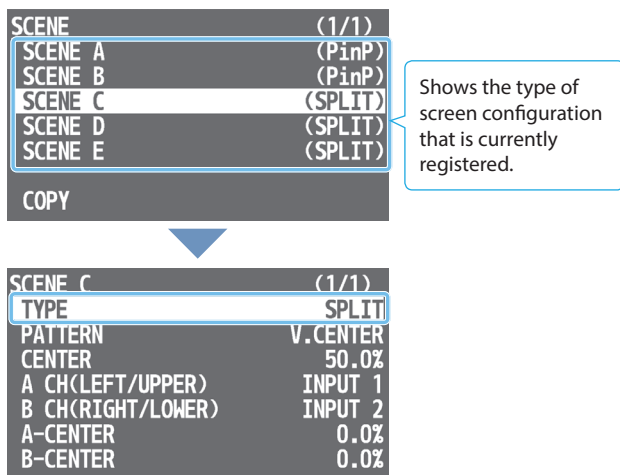
1. [SCENE EDIT] button → “SCENE A”–“SCENE E” → select “TYPE.”

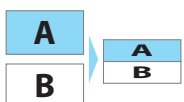

2. Turn the [VALUE] knob to select “SPLIT,” and press to confirm.
3. Use the [VALUE] knob to select a menu item.

Menu item	Explanation	
PATTERN	Specifies the pattern for the split. V.CENTER:  H.CENTER: 	
	V.STRETCH:  H.STRETCH: 	
	CENTER	Adjusts the position at which the screen is divided.
	A CH (LEFT/UPPER)	Specifies the video that is shown in the left or upper side.
B CH (RIGHT/LOWER)	Specifies the video that is shown in the right or lower side.	
A-CENTER (*1)	Adjusts the horizontal/vertical position of the video that's shown in the left or upper area.	
B-CENTER (*1)	Adjusts the horizontal/vertical position of the video that's shown in the right or lower area.	

(*1) This is valid if “PATTERN” is set to “V.CENTER” or “H.CENTER.”

2. Turn the [VALUE] knob to edit the value of the setting, and press to confirm.
3. Press the [SCENE EDIT] button several times to close the menu.

MEMO

A still image loaded into the unit (p. 15) cannot be made smaller. If you use “V.STRETCH” or “H.STRETCH” to show a still image, the stretch effect might not apply correctly depending on the resolution of the still image or the display region of the screen.

Copying a scene

Here's how to copy the settings registered in a scene to another scene.

1. [SCENE EDIT] button → select “COPY.”

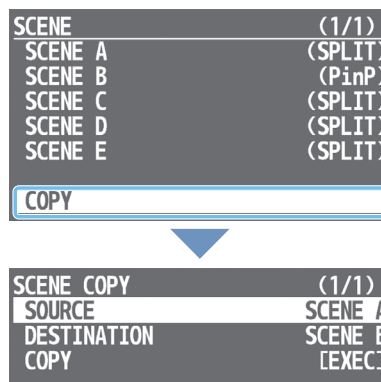

The SCENE COPY menu appears.

2. Use the [VALUE] knob to select a menu item.

Menu item	Explanation
SOURCE	Specifies the copy-source scene.
DESTINATION	Specifies the copy-destination scene.

3. Turn the [VALUE] knob to select one of “SCENE A” – “SCENE E,” and press to confirm.
4. Use the [VALUE] knob to select “COPY.”
A confirmation message appears.
If you want to cancel the operation, press the [MENU] button.
5. Turn the [VALUE] knob to select “YES,” and press to confirm.
The scene is copied. When the operation is finished, the message “COMPLETED” appears.
6. Press the [VALUE] knob to close the message.
7. Press the [SCENE EDIT] button several times to close the menu.

Compositing a Logo or Image (Luminance Key)

Black or white portions of a logo or image can be cut out based on their brightness, and overlaid onto a background video. You can also use a scene (p. 12) as the background video.



Adjusting the depth of compositing

1. Output the video that you want to use as the background video.
2. [MENU] button → “KEY” → select “SW.”

KEY	(1/1)
SW	OFF
KEY SOURCE CH	HDMI 1
KEY COLOR	BLACK
KEY LEVEL	32
KEY GAIN	4

3. Turn the [VALUE] knob to select “ON,” and press to confirm. The composited result is output.
4. Use the [VALUE] knob to select a menu item.

Menu item	Explanation
KEY SOURCE CH	Specifies the source of the logo or video that is overlaid when using key compositing. HDMI 1–3: Video being input from the VIDEO INPUT 1–3 connectors STILL IMAGE 1, 2: A still image loaded into the unit (p. 15)
KEY COLOR	Specifies the key color (black or white).
KEY LEVEL	Adjusts the degree of extraction for the key.
KEY GAIN	Adjusts the degree of edge blur for the key.

5. Turn the [VALUE] knob to edit the value of the setting, and press to confirm. Set the various menu items while you watch the composited result.
6. Press the [MENU] button several times to close the menu.

Key compositing

1. Press the [KEY] button to turn key compositing on (lit).



The logo or image is shown as a cut.

2. To turn off key compositing, press the [KEY] button once again. The background video returns as a cut.

Fading-In/Out the Main Output Video

Here’s how to perform a fade-out from the main output video to a black screen, or a fade-in from a black screen to the main output video.

A scene that you don’t want to output as video can be changed to a black screen.

* The fade-in/out effect does not apply to the video that’s output from the MONITOR (MENU) connector.

1. Press the [ON AIR] button.

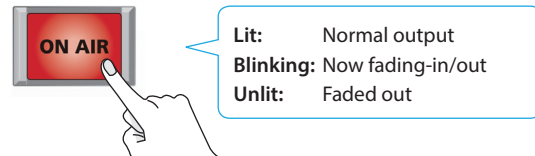

The main output video fades-out to a black screen. When fade-out is complete, the [ON AIR] button goes dark.

2. To fade-in, press the [ON AIR] button once again.

The [ON AIR] button blinks, and video output begins. When fade-in is complete, the [ON AIR] button is lit.

MEMO

- You can also fade-in/out to a white screen. Use the [MENU] button → “ON AIR” → and set “OFF COLOR” to “WHITE.”
- The fade-in/out time uses the [MENU] button → “TRANSITION” → “TIME” setting.
- With the factory settings, the video and audio fade-in/out together. If you want only the video to fade-in/out, use the [MENU] button → “ON AIR” → and set “AUDIO FADE” to “OFF.”

Outputting a Loaded Still Image

A still image that you loaded from a USB flash drive can be output in the same way as a video. You can also use it as a source for key compositing (p. 14).

NOTE

- Up to two still images can be temporarily saved in this unit's internal memory. When you turn off the power, the still images are deleted.
- When using a USB flash drive for the first time, you must format it using the VR-1HD (p. 27).
- Depending on the USB flash drive, recognition of the flash drive might take some time.
- Never turn off the power or remove the USB flash drive while the message "PROCESSING..." is shown.

Formats supported for loading

Format	Windows Bitmap File (.bmp), 24-bit color, uncompressed
Resolution	Maximum 1920 x 1200 pixels
File name	Up to eight single-byte alphanumeric characters * The extension ".bmp" must be added.

Loading a still image

Here's how to load a still image from a USB flash drive into this unit.

1. Save the still image in the root directory of the USB flash drive.
2. Connect the USB flash drive containing the still image to the USB MEMORY port.
3. [MENU] button → "USB MEMORY" → select "LOAD STILL IMAGE."

USB MEMORY	(1/1)
LOAD SETTINGS	[EXEC]
SAVE SETTINGS	[EXEC]
SAVE SETTINGS AS	[EXEC]
LOAD STILL IMAGE	1
FORMAT	[EXEC]

An internal memory in which a still image is loaded is indicated by a "*" symbol.

4. Turn the [VALUE] knob to select the loading destination for the still image (internal memory 1 or 2), and press to confirm.

A list of the still images in the USB flash drive is shown.

5. Turn the [VALUE] knob to select the still image that you want to load, and press to confirm.

A confirmation message appears.

If you want to cancel the operation, press the [MENU] button.

6. Turn the [VALUE] knob to select "YES," and press to confirm.

The still image is loaded into the unit. When the operation is finished, the message "COMPLETED" appears.

7. Press the [VALUE] knob to close the message.

8. Press the [MENU] button several times to close the menu.

Assigning a Still Image to an INPUT Button

Here's how a still image loaded into the unit can be assigned to an INPUT button.

1. [MENU] button → "VIDEO INPUT" → "INPUT 1"-"INPUT 3" → select "INPUT SOURCE."

VIDEO INPUT 1	(1/2)
STATUS	1024x768
INPUT SOURCE	STILL IMAGE 1
EDID	DEFAULT
ZOOM	100.0%
SCALING TYPE	FULL
MANUAL SIZE H	0
MANUAL SIZE V	0
POSITION H	0
POSITION V	0

2. Turn the [VALUE] knob to select "STILL IMAGE 1" or "STILL IMAGE 2," and press to confirm.

3. Press the [MENU] button several times to close the menu.

Deleting a Still Image

Here's how to delete a still image that's temporarily stored in the internal memory of the unit.

1. [MENU] button → "SYSTEM" → select "DELETE STILL IMAGE."

SYSTEM	(1/2)
HDCP	OFF
FRAME RATE	59.94Hz
TEST PATTERN	OFF
TEST TONE	OFF
PANEL LOCK	[ENTER]
LED DIMMER	7
AUTO INPUT DETECT	OFF
DELETE STILL IMAGE	*1
AUTO POWER OFF	OFF

An internal memory in which a still image is loaded is indicated by a "*" symbol.

2. Turn the [VALUE] knob to select the internal memory that you want to delete, and press to confirm.

A confirmation message appears.

If you want to cancel the operation, press the [MENU] button.

3. Turn the [VALUE] knob to select "YES," and press to confirm.

The still image is deleted. When the operation is finished, the message "COMPLETED" appears.

4. Press the [VALUE] knob to close the message.

5. Press the [MENU] button several times to close the menu.

Audio Operations

Adjusting the Mic's Input Gain (Sensitivity)

Here's how to adjust the input gain so that the mic audio is at the appropriate level.

1. Move the [MIC 1] or [MIC 2] fader whose input gain you want to adjust to the "bold line" (0 dB).

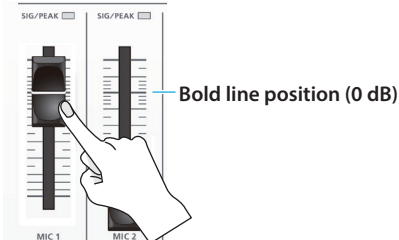

2. Move the [MAIN] knob to a position near the indicator (0 dB).



3. Use the [LEVEL SETUP] button → LEVEL SETUP (GAIN) (2/5) to select "MIC 1" or "MIC 2."

LEVEL SETUP (GAIN) (2/5)	
MIC 1	36dB
MIC 2	36dB

4. Turn the [VALUE] knob fully counter-clockwise, minimizing (0 dB) the input gain.

5. While producing the sound that will actually be input, slowly turn the [VALUE] knob clockwise to adjust the input gain.

Raise the input gain as high as possible without allowing the MIC 1 or MIC 2 SIG/PEAK indicator to light red when the loudest voice occurs.

6. Press the [VALUE] knob to confirm.

7. Press the [LEVEL SETUP] button to close the menu.

MEMO

• SIG/PEAK indicator

Indication	Explanation
Lit red	Lit when excessive input occurs (0 dB or higher).
Lit green	Lit when voice is input (-50 dB or higher).

• Adjusting the mic position (pan)

The left/right positioning of the sound is called "pan." If you're using two mics to stream a performance, panning the two mics to left and right will give the sound a more spacious feel. To make adjustments, use the [MENU] button → "AUDIO INPUT" → "MIC 1" or "MIC 2" → "PAN."

Adjusting the Volume Balance

Here's how to adjust the volume balance of each input and the overall volume.

1. Move the [MAIN] knob to a position near the indicator (0 dB).
2. While monitoring the audio via speakers or headphones, adjust the volume balance for the respective inputs.

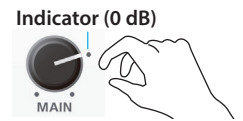

Raise the volume level of audio you want to make more prominent, for example, an emcee microphone, and lower the volume level for other audio. When no audio is input, and for audio that is unused, lower the volume level to minimum (-INF dB).

• MIC 1, MIC 2, and LINE IN

Use the [MIC 1], [MIC 2], and [LINE] faders to adjust the volume.

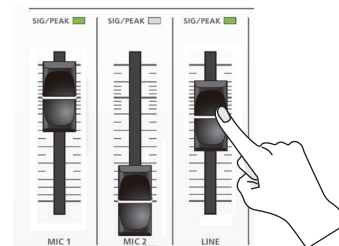

• VIDEO INPUT 1-3, USB, and music files (p. 23)

- 1 Use the [LEVEL SETUP] button → LEVEL SETUP (LEVEL) (1/5) to select the input audio.

LEVEL SETUP (LEVEL) (1/5)	
HDMI 1	0.0dB
HDMI 2	0.0dB
HDMI 3	0.0dB
USB FROM PC	0.0dB
PLAYBACK (BGM/SE)	0.0dB
AUX BUS	-INFdB

- 2 Use the [VALUE] knob to adjust the volume, and press to confirm.
- 3 Press the [LEVEL SETUP] button to close the menu.

3. Use the [MAIN] knob to adjust the volume of the main output.

The level meter will light yellow at the appropriate volume.

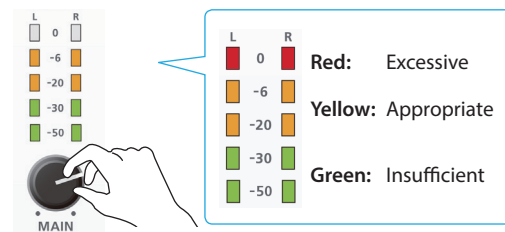

MEMO

• Adjusting the volume of the USB output

The volume of the USB output (the volume being streamed) can be adjusted separately. Use the [USB STREAM] knob to make fine adjustments to the volume of the main output. If the AUX bus is assigned to the USB STREAM port (p. 24), this adjusts the volume of the AUX bus.

- You can output a test tone that's convenient for adjusting the volume. Use the [MENU] button → "SYSTEM" → "TEST TONE" to select the type of test tone that will be output.

Reducing Acoustic Feedback (Howling Canceller)

Here's how to reduce the acoustic feedback that can occur when a mic is brought near a speaker (howling canceller function).

1. [MENU] button → "AUDIO INPUT" → "MIC 1" or "MIC 2" → select "HOWLING CANCELLER."

INPUT MIC 1 (2/2)▲	
HOWLING CANCELLER	OFF
DYNAMICS	(OFF)
EQ	(OFF)
HPF 75Hz	OFF
LOAD PRESET	[CENTER]
PHANTOM +48V	OFF

2. Turn the [VALUE] knob to select "ON," and press to confirm.
The howling canceller function turns on.
3. Press the [MENU] button several times to close the menu.

Changing the Character of a Voice (Voice Changer)

Here's how to modify the pitch or character of the voice that's input from a mic. You can create transformations such as "from a female to a male voice," "from a male to a female voice," or "robot voice."

1. Press the AUDIO EFFECTS [1] button to turn voice changer on (lit).

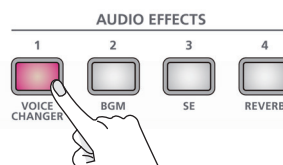

Vocalize into the mic, and the modified voice is output.

* With the factory settings, the effect is applied to the audio of MIC 1.

2. To turn voice changer off, press the AUDIO EFFECTS [1] button once again.

Adjusting the voice changer settings

1. [MENU] button → "AUDIO EFFECTS" → "EFFECTS 1" → select the menu item.

AUDIO EFFECTS 1 (1/1)	
ASSIGN	VOICE CHANGER
SW	OFF
SW MODE	LATCH
TARGET	MIC 1
PITCH	+12
FORMANT	+4
ROBOT	OFF
MIX	100
LED COLOR	MAGENTA

Menu item	Explanation
TARGET	Specifies the mic audio to which the effect applies.
PITCH	Adjusts the pitch of the voice in semitone steps. A setting of "0" is the original pitch.
FORMANT	Adjusts the character (formant) of the voice. Settings in the negative (-) direction produce a more masculine vocal character, and settings in the positive (+) direction produce a more feminine vocal character. A setting of "0" is the original voice.
ROBOT	If this is "ON," the voice is held at a fixed pitch, creating a mechanical robot-like impression.
MIX	Adjusts the balance between the unprocessed voice (0) and the voice processed by the effect (100).

2. Turn the [VALUE] knob to edit the value of the setting, and press to confirm.
3. Press the [MENU] button several times to close the menu.

MEMO

With the factory settings, the AUDIO EFFECTS [1] button is assigned the voice changer on/off function.

You can use the [MENU] button → "AUDIO EFFECTS" → "EFFECTS 1" → "EFFECTS 4" → "ASSIGN" to change the function that's assigned.

Applying Effects to Input Audio

You can apply effects to the input audio to adjust the character of the sound. The following table shows the effects that are available.

Input audio	Effect						
	Reverb	Gate	Compressor	Limiter	Equalizer	High-pass filter	Voice changer
MIC 1, 2	✓	✓	✓	✓	✓	✓	✓
LINE	✓	—	—	—	✓	—	—
VIDEO INPUT	✓	—	—	—	✓	—	—
USB	✓	—	—	—	✓	—	—
Music files (p. 23)	✓	—	—	—	✓	—	—

MEMO

- You can use effect presets for MIC 1 and MIC 2. For details, refer to "Using an Effect Preset" (p. 19).
- For more about voice changer settings, refer to "Changing the Character of a Voice (Voice Changer)" (p. 17)

- [MENU] button → "AUDIO INPUT" → "MIC 1" → "PLAYBACK (BGM/SE)" → select an effect menu item.

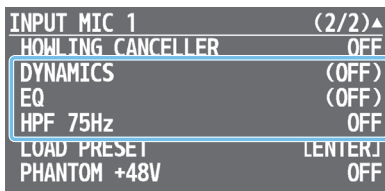
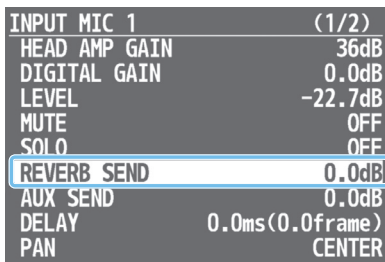

* For details on the effects, refer to the following section.

- Turn the [VALUE] knob to edit the value of the setting, and press to confirm.
- Press the [MENU] button several times to close the menu.

Gate (GATE)

Eliminates audio that is lower than the specified threshold level. This is effective when the noise that you want to remove is separate from the audio that you want to keep, and can be used to remove hiss or other noise that is heard during periods of silence.

Menu item	Explanation
DYNAMICS	Press the [VALUE] knob to access the DYNAMICS menu.
GATE	Turns the noise gate on/off.
GATE THRESHOLD	Specifies the level used as the threshold for removing audio.
GATE RELEASE	Specifies the length of time until the audio is fully attenuated after audio falls below the threshold.

Compressor/Limiter (COMP/LMT)

● Compressor

Audio that exceeds the specified threshold level is compressed. This reduces the difference between the maximum volume and minimum volume, making the audio more comfortable for listening.

● Limiter

Audio that exceeds the specified threshold level is compressed. This prevents distortion from occurring when unexpectedly loud audio is input.

* Distortion will occur if audio that exceeds the allowable range of the limiter is input.

Menu item	Explanation
DYNAMICS	Press the [VALUE] knob to access the DYNAMICS menu.
COMP/LMT	Turns the compressor or limiter on/off.
COMP/LMT TYPE	Selects the compressor or limiter. COMP1: This compressor is suitable for music. COMP2: This compressor is suitable for voice. Its effect applies more quickly than "COMP1." LIMITER: This is a limiter.
COMP/LMT THRESHOLD	Specifies the threshold at which the compressor/limiter applies.

Equalizer (EQ)

Adjusts the tone quality for each frequency band.

Menu item	Explanation
EQ	Press the [VALUE] knob to access the EQ (equalizer) menu.
SW	Turns the equalizer on/off.
HI	Boosts or attenuates the high band.
HI FREQ	Adjusts the center frequency when changing the tone quality in the high band.
MID	Boosts or attenuates the middle band.
MID FREQ	Adjusts the center frequency when changing the tone quality in the middle band.
MID Q	Adjusts the width of the frequency band when boosting or attenuating the middle band.
LO	Boosts or attenuates the low band.
LO FREQ	Adjusts the center frequency when changing the tone quality in the low band.

High-pass filter (HPF 75Hz)

Cuts off unneeded low-band audio. The cutoff frequency is 75 Hz.

Menu item	Explanation
HPF 75Hz	Turns the high-pass filter on/off.

Reverb (REVERB)

This adds reverberation to the sound.

1. [MENU] button → “AUDIO INPUT” → “MIC 1” – “PLAYBACK (BGM/SE)” → select “REVERB SEND.”
2. Turn the [VALUE] knob to adjust the amount of sound that is sent to reverb, and then press to confirm.
Adjust the depth of reverb for each audio input.
3. Press the AUDIO EFFECTS [4] button to turn reverb on (lit).

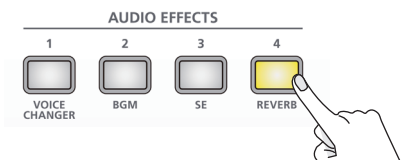

Reverb is applied.

4. To turn reverb off, press the AUDIO EFFECTS [4] button once again.

Adjusting the reverb depth

1. [MENU] button → “AUDIO EFFECTS” → “EFFECTS 4” (ASSIGN=REVERB) → select “LEVEL,” “TIME,” or “TYPE.”

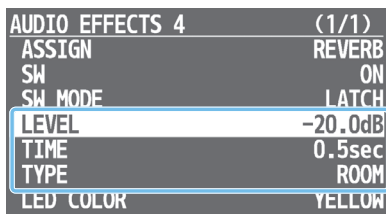

Menu item	Explanation
LEVEL	Sets the amount of sound that is returned from the reverb (return level). This adjusts the depth of the overall reverb.
TIME	Specifies the time until the reverberation is no longer heard.
TYPE	Specifies the reverb type. ROOM: Produces the natural-sounding reverberation of a room. HALL: Produces the reverberation that is typical of a performance in a concert hall.

2. Turn the [VALUE] knob to edit the value of the setting, and press to confirm.
3. Press the [MENU] button several times to close the menu.

MEMO

With the factory settings, the AUDIO EFFECTS [4] button is assigned the reverb on/off function.

You can use the [MENU] button → “AUDIO EFFECTS” → “EFFECTS 1” – “EFFECTS 4” → “ASSIGN” to change the function that’s assigned.

Using an Effect Preset

The VR-1HD provides effect presets for the mics. Simply by selecting a preset, you can easily apply the effect that’s appropriate for your situation.

Each preset consists of a combination of two effects (equalizer, high-pass filter).

* When you switch presets, the settings of each effect are overwritten.

1. [MENU] button → “AUDIO INPUT” → “MIC 1” or “MIC 2” → select “LOAD PRESET.”

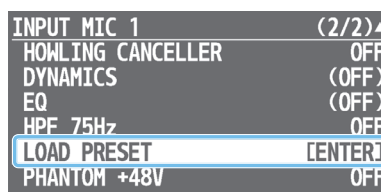

The preset list appears.

2. Turn the [VALUE] knob to select an effect preset, and press to confirm.

Value	Explanation
DEFAULT	Flat settings that do not apply any effect.
WIND NR	Reduces wind noise.
VIBRATION NR	Reduces vibration and other low-frequency noise.
LIP NR	Reduces noises produced by the lips when speaking or singing. This is appropriate for vocal input.
SPEECH	Makes a spoken voice easier to understand.
VOCAL	Enhances a singing voice.

A confirmation message appears.

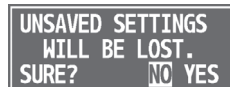

If you want to cancel the operation, press the [MENU] button.

3. Turn the [VALUE] knob to select “YES,” and press to confirm.

The preset is loaded. When the operation is finished, the message “COMPLETED” appears.

4. Press the [VALUE] knob to close the message.
5. Press the [MENU] button several times to close the menu.

Applying Effects to Output Audio

Here's how to modify the tonal character by applying effects to the audio output.

1. [MENU] button → "AUDIO OUTPUT" → "MAIN BUS" or "AUX BUS" → select an effect menu item.

MAIN BUS	(1/1)
LEVEL	0.0dB
MUTE	OFF
LIMITER	OFF
LIMITER THRESHOLD	-6.0dB
EQ	(OFF)

* For details on the effects, refer to the following section.

2. Turn the [VALUE] knob to edit the value of the setting, and press to confirm.
3. Press the [MENU] button several times to close the menu.

Limiter (LIMITER)

Compresses the audio so that the mixed audio does not exceed the specified threshold level.

* Distortion will occur if audio that exceeds the allowable range of the limiter is input.

Menu item	Explanation
LIMITER	Turns the limiter on/off.
LIMITER THRESHOLD	Specifies the threshold at which the limiter applies.

Equalizer (EQ)

Adjusts the tone quality for each frequency band.

Menu item	Explanation
EQ	Press the [VALUE] knob to access the EQ (equalizer) menu.
SW	Turns the equalizer on/off.
HI	Boosts or attenuates the high band.
HI FREQ	Adjusts the center frequency when changing the tone quality in the high band.
MID	Boosts or attenuates the middle band.
MID FREQ	Adjusts the center frequency when changing the tone quality in the middle band.
MID Q	Adjusts the width of the frequency band when boosting or attenuating the middle band.
LO	Boosts or attenuates the low band.
LO FREQ	Adjusts the center frequency when changing the tone quality in the low band.

Correcting a Time Difference Between Video and Audio (Delay)

If there is a timing discrepancy between the video and audio, you can correct the output timing by delaying the audio output.

1. [MENU] button → "AUDIO INPUT" → "MIC 1"-"USB FROM PC" → select "DELAY."

INPUT MIC 1	(1/2)
HEAD AMP GAIN	36dB
DIGITAL GAIN	0.0dB
LEVEL	0.0dB
MUTE	OFF
SOLO	OFF
REVERB SEND	0.0dB
AUX SEND	0.0dB
DELAY	0.0ms(0.0frame)
PAN	CENTER

2. Turn the [VALUE] knob to adjust the delay time of the input audio, and press to confirm.
3. Press the [MENU] button several times to close the menu.

MEMO

For the USB STREAM port and AUX bus (p. 24), you can adjust the delay time of the audio output.

Press the [MENU] button → "AUDIO OUTPUT" → "USB STREAM" or "AUX BUS" → and adjust "DELAY."

Silencing Only Specific Audio (Mute)

Here's how to temporarily silence specific input audio or output audio (the mute function).

Muting input audio

1. [MENU] button → "AUDIO INPUT" → "MIC 1"-"PLAYBACK (BGM/SE)" → select "MUTE."

INPUT MIC 1	(1/2)
HEAD AMP GAIN	36dB
DIGITAL GAIN	0.0dB
LEVEL	0.0dB
MUTE	OFF
SOLO	OFF
REVERB SEND	0.0dB
AUX SEND	0.0dB
DELAY	0.0ms(0.0frame)
PAN	CENTER

2. Turn the [VALUE] knob to select "ON," and press to confirm.
3. Press the [MENU] button several times to close the menu.

Muting output audio

Here's how to mute the audio of the main output (main bus), AUX bus (p. 24), or USB output.

1. [MENU] button → "AUDIO OUTPUT" → "MAIN BUS," "AUX BUS," or "USB STREAM" → select "MUTE."

MAIN BUS	(1/1)
LEVEL	0.0dB
MUTE	OFF
LIMITER	OFF
LIMITER THRESHOLD	-6.0dB
EQ	(OFF)

2. Turn the [VALUE] knob to select "ON," and press to confirm.
3. Press the [MENU] button several times to close the menu.

MEMO

You can assign the mute function to an AUDIO EFFECTS button and turn it on/off.

Press the [MENU] button → "AUDIO EFFECTS" → "EFFECTS 1" –"EFFECTS 4" → use the following menu items to change the function assignment.

Menu item	Explanation
ASSIGN	Choose "MUTE."
CH	Specify the audio that will be affected by the operation.

Checking a Specific Audio Input (Solo)

Here's how you can temporarily monitor a specific audio input via the headphones (solo function).

* The solo function applies to the headphone output. It does not affect output other than the headphones.

1. [MENU] button → "AUDIO INPUT" → "MIC 1"-"PLAYBACK (BGM/SE)" → select "SOLO."

INPUT MIC 1	(1/2)
HEAD AMP GAIN	36dB
DIGITAL GAIN	0.0dB
LEVEL	0.0dB
MUTE	OFF
SOLO	OFF
REVERB SEND	0.0dB
AUX SEND	0.0dB
DELAY	0.0ms(0.0frame)
PAN	CENTER

2. Turn the [VALUE] knob to select "ON," and press to confirm.
3. Press the [MENU] button several times to close the menu.

MEMO

You can assign the solo function to an AUDIO EFFECTS button and turn it on/off.

Press the [MENU] button → "AUDIO EFFECTS" → "EFFECTS 1" –"EFFECTS 4" → use the following menu items to change the function assignment.

Menu item	Explanation
ASSIGN	Choose "SOLO."
CH	Specify the audio that will be affected by the operation.

Interlinking Audio Output to Video Switching (Audio Follow)

Here's how the audio output can be automatically switched in tandem with video switching (the audio follow function).

1. [MENU] button → "AUDIO FOLLOWS VIDEO" → select "HDMI 1 SW"–"HDMI 3 SW."

AUDIO FOLLOWS VIDEO (1/1)	
HDMI 1 SW	ON
HDMI 2 SW	ON
HDMI 3 SW	ON
MIC 1 SW	OFF
MIC 2 SW	OFF
LINE SW	OFF
USB FROM PC SW	OFF
PLAYBACK(BGM/SE) SW	OFF

2. Turn the [VALUE] knob to select "ON," and press to confirm.

Value	Explanation
ON	The video and audio from HDMI input are switched together.
OFF	The audio is always output regardless of the input video selection.

3. Press the [MENU] button several times to close the menu.

Adding an object for audio follow

Here's how an audio input source other than VIDEO INPUT 1–3 can be specified as an object for the audio follow function.

1. [MENU] button → "AUDIO FOLLOWS VIDEO" → and select the audio input that will be the object of the audio follow function.

AUDIO FOLLOWS VIDEO (1/1)	
HDMI 1 SW	ON
HDMI 2 SW	ON
HDMI 3 SW	ON
MIC 1 SW	OFF
MIC 2 SW	OFF
LINE SW	OFF
USB FROM PC SW	OFF
PLAYBACK(BGM/SE) SW	OFF

Menu item	Explanation
MIC 1 SW	MIC 1 input
MIC 2 SW	MIC 2 input
LINE SW	LINE input
USB FROM PC SW	USB input
PLAYBACK (BGM/SE) SW	Music files (p. 23)

2. Turn the [VALUE] knob to select one of "INPUT 1"–"INPUT 3," and press to confirm.

Value	Explanation
INPUT 1–3	For each audio source, these settings specify the input video (INPUT 1–3) that will use the audio follow function. Audio is output only when the specified input video is selected.
OFF	The audio is always output regardless of the input video selection.

3. Press the [MENU] button several times to close the menu.

Controlling the Volume Automatically (Auto Mixing)

The volume adjustments that would normally be done by the operator can be controlled automatically (auto mixing function). Since this lets you leave the volume adjustments up to the VR-1HD, it can be used in situations where there is no dedicated operator.

1. [MENU] button → "AUTO MIXING" → select "SW."

AUTO MIXING (1/1)	
SW	OFF
MIC 1 SW	ON
MIC 2 SW	ON
LINE SW	OFF
HDMI 1 SW	OFF
HDMI 2 SW	OFF
HDMI 3 SW	OFF
USB FROM PC SW	OFF

2. Turn the [VALUE] knob to select "ON," and press to confirm.

The auto mixing function turns on.

3. Use the [VALUE] knob to select the audio whose setting you want to specify.

Menu item	Explanation
MIC 1 SW	MIC 1 input
MIC 2 SW	MIC 2 input
LINE SW	LINE input
HDMI 1 SW	VIDEO INPUT 1 input
HDMI 2 SW	VIDEO INPUT 2 input
HDMI 3 SW	VIDEO INPUT 3 input
USB FROM PC SW	USB input

4. Turn the [VALUE] knob to specify whether the selected audio is affected (ON) or is not affected (OFF) by auto mixing, and press to confirm.

For audio that does not require auto mixing, such as background music, choose "OFF."

5. Press the [MENU] button several times to close the menu.

Playing Back Music Files

Here's how to play back the internal music files or music files (.wav) that are saved on a USB flash drive. By playing back sound effects such as jingles or applause, or background music, you can make your stream or program more enjoyable.

NOTE

- When using a USB flash drive for the first time, you must format it using the VR-1HD (p. 27).
- Depending on the USB flash drive, recognition of the flash drive might take some time.

Music files that can be played

Format (extension)	WAV (.wav)
Sample rate	44.1, 48 kHz
Bit depth	16 bits
Number of channels	Stereo, mono
File size	2 GB or less
File name	Up to eight single-byte alphanumeric characters * The extension ".wav" must be added.

Playing back

1. Press the AUDIO EFFECTS [2] or [3] button.

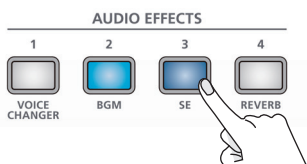

The button lights, and the music file plays.

* With the factory settings, an internal music file will play.

[2] button	BriskAfternoon: background music sample
[3] button	Applause: sound effect sample (applause)

2. To stop the music file, press the AUDIO EFFECTS [2] or [3] button once again.

If loop playback is off, the music file stops automatically when it has played to the end.

MEMO

- Music files shorter than 10 ms might not play correctly.
- The VR-1HD plays back the music file directly from the connected USB flash drive. Even if a music file on the USB flash drive is selected, it will not play unless the USB flash drive is connected.
- With the factory settings, the AUDIO EFFECTS [2][3] buttons are assigned the music file play/stop function "PLAYBACK (BGM/SE)." You can use the [MENU] button → "AUDIO EFFECTS" → "EFFECTS 1"–"EFFECTS 4" → "ASSIGN" to change the function that's assigned.

Selecting a music file from a USB flash drive

Here's how to play back a music file that's saved on a USB flash drive.

1. Save the music file in the root directory of the USB flash drive.
2. Connect the USB flash drive containing the music file to the USB MEMORY port.
3. [MENU] button → "AUDIO EFFECTS" → "EFFECTS 2" or "EFFECTS 3" → select "AUDIO ASSIGN."

AUDIO EFFECTS 2	(1/1)
ASSIGN	PLAYBACK(BGM/SE)
SW	ON
SW MODE	LATCH
AUDIO ASSIGN	BriskAfternoon
LEVEL	0.0dB
LOOP	ON
FADE IN	OFF
FADE OUT	3.0sec
LED COLOR	CYAN

AUDIO ASSIGN 2	
BriskAfternoon	
Applause	
USB MEMORY	[ENTER]

A list of clips appears. "BriskAfternoon" and "Applause" are internal music files.

4. Use the [VALUE] knob to select "USB MEMORY." A list of the music files on the USB flash drive appears.
5. Turn the [VALUE] knob to select the music file that you want to play, and press to confirm. A confirmation message appears. If you want to cancel the operation, press the [MENU] button.
6. Turn the [VALUE] knob to select "YES," then press the knob to confirm. The message "COMPLETED" appears.
7. Press the [VALUE] knob to close the message.
8. Press the [MENU] button several times to close the menu.

Specifying the playback method

You can make the music file play as a loop, or make it fade-in/out. Press the [MENU] button → "AUDIO EFFECTS" → choose "EFFECTS 1"–"EFFECTS 4," and set the following menu items.

● When ASSIGN = PLAYBACK (BGM/SE)

Menu item	Explanation
LEVEL	Adjusts the playback volume of the music file.
LOOP	Turns loop playback on/off.
FADE IN	Specifies the fade-in time of the music file.
FADE OUT	Specifies the fade-out time of the music file.

Suppressing Echo in a Web Conference System (Echo Canceller)

In a conversation using the speaker and mic of a web conference system, an echo can occur when the other person's voice heard through the speaker is picked up by the mic and sent back to the other person.

When you use the echo canceller function, the echo component is removed from the voice that is picked up by a mic connected to the VR-1HD, so that only your own voice is sent to the other party.

1. [MENU] button → "ECHO CANCELLER" → select "MIC 1 SW" or "MIC 2 SW."

ECHO CANCELLER (1/1)	
MIC 1 SW	OFF
MIC 2 SW	OFF
MIC 1 DEPTH	5
MIC 2 DEPTH	5

2. Turn the [VALUE] knob to select "ON," and press to confirm.
The echo canceller function turns on.
3. Use the [VALUE] knob to select "MIC 1 DEPTH" or "MIC 2 DEPTH."
4. Turn the [VALUE] knob to adjust the depth (1–10) of the echo canceller, and press to confirm.
Use the setting that produces the greatest reduction in the echo.
5. Press the [MENU] button several times to close the menu.

MEMO

- The echo canceller function supports rooms that are approximately 20m² (215 sq ft).
- If your own voice returns to you as an echo, you'll need the other party to make echo canceller settings.

About the AUX Bus

A "bus" is a destination to which input audio is mixed and sent. The VR-1HD has two buses: the "main bus" and the "AUX bus." With the exception of the MAIN connector, you can assign a desired bus to each output connector.

● Main bus

This mixes and outputs all input audio. This is the same audio as the main output.

● AUX bus

This mixes and outputs only the input audio that is sent to the AUX bus. This allows you to output audio that is different than the main output.

For example, in a live event, you might output a mix of all audio inputs (the main bus), while separately outputting a mix of only specific audio inputs (the AUX bus) for recording or streaming.

Assigning the AUX bus

1. [MENU] button → "AUDIO OUTPUT" → "BUS SELECT" → select the output jack.

BUS_SELECT (1/1)	
MONITOR	MAIN
USB_STREAM	MAIN
LINE_OUT	MAIN
PHONES	MAIN

2. Turn the [VALUE] knob to select "AUX," and press to confirm.
3. Press the [MENU] button several times to close the menu.

Sending audio to the AUX bus

Press the [MENU] button → "AUDIO INPUT" → "MIC 1"-"PLAYBACK (BGM/SE)" → "AUX SEND" to adjust the amount that is sent to the AUX bus.

Adjusting the audio of the AUX bus

Press the [MENU] button → "AUDIO OUTPUT" → "AUX BUS" → use the following menu items to adjust the audio of the AUX bus.

Menu item	Explanation
LEVEL	Adjusts the volume
MUTE	Turns mute on/off (p. 21)
LIMITER	Limiter (p. 20)
LIMITER THRESHOLD	
DELAY	Delay (p. 20)
EQ	Equalizer (p. 20)

Live Streaming

Outputting Video/Audio to a Computer for Streaming

Here's how the video and audio mixed by the VR-1HD can be output to a connected computer. You can also input audio that's played back by the computer.

By using an internet-connected computer with streaming software, you can distribute content as a live internet stream.

* In order for the audio and video from the VR-1HD to be correctly viewed on the computer, software that supports the USB video class and USB audio class must be installed on the computer.

* For the latest operating requirements, refer to the Roland website (<https://proav.roland.com/>).

Outputting video and audio to the computer

1. Using a USB 3.0 cable, connect a USB 3.0 port on the computer to the USB STREAM port on the VR-1HD.

2. Turn on the power to the VR-1HD.

3. Start the computer.

When communication with the computer has been established, the computer recognizes the VR-1HD as a USB video device and USB audio device.

* The first time that the VR-1HD is connected to the computer, the standard drivers of the operating system are installed automatically.

4. Operate the VR-1HD to prepare the video and audio that you want to output to the computer.

5. On your computer, verify the input from the VR-1HD.

Start software that supports the USB video class and audio class, and verify the video and audio that are being input from the VR-1HD.

MEMO

If the video is garbled or operation is otherwise unstable

Press the [MENU] button → "VIDEO OUTPUT" → "USB STREAM"
→ execute "CONNECTION RESET" to try reconnecting the computer with the VR-1HD.

Using the loopback function

Audio from the computer can be input to the VR-1HD via USB, mixed with other audio, and returned to the computer (the loopback function).

You can add a narration to music that's played back from your computer and live-stream it, or record it using software on your computer.

Capturing video on the computer

Using dedicated "Video Capture for VR" software, the video and audio that are output from the VR-1HD via USB can be recorded on your computer.

For details on operation, refer to the Owner's Manual included with "Video Capture for VR."



You can download "Video Capture for VR" from the Roland website. <https://proav.roland.com/>

Other Features

Saving Internal Settings to a USB Flash Drive

You can save the settings of this unit as a single file (.VR1) to a USB flash drive connected to the USB MEMORY port. You can use the saved settings file by loading it from the USB flash drive into this unit when necessary.

NOTE

- When using a USB flash drive for the first time, you must format it using the VR-1HD (p. 27).
- Never turn off the power or remove the USB flash drive while the message "PROCESSING..." is shown.
- Depending on the USB flash drive, recognition of the flash drive might take some time.

Saving a new file

1. [MENU] button → "USB MEMORY" → select "SAVE SETTINGS AS."

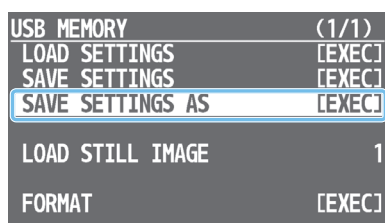

"SYS + consecutive four-digit number. VR1" is specified as the file name.

A confirmation message appears.

If you want to cancel the operation, press the [MENU] button.

2. Turn the [VALUE] knob to select "YES," then press the knob to confirm.

The current settings are saved to the USB flash drive as a file. When the operation is finished, the message "COMPLETED" appears.



3. Press the [VALUE] knob to close the message.
4. Press the [MENU] button several times to close the menu.

MEMO

Content that is not saved to the file

- The SYSTEM menu settings "TEST PATTERN" and "TEST TONE." The unit always starts with these "OFF."
- The still images loaded into the unit. Only the file names of the still images are saved.
- The state of the [ON AIR] button. The unit always starts with this lit.
- The state of an AUDIO EFFECTS button to which "PLAYBACK (BGM/SE)" is assigned. The unit always starts with this off.
- The positions of the volume knobs and faders.

Overwrite-saving

1. [MENU] button → "USB MEMORY" → select "SAVE SETTINGS."

The settings files in the USB flash drive are listed.

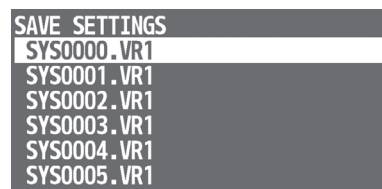

2. Turn the [VALUE] knob to select the settings file that you want to overwrite, and press to confirm.

A confirmation message appears.

If you want to cancel the operation, press the [MENU] button.

3. Turn the [VALUE] knob to select "YES," and press to confirm.

The settings file is overwrite-saved. When the operation is finished, the message "COMPLETED" appears.

4. Press the [VALUE] knob to close the message.

5. Press the [MENU] button several times to close the menu.

Loading

Here's how to load this unit's settings that you saved on a USB flash drive. When you load settings, the current settings are overwritten.

1. [MENU] button → "USB MEMORY" → select "LOAD SETTINGS."

The settings files in the USB flash drive are listed.

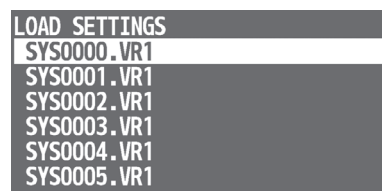

2. Turn the [VALUE] knob to select the settings file that you want to load, and press to confirm.

A confirmation message appears.

If you want to cancel the operation, press the [MENU] button.

3. Turn the [VALUE] knob to select "YES," and press to confirm.

The settings are loaded. When the operation is finished, the message "COMPLETED" appears.

4. Press the [VALUE] knob to close the message.

5. Press the [MENU] button several times to close the menu.

Formatting a USB Flash Drive

The first time that you use a USB flash drive, you must use the VR-1HD to format it.

NOTE

- A USB flash drive that was not formatted by the VR-1HD will not be recognized.
- Never turn off the power or remove the USB flash drive while the message "PROCESSING..." is shown.
- When you format a USB flash drive, all data on that USB flash drive is erased. If the drive contains important data, back it up to your computer before you format the drive.

1. Connect the USB flash drive to the USB MEMORY port.



* Ensure that the USB flash drive is oriented correctly, and insert it all the way into the port. Do not use excessive force.

2. [MENU] button → "USB MEMORY" → select "FORMAT."

USB MEMORY	(1/1)
LOAD SETTINGS	[EXEC]
SAVE SETTINGS	[EXEC]
SAVE SETTINGS AS	[EXEC]
LOAD STILL IMAGE	1
FORMAT	[EXEC]

FORMAT SURE?	NO YES
--------------	--------

A confirmation message appears.

If you want to cancel the operation, press the [MENU] button.

3. Turn the [VALUE] knob to select "YES," and press to confirm.

Formatting is executed. When the operation is finished, the message "COMPLETED" appears.

COMPLETED	[CENTER]
-----------	----------

4. Press the [VALUE] knob to close the message.

5. Press the [MENU] button several times to close the menu.

Disabling Panel Operations (Panel Lock)

You can disable operation of the panel's buttons and knobs to prevent unintended operations (Panel Lock function).

Selecting the objects of panel lock

1. [MENU] button → "SYSTEM" → select "PANEL LOCK."

SYSTEM	(1/2)
HDCP	OFF
FRAME RATE	59.94Hz
TEST PATTERN	OFF
TEST TONE	OFF
PANEL LOCK	[CENTER]
LED DIMMER	7
AUTO INPUT DETECT	OFF
DELETE STILL IMAGE	1
AUTO POWER OFF	OFF

PANEL LOCK	(1/2)
ALL	OFF
MENU	OFF
VALUE	OFF
INPUT SELECT	OFF
SCENE EDIT	OFF
SCENE SELECT	OFF
AUTO SW	OFF
ON AIR	OFF
KEY	OFF

The PANEL LOCK menu appears.

2. Use the [VALUE] knob to select the object (button or knob) for which you want to make settings.

By choosing "ALL" you can select all buttons and knobs in a single operation.

3. Turn the [VALUE] knob to specify whether panel lock will (ON) or will not (OFF) affect the object, and then press to confirm.

4. Press the [MENU] button several times to close the menu.

Locking or unlocking the operation panel

1. Simultaneously hold down the [MENU] button and [SCENE EDIT] button for three seconds or longer.

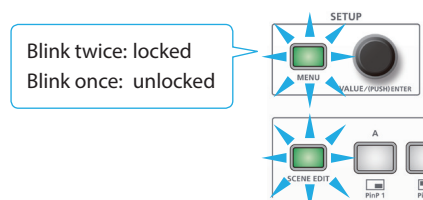

The [MENU] button and [SCENE EDIT] button blink twice, and the operation panel is locked.

2. To unlock, simultaneously hold down the [MENU] button and [SCENE EDIT] button once again for three seconds or longer.

The [MENU] button and [SCENE EDIT] button blink once, and the operation panel is unlocked.

Returning to the Factory Settings (Factory Reset)

Here's how you can return the settings of the VR-1HD to their factory-set state. If following the procedures described in this manual does not cause the result you expect, try executing a factory reset.

NOTE

When you execute factory reset, all previously specified content and the still image (p. 15) that was loaded into the unit will be lost.

1. [MENU] button → "SYSTEM" → select "FACTORY RESET."



A confirmation message appears.
If you want to cancel the operation, press the [MENU] button.

2. Turn the [VALUE] knob to select "YES," and press to confirm.

Factory reset is executed. When the operation is finished, the message "COMPLETED" appears.



3. Press the [VALUE] knob to close the message.
4. Press the [MENU] button several times to close the menu.

MEMO

By turning on the power while you hold down the AUDIO EFFECTS [1] button, you can execute factory reset at startup.

Menu List

Pressing the [MENU] button makes the menu appear on the display connected to the MONITOR (MENU) connector.



MEMO

- By turning the [VALUE] knob while pressing it, you can change the value more greatly.
- Long-pressing the [VALUE] knob returns the current menu item you're setting to its default value.
- When you press the [LEVEL SETUP] button, the menu for volume, input gain, solo, and mute settings appears (p. 42).
- There are shortcuts that let you quickly access the menu for specific buttons and knobs.
For details, refer to "Shortcut List" (p. 48).

VIDEO INPUT Menu

Menu item	Value (bold text: default value)	Explanation
INPUT 1–3	Adjust the videos that are assigned to the INPUT [1]–[3] buttons.	
STATUS	—	Indicates the format of the video source. If no video is being input, this indicates "NO SIGNAL." If no still image is loaded into the unit, this indicates "NO IMAGE."
INPUT SOURCE	Specifies the video sources that you want to assign to the INPUT [1]–[3] buttons.	
	HDMI	The video being input from the VIDEO INPUT connector
	STILL IMAGE 1, 2	A still image loaded into the unit
EDID	BLACK, WHITE, GRAY, GREEN, BLUE	Single-color screen
	DEFAULT	Specifies the input format (EDID).
	720p	If this is "DEFAULT," EDID information for all formats that can be input to the VR-1HD will be transmitted.
	1080i	
	1080p	
	1024x768	* When you change the setting, the change is not applied until you press the [VALUE] knob to confirm.
	1280x800	
	1366x768	
	1280x1024	What is EDID?
	1400x1050	EDID is data that is transmitted from the VR-1HD to the source device when the VR-1HD is connected to a source device. EDID contains data such as the formats that can be input to the VR-1HD (resolution, color space, color depth) and audio information.
1600x1200	Based on the EDID information that the source device receives, it will output the most appropriate video format to the VR-1HD.	
1920x1080		
1920x1200		
ZOOM	10.0– 100.0 –1000.0% (*1) (*2)	Adjusts the zoom ratio.
SCALING TYPE	Specifies the scaling type. (*2)	
	FULL	Always displays the picture expanded to full screen, irrespective of the aspect ratio of the input video.
	LETTERBOX	Enlarges or reduces the incoming video to a full-screen view while keeping the aspect ratio unchanged.
	CROP	Enlarges or reduces the incoming video so that the output picture has no blank margins while keeping the aspect ratio unchanged. Video extending beyond the borders is cut off.
	DOT BY DOT	Performs no scaling.
MANUAL SIZE H	-2000– 0 –2000 (*1) (*2)	Adjusts the horizontal size.
MANUAL SIZE V	-2000– 0 –2000 (*1) (*2)	Adjusts the vertical size.
POSITION H	-1920– 0 –1920	Adjusts the display position in the horizontal direction.
POSITION V	-1200– 0 –1200	Adjusts the display position in the vertical direction.
BRIGHTNESS	-64– 0 –64	Adjusts the brightness.
CONTRAST	-64– 0 –64	Adjusts the contrast.
SATURATION	-64– 0 –64	Adjusts the saturation.
RED	-64– 0 –64	Adjusts the red level.
GREEN	-64– 0 –64	Adjusts the green level.
BLUE	-64– 0 –64	Adjusts the blue level.
COLOR SPACE	RGB 0–255, RGB 16–235, YCC SD, YCC HD, AUTO	Specifies the color space (system for representing colors in video). If this is set to "AUTO," an appropriate color space is automatically applied.
FLICKER FILTER	OFF , ON	If this is "ON," flickering is reduced.

(*1) The valid range of setting values depends on conditions such as the input/output format. In some cases, changing the value of a setting might not affect the video.

(*2) A still image loaded into the unit cannot be made smaller. If resizing would make the still image smaller than its original size, it will not be resized (smaller), but instead a portion of the still image will be cut out for display.

VIDEO OUTPUT Menu

Menu item	Value (bold text: default value)	Explanation
OUTPUT FORMAT	720p 1080i 1080p 1024x768 1280x800 1366x768 1280x1024 1400x1050 1600x1200 1920x1080 1920x1200	Specifies the output format of the MAIN/MONITOR (MENU) connector. * When you change the setting, the change is not applied until you press the [VALUE] knob to confirm.
USB FORMAT	1920x1080/29.97p (25p) 1280x720/59.94p (50p) 1280x720/29.97p (25p) 854x480/59.94p (50p) 854x480/29.97p (25p)	Specifies the output format of the USB STREAM connector. This further converts the video that was format-converted by "OUTPUT FORMAT" into a format that can be streamed. * The numerical value in parentheses is the frame rate when the SYSTEM menu setting "FRAME RATE" is set to "50 Hz." * When you change the setting, the change is not applied until you press the [VALUE] knob to confirm.
MAIN OUTPUT	Adjusts the video that is output from the MAIN connector (the main output video).	
STATUS	—	Indicates the connection status of the MAIN connector.
COLOR SPACE	RGB 0–255 , RGB 16–235, YCC	Specifies the color space (system for representing colors in video).
DVI-D/HDMI	HDMI , DVI-D	Specifies the type of output signal.
ZOOM	10.0– 100.0 –1000.0%	Adjusts the zoom ratio.
POSITION H	-1920– 0 –1920	Adjusts the display position in the horizontal direction.
POSITION V	-1200– 0 –1200	Adjusts the display position in the vertical direction.
BRIGHTNESS	-64– 0 –64	Adjusts the brightness.
CONTRAST	-64– 0 –64	Adjusts the contrast.
SATURATION	-64– 0 –64	Adjusts the saturation.
RED	-64– 0 –64	Adjusts the red level.
GREEN	-64– 0 –64	Adjusts the green level.
BLUE	-64– 0 –64	Adjusts the blue level.
MONITOR (MENU) OUTPUT	Adjusts the video that is output from the MONITOR (MENU) connector.	
STATUS	—	Indicates the connection status of the MONITOR (MENU) connector.
COLOR SPACE	RGB 0–255 , RGB 16–235, YCC	Specifies the color space (system for representing colors in video).
DVI-D/HDMI	HDMI , DVI-D	Specifies the type of output signal.
BRIGHTNESS	-64– 0 –64	Adjusts the brightness.
CONTRAST	-64– 0 –64	Adjusts the contrast.
SATURATION	-64– 0 –64	Adjusts the saturation.
RED	-64– 0 –64	Adjusts the red level.
GREEN	-64– 0 –64	Adjusts the green level.
BLUE	-64– 0 –64	Adjusts the blue level.
USB STREAM	Adjusts the video that is output from the USB STREAM connector.	
STATUS	(HIGH SPEED, SUPER SPEED)	Indicates whether the connection uses USB 2.0 (HIGH SPEED) or USB 3.0 (SUPER SPEED). If not connected to a computer, this indicates "NOT CONNECTED."
ZOOM	10.0– 100.0 –1000.0%	Adjusts the zoom ratio.
SCALING TYPE	Specifies the scaling type.	
	FULL	Always displays the picture expanded to full screen, irrespective of the aspect ratio of the input video.
	LETTERBOX	Enlarges or reduces the incoming video to a full-screen view while keeping the aspect ratio unchanged.
	CROP	Enlarges or reduces the incoming video so that the output picture has no blank margins while keeping the aspect ratio unchanged. Video extending beyond the borders is cut off.
	DOT BY DOT	Performs no scaling.
MANUAL SIZE H	-2000– 0 –2000 (*3)	Adjusts the horizontal size.
MANUAL SIZE V	-2000– 0 –2000 (*3)	Adjusts the vertical size.
POSITION H	-1920– 0 –1920	Adjusts the display position in the horizontal direction.
POSITION V	-1200– 0 –1200	Adjusts the display position in the vertical direction.
CONNECTION RESET	[EXEC]	Reconnects the computer and the VR-1HD when the video is garbled or when operation is otherwise unstable.

(*3) The valid range of setting values depends on conditions such as the input/output format. In some cases, changing the value of a setting might not affect the video.

SCENE Menu

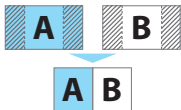
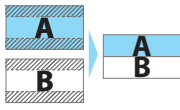
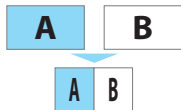
Menu item	Value (bold text: default value)	Explanation	
SCENE A-E (*4)	Adjusts the screen layouts that are registered in scenes A-E.		
TYPE	Specifies the type of screen layout.		
	PinP	An inset screen (a small different screen) is overlaid on the background video (picture-in-picture).	
	SPLIT	The screen is divided into left/right or upper/lower halves, and two videos are shown.	
When TYPE = PinP			
BACKGROUND CH	INPUT 1-3 (*5)	Specifies the background video.	
WINDOW CH	INPUT 1-3 (*5)	Specifies the inset screen video. * A still image loaded into the unit cannot be made smaller. If the still image is shown in the inset screen, a portion of the still image is cut out and shown, instead of making it smaller to match the size of the inset screen.	
WINDOW POSITION H	-100.0-100.0%	Adjusts the horizontal display position of the inset screen.	
WINDOW POSITION V	-100.0-100.0%	Adjusts the vertical display position of the inset screen.	
WINDOW ASPECT	1 : 1, 4 : 3, 3 : 2, 16 : 9	Specifies the aspect ratio of the inset screen.	
WINDOW SIZE	10.0-100.0%	Adjusts the size of the inset screen.	
WINDOW CROPPING H	0.0-100.0%	Adjusts the horizontal size of the inset screen.	
WINDOW CROPPING V	0.0-100.0%	Adjusts the vertical size of the inset screen.	
VIEW POSITION H	-100.0-100.0%	Adjusts the horizontal position of the video shown in the inset screen.	
VIEW POSITION V	-100.0-100.0%	Adjusts the vertical position of the video shown in the inset screen.	
VIEW ZOOM	100.0-1000.0%	Adjusts the zoom of the video shown in the inset screen.	
When TYPE = SPLIT			
PATTERN	Specifies the pattern for the split.		
	<p>V.CENTER Vertically cuts-out the center of the video.</p> 	<p>H.CENTER Horizontally cuts-out the center of the video.</p> 	<p>V.STRETCH Vertically shrinks the video.</p> 
* A still image loaded into the unit cannot be made smaller. If you use "V.STRETCH" or "H.STRETCH" to show a still image, the stretch effect might not apply correctly depending on the resolution of the still image or the display region of the screen.			
CENTER	0.0-100.0%	Adjusts the position at which the screen is divided.	
A CH (LEFT/UPPER)	INPUT 1-3 (*5)	Specifies the video that is shown in the left or upper side.	
B CH (RIGHT/LOWER)	INPUT 1-3 (*5)	Specifies the video that is shown in the right or lower side.	
A-CENTER	-25.0-25.0%	This is valid if "PATTERN" is set to "V.CENTER" or "H.CENTER." When using V.CENTER Adjusts the horizontal position of the video that is shown on the left side. When using H.CENTER Adjusts the vertical position of the video that is shown on the upper side.	
B-CENTER	-25.0-25.0%	This is valid if "PATTERN" is set to "V.CENTER" or "H.CENTER." When using V.CENTER Adjusts the horizontal position of the video that is shown on the right side. When using H.CENTER Adjusts the vertical position of the video that is shown on the lower side.	
COPY	Specifies settings for copying a scene.		
SOURCE	SCENE A-E	Specifies the copy-source scene.	
DESTINATION	SCENE A-B-E	Specifies the copy-destination scene.	
COPY	[EXEC]	Executes the scene copy.	

(*4) The factory settings for SCENE A-E are as follows.

Menu item	SCENE A	SCENE B
TYPE	PinP	PinP
BACKGROUND CH	INPUT 1	INPUT 1
WINDOW CH	INPUT 2	INPUT 3
WINDOW POSITION H	28.5%	-28.5%
WINDOW POSITION V	28.5%	-28.5%
WINDOW ASPECT	16 : 9	16 : 9
WINDOW SIZE	30.0%	30.0%
WINDOW CROPPING H	0.0%	0.0%
WINDOW CROPPING V	0.0%	0.0%
VIEW POSITION H	0.0%	0.0%
VIEW POSITION V	0.0%	0.0%
VIEW ZOOM	100.0%	100.0%

Menu item	SCENE C	SCENE D	SCENE E
TYPE	SPLIT	SPLIT	SPLIT
PATTERN	V.CENTER	H.CENTER	V.CENTER
CENTER	50.0%	50.0%	31.6%
A CH (LEFT/UPPER)	INPUT 1	INPUT 1	INPUT 3
B CH (RIGHT/LOWER)	INPUT 2	INPUT 2	INPUT 2
A-CENTER	0.0%	0.0%	0.0%
B-CENTER	0.0%	0.0%	0.0%

(*5) The video sources assigned to INPUT 1-3 are specified by VIDEO INPUT menu → "INPUT 1"-"INPUT 3" → "INPUT SOURCE."

TRANSITION Menu

Menu item	Value (bold text: default value)	Explanation
SCENE TRANSITION	Specifies what happens when scenes are switched. * INPUT 1–3 always transition using mix.	
	BLACK FADE	A fade effect enclosing a black screen is applied. All screens switch simultaneously.
	MIX FADE	A fade effect is applied. Screens switch individually.
TIME	0.0– 1.0 –5.0sec	Specifies the transition time when switching between scenes or video.

KEY Menu

Menu item	Value (bold text: default value)	Explanation
SW	OFF , ON	Turns luminance key video compositing on/off. You can also use the [KEY] button to turn this on/off.
KEY SOURCE CH	Specifies the source of the logo or video that is overlaid when using key compositing.	
	HDMI 1–3	Video being input from the VIDEO INPUT 1–3 connectors
	STILL IMAGE 1, 2	A still image loaded into the unit
KEY COLOR	BLACK , WHITE	Specifies the key color (black or white).
KEY LEVEL	0– 32 –127	Adjusts the degree of extraction (transparency) for the key.
KEY GAIN	0– 4 –16	Adjusts the degree of edge blur (semi-transmissive region) for the key.

AUTO SWITCHING Menu

Menu item	Value (bold text: default value)	Explanation
SW	OFF , ON	Turns the auto switching function on/off. If this is "ON," the INPUT 1–3 video and scenes A–E are switched automatically. You can also use the [AUTO SW] button to turn this on/off.
TYPE	Specifies the operation mode for auto switching.	
	AUTO SCAN	Video is switched at the specified interval.
	BEAT SYNC	The beat is detected from the song (input audio), and the video is switched at the timing of the beat.
	VIDEO FOLLOWS AUDIO	Audio being input from the mic is detected, and the specified video is switched according to the volume.

When TYPE = AUTO SCAN

SEQUENCE	Specifies the order in which video signals are shown.	
	NORMAL	INPUT 1–3 → switch in the order of scenes A–E. * INPUT 1–3 are skipped if there is no video input.
	RANDOM	Switch randomly.
INPUT 1–3 DURATION	OFF, 1– 7 –120sec	Specifies the time that the video is shown. If this is "OFF," video switching does not affect the input.
SCENE A–E DURATION	OFF , 1–120sec	

When TYPE = BEAT SYNC

SYNC SOURCE	HDMI 1–3, MIC 1–2, LINE, USB FROM PC, PLAYBACK (BGM/SE)	Specifies the input audio that synchronizes the video.
CYCLE	1– 4 –10	Specifies the number of beats at which to switch to the next video.
SEQUENCE	Specifies the order in which video signals are shown.	
	NORMAL	INPUT 1–3 → switch in the order of scenes A–E. * INPUT 1–3 are skipped if there is no video input.
	RANDOM	Switch randomly.
INPUT 1–3 SW	OFF, ON	Specifies whether video switching applies (ON) or does not apply (OFF) to the source.
SCENE A–E SW	OFF , ON	

When TYPE = VIDEO FOLLOWS AUDIO

TIME	1– 2 –120sec	Specifies the time until audio detection resumes after mic audio has been detected to switch the video or scene.
MIC 1 SENSE	0– 50 –100	Specify the detection level for the audio being input to the MIC 1 or 2 jack. The higher the level, the more easily audio is detected.
MIC 2 SENSE	0– 50 –100	
MIC 1 SELECT	OFF, INPUT 1–3, SCENE A–E	Specifies the video/scene that is output when audio is detected in MIC 1.
MIC 2 SELECT	The default values are as follows.	Specifies the video/scene that is output when audio is detected in MIC 2.
MIC 1 + MIC 2 SELECT	MIC 1 SELECT: INPUT 1 MIC 2 SELECT: INPUT 2	Specifies the video/scene that is output when audio is detected in both MIC 1 and MIC 2.
	MIC 1 + MIC 2 SELECT: INPUT 3	
SILENT SELECT	SILENT SELECT: OFF	Specifies the video/scene that is output when there is no audio input in either MIC 1 or MIC 2.

ON AIR Menu

Menu item	Value (bold text: default value)	Explanation
OFF COLOR	BLACK , WHITE	Specifies the background color (black, white) used when fading-in/out the main output video.
AUDIO FADE	Specifies the operation when the [ON AIR] button is pressed.	
	OFF	Only the video fades-in/out.
	ON	The video and audio fade-in/out together.

AUDIO INPUT Menu

Menu item	Value (bold text: default value)	Explanation
MIC 1, 2	Adjusts the audio that is input from the MIC 1 and 2 jacks.	
HEAD AMP GAIN	0– 36 –64dB	Adjusts the input gain (sensitivity) in the analog domain.
DIGITAL GAIN	-42.0– 0.0 –42.0dB	Adjusts the input gain (sensitivity) in the digital domain (after conversion from analog to digital).
LEVEL	-INF– 0.0 –10.0dB	Adjusts the input volume.
MUTE	OFF , ON	Turns the mute function on/off. If this is “ON,” the audio is temporarily silenced.
SOLO	OFF , ON	Turns the solo function on/off. Only the audio for which this is “ON” is heard in the headphones. * The solo function applies to the headphone output. It does not affect output other than the headphones.
REVERB SEND	-INF– 0.0 –10.0dB	Adjusts the amount of audio sent to reverb.
AUX SEND	-INF– 0.0 –10.0dB	Adjusts the amount of audio sent to the AUX bus.
DELAY	0.0 –500.0ms (*6) (0.0 –29.9/25.0frame)	Adjusts the delay time of the audio. Effect Delays the output of the audio by the specified time.
PAN	LEFT– CENTER –RIGHT	Adjusts the stereo position (pan).
HOWLING CANCELLER	OFF , ON	Turns the howling canceller function on/off. If this is “ON,” howling (acoustic feedback) is suppressed.
DYNAMICS	(OFF, ON)	Press the [VALUE] knob to access the DYNAMICS menu.
GATE	Turns the noise gate on/off.	
	OFF , ON	Effect Eliminates audio that is lower than the specified threshold level. This is effective when the noise that you want to remove is separate from the audio that you want to keep, and can be used to remove hiss or other noise that is heard during periods of silence.
GATE THRESHOLD	-80.0– -50.0 –0.0dB	Specifies the level used as the threshold for removing audio.
GATE RELEASE	30– 860 –5000ms	Specifies the length of time until the audio is fully attenuated after audio falls below the threshold.
COMP/LMT	OFF , ON	Turns the compressor or limiter on/off.
COMP/LMT TYPE	Selects the compressor or limiter.	
	COMP1	This compressor is suitable for music. Effect Audio that exceeds the specified threshold level is compressed. This reduces the difference between the maximum volume and minimum volume, making the audio more comfortable for listening.
	COMP2	This compressor is suitable for voice. Its effect applies more quickly than “COMP1.”
COMP/LMT THRESHOLD	LIMITER	This is a limiter. Effect Audio that exceeds the specified threshold level is compressed. This prevents distortion from occurring when unexpectedly loud audio is input. * Distortion will occur if audio that exceeds the allowable range of the limiter is input.
	-80.0– -50.0 –0.0dB	Specifies the threshold at which the compressor/limiter applies.
EQ	(OFF, ON)	Press the [VALUE] knob to access the EQ (equalizer) menu.
SW	OFF , ON	Turns the equalizer on/off. Effect Adjusts the tone quality for each frequency band.
HI	-15.0– 0.0 –15.0dB	Boosts or attenuates the high band.
HI FREQ	1.00– 10.0 –20.0kHz	Adjusts the center frequency when changing the tone quality in the high band.
MID	-15.0– 0.0 –15.0dB	Boosts or attenuates the middle band.
MID FREQ	20.0Hz– 500Hz –20.0kHz	Adjusts the center frequency when changing the tone quality in the middle band.
MID Q	0.5– 1.0 –16.0	Adjusts the width of the frequency band when boosting or attenuating the middle band.
LO	-15.0– 0.0 –15.0dB	Boosts or attenuates the low band.
LO FREQ	20.0– 100 –500Hz	Adjusts the center frequency when changing the tone quality in the low band.

(*6) The number of frames shown in parentheses differs depending on the SYSTEM menu's “FRAME RATE” setting.

Menu item	Value (bold text: default value)	Explanation
HPF 75Hz	OFF , ON	Turns the high-pass filter on/off. Effect Cuts off unneeded low-band audio. The cutoff frequency is 75 Hz.
LOAD PRESET	Press the [VALUE] knob to see a preset list for the effects (high-pass filter, equalizer). When you select a preset, the settings of each effect are overwritten.	
	DEFAULT	Flat settings that do not apply any effect.
	WIND NR	Reduces wind noise.
	VIBRATION NR	Reduces vibration and other low-frequency noise.
	LIP NR	Reduces noises produced by the lips when speaking or singing. This is appropriate for vocal input.
	SPEECH	Makes a spoken voice easier to understand.
	VOCAL	Enhances a singing voice.
PHANTOM +48V	(OFF, ON)	Indicates the on/off status of the [PHANTOM] switch.
LINE	Adjusts the audio that is input from the LINE IN jacks.	
DIGITAL GAIN	-42.0- 0.0 -42.0dB	Adjusts the input gain (sensitivity).
LEVEL	-INF- 0.0 -10.0dB	Adjusts the input volume.
MUTE	OFF , ON	Turns the mute function on/off. If this is "ON," the audio is temporarily silenced.
SOLO	OFF , ON	Turns the solo function on/off. Only the audio for which this is "ON" is heard in the headphones. * The solo function applies to the headphone output. It does not affect output other than the headphones.
REVERB SEND	-INF- 0.0 -10.0dB	Adjusts the amount of audio sent to reverb.
AUX SEND	-INF- 0.0 -10.0dB	Adjusts the amount of audio sent to the AUX bus.
DELAY	0.0 -500.0ms (*7) (0.0 -29.9/25.0frame)	Adjusts the delay time of the audio. Effect Delays the output of the audio by the specified time.
EQ	(OFF, ON)	Press the [VALUE] knob to access the EQ (equalizer) menu.
SW	OFF , ON	Turns the equalizer on/off. Effect Adjusts the tone quality for each frequency band.
HI	-15.0- 0.0 -15.0dB	Boosts or attenuates the high band.
HI FREQ	1.00- 10.0 -20.0kHz	Adjusts the center frequency when changing the tone quality in the high band.
MID	-15.0- 0.0 -15.0dB	Boosts or attenuates the middle band.
MID FREQ	20.0Hz- 500Hz -20.0kHz	Adjusts the center frequency when changing the tone quality in the middle band.
MID Q	0.5- 1.0 -16.0	Adjusts the width of the frequency band when boosting or attenuating the middle band.
LO	-15.0- 0.0 -15.0dB	Boosts or attenuates the low band.
LO FREQ	20.0- 100 -500Hz	Adjusts the center frequency when changing the tone quality in the low band.
HDMI 1-3	Adjusts the audio that is input from the VIDEO INPUT 1-3 connectors.	
DIGITAL GAIN	-42.0- 0.0 -42.0dB	Adjusts the input gain (sensitivity).
LEVEL	-INF- 0.0 -10.0dB	Adjusts the input volume.
MUTE	OFF , ON	Turns the mute function on/off. If this is "ON," the audio is temporarily silenced.
SOLO	OFF , ON	Turns the solo function on/off. Only the audio for which this is "ON" is heard in the headphones. * The solo function applies to the headphone output. It does not affect output other than the headphones.
REVERB SEND	-INF- 0.0 -10.0dB	Adjusts the amount of audio sent to reverb.
AUX SEND	-INF- 0.0 -10.0dB	Adjusts the amount of audio sent to the AUX bus.
DELAY	0.0 -500.0ms (0.0 -29.9/25.0frame)	Adjusts the delay time of the audio. Effect Delays the output of the audio by the specified time.
EQ	(OFF, ON)	Press the [VALUE] knob to access the EQ (equalizer) menu.
SW	OFF , ON	Turns the equalizer on/off. Effect Adjusts the tone quality for each frequency band.
HI	-15.0- 0.0 -15.0dB	Boosts or attenuates the high band.
HI FREQ	1.00- 10.0 -20.0kHz	Adjusts the center frequency when changing the tone quality in the high band.
MID	-15.0- 0.0 -15.0dB	Boosts or attenuates the middle band.
MID FREQ	20.0Hz- 500Hz -20.0kHz	Adjusts the center frequency when changing the tone quality in the middle band.
MID Q	0.5- 1.0 -16.0	Adjusts the width of the frequency band when boosting or attenuating the middle band.
LO	-15.0- 0.0 -15.0dB	Boosts or attenuates the low band.
LO FREQ	20.0- 100 -500Hz	Adjusts the center frequency when changing the tone quality in the low band.

(*7) The number of frames shown in parentheses differs depending on the SYSTEM menu's "FRAME RATE" setting.

USB FROM PC	Adjusts the audio that is input from the USB STREAM port.	
DIGITAL GAIN	-42.0– 0.0 –42.0dB	Adjusts the input gain (sensitivity).
LEVEL	-INF– 0.0 –10.0dB	Adjusts the input volume.
MUTE	OFF , ON	Turns the mute function on/off. If this is “ON,” the audio is temporarily silenced.
SOLO	OFF , ON	Turns the solo function on/off. Only the audio for which this is “ON” is heard in the headphones. * The solo function applies to the headphone output. It does not affect output other than the headphones.
REVERB SEND	-INF– 0.0 –10.0dB	Adjusts the amount of audio sent to reverb.
AUX SEND	-INF– 0.0 –10.0dB	Adjusts the amount of audio sent to the AUX bus.
DELAY	0.0 –500.0ms (*8) (0.0 –29.9/25.0frame)	Adjusts the delay time of the audio. Effect Delays the output of the audio by the specified time.
EQ	(OFF, ON)	Press the [VALUE] knob to access the EQ (equalizer) menu.
SW	OFF , ON	Turns the equalizer on/off. Effect Adjusts the tone quality for each frequency band.
HI	-15.0– 0.0 –15.0dB	Boosts or attenuates the high band.
HI FREQ	1.00– 10.0 –20.0kHz	Adjusts the center frequency when changing the tone quality in the high band.
MID	-15.0– 0.0 –15.0dB	Boosts or attenuates the middle band.
MID FREQ	20.0Hz– 500Hz –20.0kHz	Adjusts the center frequency when changing the tone quality in the middle band.
MID Q	0.5– 1.0 –16.0	Adjusts the width of the frequency band when boosting or attenuating the middle band.
LO	-15.0– 0.0 –15.0dB	Boosts or attenuates the low band.
LO FREQ	20.0– 100 –500Hz	Adjusts the center frequency when changing the tone quality in the low band.
PLAYBACK (BGM/SE)	Adjust the audio of the music file (background music or sound effects) that is being played.	
DIGITAL GAIN	-42.0– -12.0 –42.0dB	Adjusts the input gain (sensitivity).
LEVEL	-INF– 0.0 –10.0dB	Adjusts the input volume.
MUTE	OFF , ON	Turns the mute function on/off. If this is “ON,” the audio is temporarily silenced.
SOLO	OFF , ON	Turns the solo function on/off. Only the audio for which this is “ON” is heard in the headphones. * The solo function applies to the headphone output. It does not affect output other than the headphones.
REVERB SEND	-INF– 0.0 –10.0dB	Adjusts the amount of audio sent to reverb.
AUX SEND	-INF– 0.0 –10.0dB	Adjusts the amount of audio sent to the AUX bus.
EQ	(OFF, ON)	Press the [VALUE] knob to access the EQ (equalizer) menu.
SW	OFF , ON	Turns the equalizer on/off. Effect Adjusts the tone quality for each frequency band.
HI	-15.0– 0.0 –15.0dB	Boosts or attenuates the high band.
HI FREQ	1.00– 10.0 –20.0kHz	Adjusts the center frequency when changing the tone quality in the high band.
MID	-15.0– 0.0 –15.0dB	Boosts or attenuates the middle band.
MID FREQ	20.0Hz– 500Hz –20.0kHz	Adjusts the center frequency when changing the tone quality in the middle band.
MID Q	0.5– 1.0 –16.0	Adjusts the width of the frequency band when boosting or attenuating the middle band.
LO	-15.0– 0.0 –15.0dB	Boosts or attenuates the low band.
LO FREQ	20.0– 100 –500Hz	Adjusts the center frequency when changing the tone quality in the low band.

(*8) The number of frames shown in parentheses differs depending on the SYSTEM menu’s “FRAME RATE” setting.

AUDIO OUTPUT Menu

Menu item	Value (bold text: default value)	Explanation
BUS SELECT	Specifies the bus that is assigned to each connector.	
MONITOR	MAIN , AUX	If you specify "MAIN" (main bus), all input audio is mixed and output. This is the same audio as the main output.
USB STREAM	MAIN , AUX	If you specify "AUX" (AUX bus), only the input audio sent to the AUX bus is mixed and output. This allows you to output audio that is different than the main output.
LINE OUT	MAIN , AUX	What is a bus? A "bus" is a destination to which input audio is mixed and sent. The VR-1HD has two buses: the "main bus" and the "AUX bus." With the exception of the MAIN connector, you can assign a desired bus to each output connector.
PHONES	MAIN , AUX	
MAIN BUS	Adjusts the audio of the MAIN bus.	
LEVEL	-INF- 0.0 -10.0dB	Adjusts the output volume.
MUTE	OFF , ON	Turns the mute function on/off. If this is "ON," the audio is temporarily silenced.
LIMITER	OFF , ON	Turns the limiter on/off.
		Effect Compresses the audio so that the mixed audio does not exceed the specified threshold level. * Distortion will occur if audio that exceeds the allowable range of the limiter is input.
LIMITER THRESHOLD	-40.0-- 6.0 -0.0dB	Specifies the threshold at which the limiter applies.
EQ	(OFF, ON)	Press the [VALUE] knob to access the EQ (equalizer) menu.
SW	OFF , ON	Turns the equalizer on/off.
HI	-15.0- 0.0 -15.0dB	Boosts or attenuates the high band.
HI FREQ	1.00- 10.0 -20.0kHz	Adjusts the center frequency when changing the tone quality in the high band.
MID	-15.0- 0.0 -15.0dB	Boosts or attenuates the middle band.
MID FREQ	20.0Hz- 500Hz -20.0kHz	Adjusts the center frequency when changing the tone quality in the middle band.
MID Q	0.5- 1.0 -16.0	Adjusts the width of the frequency band when boosting or attenuating the middle band.
LO	-15.0- 0.0 -15.0dB	Boosts or attenuates the low band.
LO FREQ	20.0- 100 -500Hz	Adjusts the center frequency when changing the tone quality in the low band.
AUX BUS	Adjusts the audio of the AUX bus.	
LEVEL	-INF-10.0dB	Adjusts the output volume.
MUTE	OFF , ON	Turns the mute function on/off. If this is "ON," the audio is temporarily silenced.
LIMITER	OFF , ON	Turns the limiter on/off.
		Effect Compresses the audio so that the mixed audio does not exceed the specified threshold level. * Distortion will occur if audio that exceeds the allowable range of the limiter is input.
LIMITER THRESHOLD	-40.0-- 6.0 -0.0dB	Specifies the threshold at which the limiter applies.
DELAY	0.0 -500.0ms (*9) (0.0 -29.9/25.0frame)	Adjusts the delay time of the audio.
EQ	(OFF, ON)	Press the [VALUE] knob to access the EQ (equalizer) menu.
SW	OFF , ON	Turns the equalizer on/off.
HI	-15.0- 0.0 -15.0dB	Boosts or attenuates the high band.
HI FREQ	1.00- 10.0 -20.0kHz	Adjusts the center frequency when changing the tone quality in the high band.
MID	-15.0- 0.0 -15.0dB	Boosts or attenuates the middle band.
MID FREQ	20.0Hz- 500Hz -20.0kHz	Adjusts the center frequency when changing the tone quality in the middle band.
MID Q	0.5- 1.0 -16.0	Adjusts the width of the frequency band when boosting or attenuating the middle band.
LO	-15.0- 0.0 -15.0dB	Boosts or attenuates the low band.
LO FREQ	20.0- 100 -500Hz	Adjusts the center frequency when changing the tone quality in the low band.
USB STREAM	Adjusts the audio that is output from the USB STREAM port.	
LEVEL	-INF-10.0dB	Adjusts the output volume.
MUTE	OFF , ON	Turns the mute function on/off. If this is "ON," the audio is temporarily silenced.
DELAY	0.0 -500.0ms (*10) (0.0 -14.9/29.9/12.0/25.0frame)	Adjusts the delay time of the audio.
		Effect Delays the output of the audio by the specified time.

(*9) The number of frames shown in parentheses differs depending on the SYSTEM menu's "FRAME RATE" setting.

(*10) The number of frames in parentheses differs depending on the VIDEO OUTPUT menu's "USB FORMAT" setting.

AUDIO FOLLOWS VIDEO Menu

Menu item	Value (bold text: default value)	Explanation
HDMI 1–3 SW		Turns the audio follow function on/off. Audio follow is a function that automatically switches the audio output in tandem with video switching.
	OFF	The audio is always output regardless of the input video selection.
	ON	The video and audio from HDMI input are switched together.
MIC 1 SW	OFF , INPUT 1–3	For each audio source, these settings specify the input video (INPUT 1–3) that will use the audio follow function. Audio is output only when the specified input video is selected. If this is “OFF,” the audio is always output regardless of the input video selection.
MIC 2 SW	OFF , INPUT 1–3	
LINE SW	OFF , INPUT 1–3	
USB FROM PC SW	OFF , INPUT 1–3	
PLAYBACK (BGM/SE) SW	OFF , INPUT 1–3	

AUTO MIXING Menu

Menu item	Value (bold text: default value)	Explanation
SW	OFF , ON	Turns the auto mixing function on/off. Auto mixing is a function that automatically controls the volume adjustments.
MIC 1 SW	OFF, ON	Specifies whether Auto Mixing is applied (ON) or not applied (OFF).
MIC 2 SW	OFF, ON	
LINE SW	OFF , ON	
HDMI 1 SW	OFF , ON	
HDMI 2 SW	OFF , ON	
HDMI 3 SW	OFF , ON	
USB FROM PC SW	OFF , ON	

ECHO CANCELLER Menu

Menu item	Value (bold text: default value)	Explanation
MIC 1 SW	OFF , ON	Turns the echo canceller function on/off. Echo canceller is a function that suppresses the voice echo that can occur when using a web conferencing system that includes a speaker and mic.
MIC 2 SW	OFF , ON	If this is “ON,” the echo component of the voice picked up by a mic connected to the VR-1HD is suppressed, so that only your own voice is sent to the other party.
MIC 1 DEPTH	1– 5 –10	Adjusts the depth of the echo canceller.
MIC 2 DEPTH	1– 5 –10	

AUDIO EFFECTS Menu

Menu item	Value (bold text: default value)	Explanation	
EFFECTS 1–4 (*11)	These settings assign functions to the AUDIO EFFECTS [1]–[4] buttons and specify details of their operation.		
ASSIGN	Specifies the function that is assigned to the AUDIO EFFECTS [1]–[4] button.		
	NONE	No function is assigned.	
	VOICE CHANGER	Turns the voice changer on/off. Effect Transforms the pitch or character of the voice that is input from the mic.	
	PLAYBACK (BGM/SE)	Plays/stops the music file (background music or sound effect).	
	REVERB	Turns reverb on/off. Effect Adds reverberation to the sound.	
	MUTE	Turns the mute function on/off for the audio.	
SOLO	Turns the solo function on/off for the input audio.		
When ASSIGN = VOICE CHANGER			
SW	OFF , ON	Turns the voice changer on/off. You can also turn this on/off using the AUDIO EFFECTS button to which the function is assigned.	
SW MODE	Specifies the operation of the AUDIO EFFECTS button.		
	MOMENTARY	The effect is on only while you hold down the button, and turns off when you release the button.	
	LATCH	The effect alternately turns on/off each time you press the button.	
TARGET	MIC 1 , MIC 2	Specifies the mic audio to which the effect applies.	
PITCH	-12– +12	Adjusts the pitch of the voice in semitone steps. A setting of “0” is the original pitch.	
FORMANT	-10– +4 – +10	Adjusts the character (formant) of the voice. Settings in the negative (–) direction produce a more masculine vocal character, and settings in the positive (+) direction produce a more feminine vocal character. A setting of “0” is the original voice.	
ROBOT	OFF , ON	If this is “ON,” the voice is held at a fixed pitch, creating a mechanical robot-like impression.	
MIX	0– 100	Adjusts the balance between the unprocessed voice (0) and the voice processed by the effect (100).	
LED COLOR	RED, GREEN, YELLOW, BLUE, MAGENTA, CYAN	Specifies the illumination color of the AUDIO EFFECTS button.	
When ASSIGN = PLAYBACK (BGM/SE)			
SW	OFF , ON	Plays/stops the background music or sound effect.	
SW MODE	Specifies the operation of the AUDIO EFFECTS button.		
	MOMENTARY	The effect is on only while you hold down the button, and turns off when you release the button.	
	LATCH	The effect alternately turns on/off each time you press the button.	
AUDIO ASSIGN	Selects the music file that will play. Press the [VALUE] knob to see a list of clips.		
	BriskAfternoon	Sample clip of background music.	
	Applause	Sample clip of sound effect (applause).	
	USB MEMORY	Use a music file saved on the USB flash drive. Press the [VALUE] knob to view a list of the music files saved in the root directory of the USB flash drive.	
		Music files that can be played	
		Format (extension)	WAV (.wav)
		Sample rate	44.1, 48 kHz
		Bit depth	16 bits
		Number of channels	Stereo, mono
		File size	2 GB or less
File name	Up to eight single-byte alphanumeric characters * The extension “wav” must be added.		
	* Music files shorter than 10 ms might not play correctly. * The VR-1HD plays back the music file directly from the connected USB flash drive. Even if a music file on the USB flash drive is selected, it will not play unless the USB flash drive is connected.		
LEVEL	-INF–10.0dB	Adjusts the playback volume of the music file.	
LOOP	OFF, ON	Turns loop playback on/off.	
FADE IN	OFF, 0.1–10.0sec	Specifies the fade-in time of the music file.	
FADE OUT	OFF, 0.1–10.0sec	Specifies the fade-out time of the music file.	
LED COLOR	RED, GREEN, YELLOW, BLUE, MAGENTA, CYAN	Specifies the illumination color of the AUDIO EFFECTS button.	

Menu item	Value (bold text: default value)	Explanation
When ASSIGN = REVERB		
SW	OFF, ON	Turns reverb on/off. You can also turn this on/off using the AUDIO EFFECTS button to which the function is assigned.
SW MODE	Specifies the operation of the AUDIO EFFECTS button.	
	MOMENTARY	The effect is on only while you hold down the button, and turns off when you release the button.
	LATCH	The effect alternately turns on/off each time you press the button.
LEVEL	-INF- -20.0 -10.0dB	Sets the amount of sound that is returned from the reverb (return level). This adjusts the depth of the overall reverb.
TIME	0.0- 0.5 -5.0sec	Specifies the time until the reverberation is no longer heard.
TYPE	Specifies the reverb type.	
	ROOM	Produces the natural-sounding reverberation of a room.
	HALL	Produces the reverberation that is typical of a performance in a concert hall.
LED COLOR	RED, GREEN, YELLOW, BLUE, MAGENTA, CYAN	Specifies the illumination color of the AUDIO EFFECTS button.
When ASSIGN = MUTE		
SW	OFF , ON	Turns the mute function on/off for the audio specified by "CH." You can also turn this on/off using the AUDIO EFFECTS button to which the function is assigned.
SW MODE	Specifies the operation of the AUDIO EFFECTS button.	
	MOMENTARY	The effect is on only while you hold down the button, and turns off when you release the button.
	LATCH	The effect alternately turns on/off each time you press the button.
CH	HDMI 1-3, MIC 1 -2, LINE, USB FROM PC, USB STREAM, AUX, MAIN	Specify the audio that will be affected by the operation.
LED COLOR	RED, GREEN, YELLOW, BLUE, MAGENTA, CYAN	Specifies the illumination color of the AUDIO EFFECTS button.
When ASSIGN = SOLO		
SW	OFF , ON	Turns the solo function on/off for the audio specified by "CH." You can also turn this on/off using the AUDIO EFFECTS button to which the function is assigned.
SW MODE	Specifies the operation of the AUDIO EFFECTS button.	
	MOMENTARY	The effect is on only while you hold down the button, and turns off when you release the button.
	LATCH	The effect alternately turns on/off each time you press the button.
CH	HDMI 1-3, MIC 1 -2, LINE, USB FROM PC	Specify the audio that will be affected by the operation.
LED COLOR	RED, GREEN, YELLOW, BLUE, MAGENTA, CYAN	Specifies the illumination color of the AUDIO EFFECTS button.

(*11) The factory settings for EFFECTS 1-4 are as follows.

Menu item	EFFECTS 1
ASSIGN	VOICE CHANGER
SW	OFF
SW MODE	LATCH
TARGET	MIC 1
PITCH	+12
FORMANT	+4
ROBOT	OFF
MIX	100
LED COLOR	MAGENTA

Menu item	EFFECTS 2
ASSIGN	PLAYBACK (BGM/SE)
SW	OFF
SW MODE	LATCH
AUDIO ASSIGN	BriskAfternoon
LEVEL	0.0dB
LOOP	ON
FADE IN	OFF
FADE OUT	3.0sec
LED COLOR	CYAN

Menu item	EFFECTS 3
ASSIGN	PLAYBACK (BGM/SE)
SW	OFF
SW MODE	LATCH
AUDIO ASSIGN	Applause
LEVEL	0.0dB
LOOP	OFF
FADE IN	OFF
FADE OUT	1.0sec
LED COLOR	BLUE

Menu item	EFFECTS 4
ASSIGN	REVERB
SW	OFF
SW MODE	LATCH
LEVEL	-20.0dB
TIME	0.5sec
TYPE	ROOM
LED COLOR	YELLOW

USB MEMORY Menu								
Menu item	Value (bold text: default value)	Explanation						
LOAD SETTINGS	[EXEC]	Shows a list of the setting files (.VR1) that are on the USB flash drive. You can select a setting file and load the settings into the unit. The current settings are overwritten.						
SAVE SETTINGS	[EXEC]	Shows a list of the setting files (.VR1) that are on the USB flash drive. You can select a setting file and then save the current settings by overwriting them onto the selected file.						
SAVE SETTINGS AS	[EXEC]	<p>Saves the current settings to the USB flash drive as a new file. A file name of "SYS + four-digit consecutive number.VR1" is assigned as the file name.</p> <p>Content that is not saved to the file</p> <ul style="list-style-type: none"> • The SYSTEM menu settings "TEST PATTERN" and "TEST TONE." The unit always starts with these "OFF." • The still images loaded into the unit. Only the file names of the still images are saved. • The state of the [ON AIR] button. The unit always starts with this lit. • The state of an AUDIO EFFECTS button to which "PLAYBACK (BGM/SE)" is assigned. The unit always starts with this off. • The positions of the volume knobs and faders. 						
LOAD STILL IMAGE	1, 2	<p>Specifies the loading destination for the still image (internal memory 1 or 2). When you press the [VALUE] knob, a list of the still images saved in the root directory of the USB flash drive is shown. You can select a still image and load it into the unit.</p> <p>Formats supported for loading</p> <table border="1"> <tbody> <tr> <td>Format</td> <td>Windows Bitmap File (.bmp), 24-bit color, uncompressed</td> </tr> <tr> <td>Resolution</td> <td>Maximum 1920 x 1200 pixels</td> </tr> <tr> <td>File name</td> <td>Up to eight single-byte alphanumeric characters * The extension ".bmp" must be added.</td> </tr> </tbody> </table> <p>* The still image is temporarily saved in internal memory. When you turn off the power, the still image is deleted. * An internal memory in which a still image is loaded is indicated by a " * " symbol. * You can make the previously-loaded still image be automatically loaded when the VR-1HD starts. Save the same file in the root directory of the USB flash drive, and start the VR-1HD with the USB flash drive connected.</p>	Format	Windows Bitmap File (.bmp), 24-bit color, uncompressed	Resolution	Maximum 1920 x 1200 pixels	File name	Up to eight single-byte alphanumeric characters * The extension ".bmp" must be added.
Format	Windows Bitmap File (.bmp), 24-bit color, uncompressed							
Resolution	Maximum 1920 x 1200 pixels							
File name	Up to eight single-byte alphanumeric characters * The extension ".bmp" must be added.							
FORMAT	[EXEC]	Formats the USB flash drive.						

SYSTEM Menu

Menu item	Value (bold text: default value)	Explanation	
HDCP	OFF , ON	Specifies whether HDCP is enabled (ON) or disabled (OFF). When set to "ON," copyright-protected (HDCP) video can be input. HDCP is also added to the video that is output. * If this is "ON," video/audio is not output from the USB STREAM port.	
FRAME RATE	59.94 , 50Hz	Specifies the frame rate. * When you change the setting, the change is not applied until you press the [VALUE] knob to confirm.	
TEST PATTERN	OFF , 75% COLOR BAR, 100% COLOR BAR, RAMP, STEP, HATCH	Specifies the test pattern.	
TEST TONE	OFF , -20dB, -10dB, 0dB, 0dB-L, 0dB-R	Specifies the test tone. If this is set to "0dB-L" or "0dB-R," a test tone is output from the left channel (L) or right channel (R) respectively.	
PANEL LOCK	[ENTER]	Displays the PANEL LOCK menu.	
	Specify what panel lock will affect (ON) or will not affect (OFF).		
	Menu item	Value (bold text: default value)	Explanation
	ALL	OFF , ON	The settings of the following buttons and knobs are turned on/off together.
	MENU	OFF , ON	[MENU] button
	VALUE	OFF , ON	[VALUE] knob
	INPUT SELECT	OFF , ON	INPUT [1]–[3] button
	SCENE EDIT	OFF , ON	[SCENE EDIT] button
	SCENE SELECT	OFF , ON	SCENE [A]–[E] button
	AUTO SW	OFF , ON	[AUTO SW] button
	ON AIR	OFF , ON	[ON AIR] button
	KEY	OFF , ON	[KEY] button
	AUDIO EFFECTS	OFF , ON	AUDIO EFFECTS [1]–[4] button
	MIC 1 FADER	OFF , ON	[MIC 1] fader
	MIC 2 FADER	OFF , ON	[MIC 2] fader
	LINE IN FADER	OFF , ON	[LINE] fader
	MAIN VOLUME	OFF , ON	[MAIN] knob
USB STREAM VOLUME	OFF , ON	[USB STREAM] knob	
PHONES VOLUME	OFF , ON	[PHONES] knob	
LEVEL SETUP	OFF , ON	[LEVEL SETUP] button	
Locking/unlocking the operation panel			
When you simultaneously hold down the [MENU] button and [SCENE EDIT] button for three seconds or longer, the operation panel is locked or unlocked (p. 27).			
LED DIMMER	0–7	Adjusts the brightness when the buttons or indicators are lit. * Even with a setting of "0," the buttons and indicators do not go completely dark.	
AUTO INPUT DETECT	OFF, ON	Turns the auto input detect function on/off. If this is "ON," the input is automatically detected when the video input currently being output is interrupted, and the video is switched. * If a scene is selected, the auto input detect function is disabled.	
DELETE STILL IMAGE	1, 2	Selects the internal memory whose still image will be deleted. Press the [VALUE] knob to delete the loaded still image. * A "*" symbol is shown for an internal memory in which a still image is loaded.	
AUTO POWER OFF	OFF , ON	Turns the Auto Off function on/off. If this is "ON," the power to the VR-1HD turns off automatically when all of the following states persist for 240 minutes. <ul style="list-style-type: none"> No operation performed on the VR-1HD No audio or video input No equipment is connected to the MAIN/MONITOR (MENU)/THRU connectors 	
FACTORY RESET	[EXEC]	Returns the unit to its factory defaults.	
VERSION	—	Displays the version of the system program.	

LEVEL SETUP Menu		Press the [LEVEL SETUP] button to access this menu.
Menu item	Value (bold text: default value)	Explanation
LEVEL SETUP (LEVEL) (1/5)		Adjusts the volume.
HDMI 1	-INF- 0.0 -10.0dB	VIDEO INPUT 1-3 input
HDMI 2	-INF- 0.0 -10.0dB	
HDMI 3	-INF- 0.0 -10.0dB	
USB FROM PC	-INF- 0.0 -10.0dB	USB input
PLAYBACK (BGM/SE)	-INF- 0.0 -10.0dB	Music files (p. 23)
AUX BUS	-INF- 0.0 -10.0dB	AUX bus
LEVEL SETUP (GAIN) (2/5)		Adjusts the head amp gain (the input gain in the analog domain).
MIC 1	0- 36 -64dB	MIC 1, 2 input
MIC 2	0- 36 -64dB	
LEVEL SETUP (SOLO) (3/5)		Turns the solo function on/off. Only the audio for which this is "ON" is heard in the headphones.
MIC 1	OFF , ON	MIC 1, 2 input
MIC 2	OFF , ON	
LINE	OFF , ON	LINE input
HDMI 1	OFF , ON	VIDEO INPUT 1-3 input
HDMI 2	OFF , ON	
HDMI 3	OFF , ON	
USB FROM PC	OFF , ON	USB input
PLAYBACK (BGM/SE)	OFF , ON	Music files (p. 23)
LEVEL SETUP (MUTE) (4/5-5/5)		Turns the mute function on/off. If this is "ON," the audio is temporarily silenced.
MIC 1	OFF , ON	MIC 1, 2 input
MIC 2	OFF , ON	
LINE	OFF , ON	LINE input
HDMI 1	OFF , ON	VIDEO INPUT 1-3 input
HDMI 2	OFF , ON	
HDMI 3	OFF , ON	
USB FROM PC	OFF , ON	USB input
PLAYBACK (BGM/SE)	OFF , ON	Music files (p. 23)
MAIN BUS	OFF , ON	Main bus
AUX BUS	OFF , ON	AUX bus
USB STREAM	OFF , ON	USB output

* The LEVEL SETUP menu provides certain functions (volume, input gain, solo, mute) that have been excerpted from the AUDIO INPUT and OUTPUT menus.

Appendices

Troubleshooting

If you suspect a malfunction, please check the following points. If this does not resolve the problem, contact a nearby Roland Service Center.

Problem	Items to check	Action	Page
Video-related problems			
No picture is input.	Could you be inputting copy-protected (HDCP) video?	If you want to input copy-protected (HDCP) video, set the System menu "HDCP" setting to "ON."	p. 9
Video input from a computer is distorted.	If video is being input from a computer, the image can sometimes be skewed, flickering, or otherwise distorted.	This is a phenomenon called "tearing," and is not a malfunction.	—
No video appears.	Could the [ON AIR] button be unlit?	If the [ON AIR] button is unlit, the main output video fades-out to a black screen. To output the main video, press the [ON AIR] button to make it light.	p. 14
	Could "HDCP" be "ON"?	If the SYSTEM menu item "HDCP" is "ON," video and audio are not output from the USB STREAM port.	p. 9
	Does the output destination display support copy protection (HDCP)?	If you are outputting copy-protected (HDCP) video, and a display that does not support HDCP is connected, the video might not be shown or might be incorrect. Connect a display that supports HDCP.	p. 9
"Snowy"-noise video is shown.	It might be that the HDMI signal is not being correctly transmitted or received.	Reconnect the HDMI cable.	—
Color is wrong.	Do the color space settings of the output-destination device and the VR-1HD match?	Change the color space in VIDEO OUTPUT menu → "MAIN OUTPUT," "MONITOR (MENU) OUTPUT" → "COLOR SPACE"	p. 8
		Depending on the device, the color space might be linked with the DVI/HDMI selection or the selection of format. If so, changing the color space of the output-destination device might solve the problem.	—
An edge of the video shown on a display is cut off.	Are the display's settings correct?	Depending on the display, it might overscan automatically. Change the settings of the device.	—
Can't connect via USB 3.0. Video is jerky.	Could you be connecting via an extension cable or a USB hub?	If you connect via an extension cable or a USB hub, the computer might not recognize the VR-1HD. We recommend that you connect the VR-1HD directly to your computer.	—
	—	Go to the VIDEO OUTPUT menu → "USB STREAM" → execute "CONNECTION RESET" to try reconnecting the computer and the VR-1HD.	—
	Could you be using a USB 2.0 cable to connect the VR-1HD and the computer?	If you're outputting HD video via USB, use a USB 3.0 cable to connect the VR-1HD and the computer.	—
Can't load a still image.	Could the still image be a format or resolution that the VR-1HD does not support?	A still image of an unsupported format or resolution is not detected. Check the formats and resolutions that can be loaded.	p. 15
	Is the file name of the still image assigned correctly?	If the file's name is not correct, it is not recognized. The file name must be no more than eight single-byte characters. Also, the file name extension ".bmp" must be added.	
Audio-related problems			
No audio is output. Audio volume is low.	Is the volume turned down on the VR-1HD?	Adjust each input to the appropriate volume. Also raise the output volume.	p. 16
	Could the volume of the USB output be lowered?	The USB output volume (the volume for streaming) can be adjusted individually. Use the [USB STREAM] knob to adjust the main output volume.	p. 21
	Could the sound be muted (silenced)?	Cancel muting for the input/output audio.	p. 21
	Is there audio for which the solo function is turned on?	Only the soloed audio is heard from the headphones. Cancel the solo function.	p. 21
	Is a condenser mic connected?	If a condenser mic or other device requiring a phantom power supply is connected, turn the [PHANTOM] switch on.	p. 5
Can't play back or load a music file.	Is a USB flash drive containing music files connected?	The VR-1HD plays back music files directly from the connected USB flash drive. If you want to play back a music file that is on a USB flash drive, you must connect that USB flash drive.	p. 23
	Is the file name of the music file assigned correctly?	If the file's name is not correct, it is not recognized. The file name must be no more than eight single-byte characters. Also, the file name extension ".wav" must be added.	
Other Problems			
Can't use a USB flash drive.	Has the USB flash drive been formatted by the VR-1HD?	A USB flash drive that was not formatted by the VR-1HD is not recognized. When using a USB flash drive for the first time, you must format it on the VR-1HD.	p. 27

Block Diagram

Video section

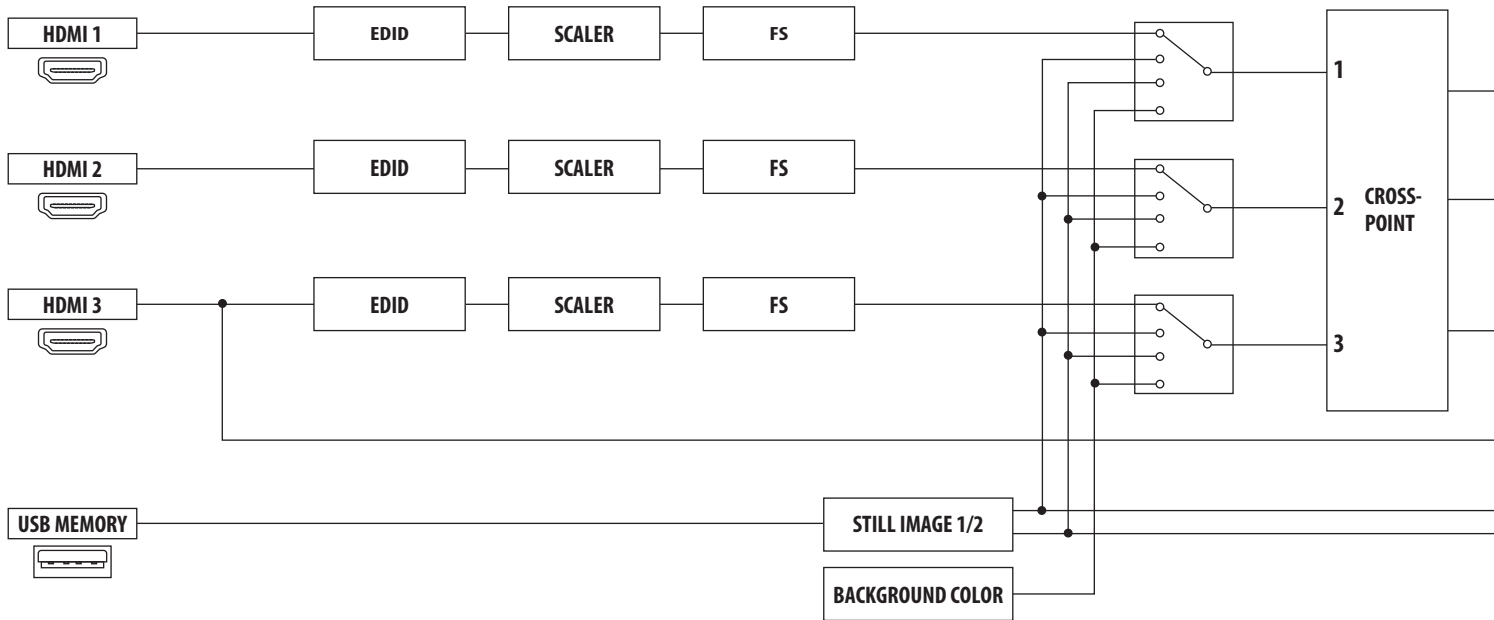

Audio section

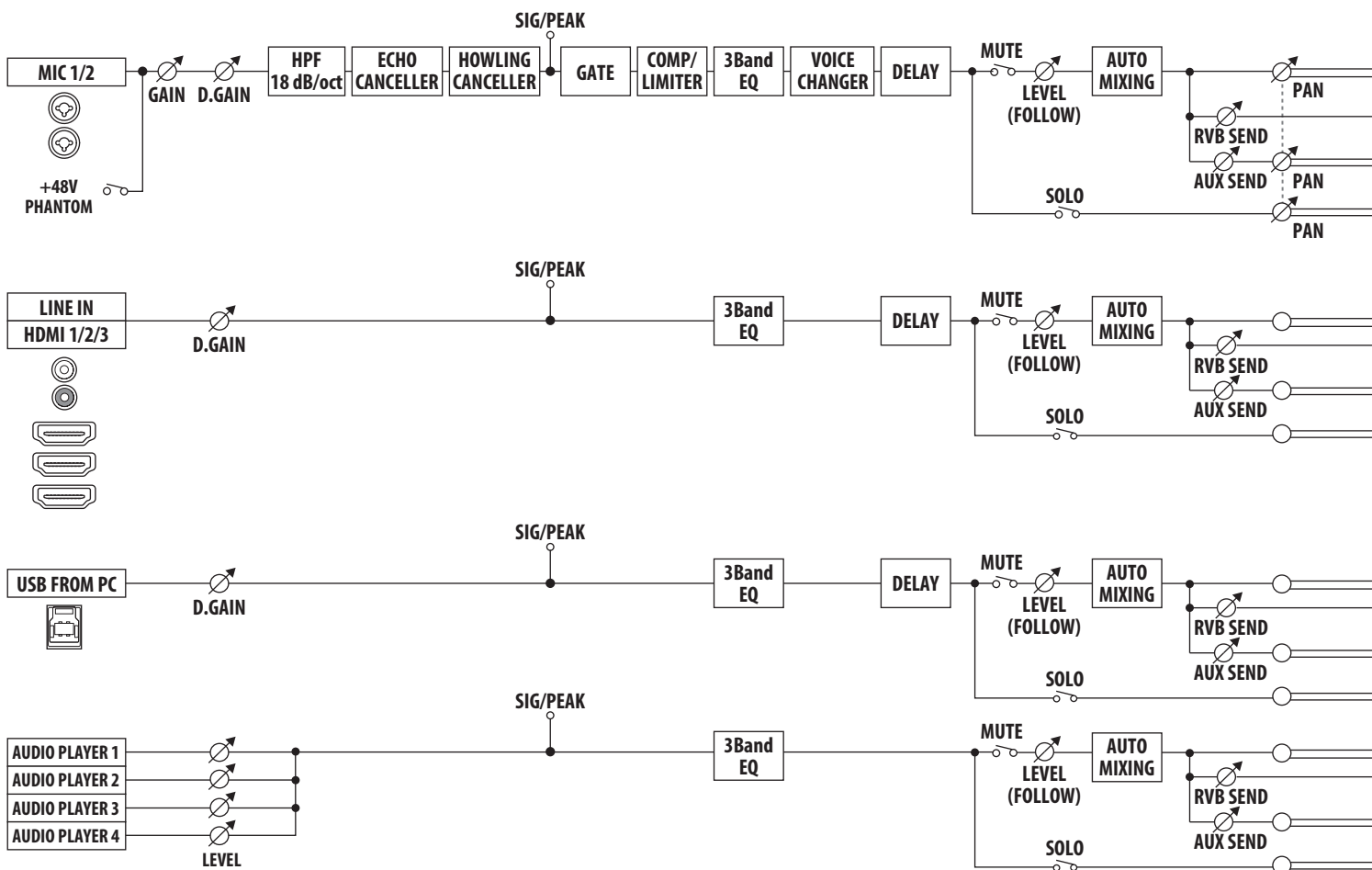

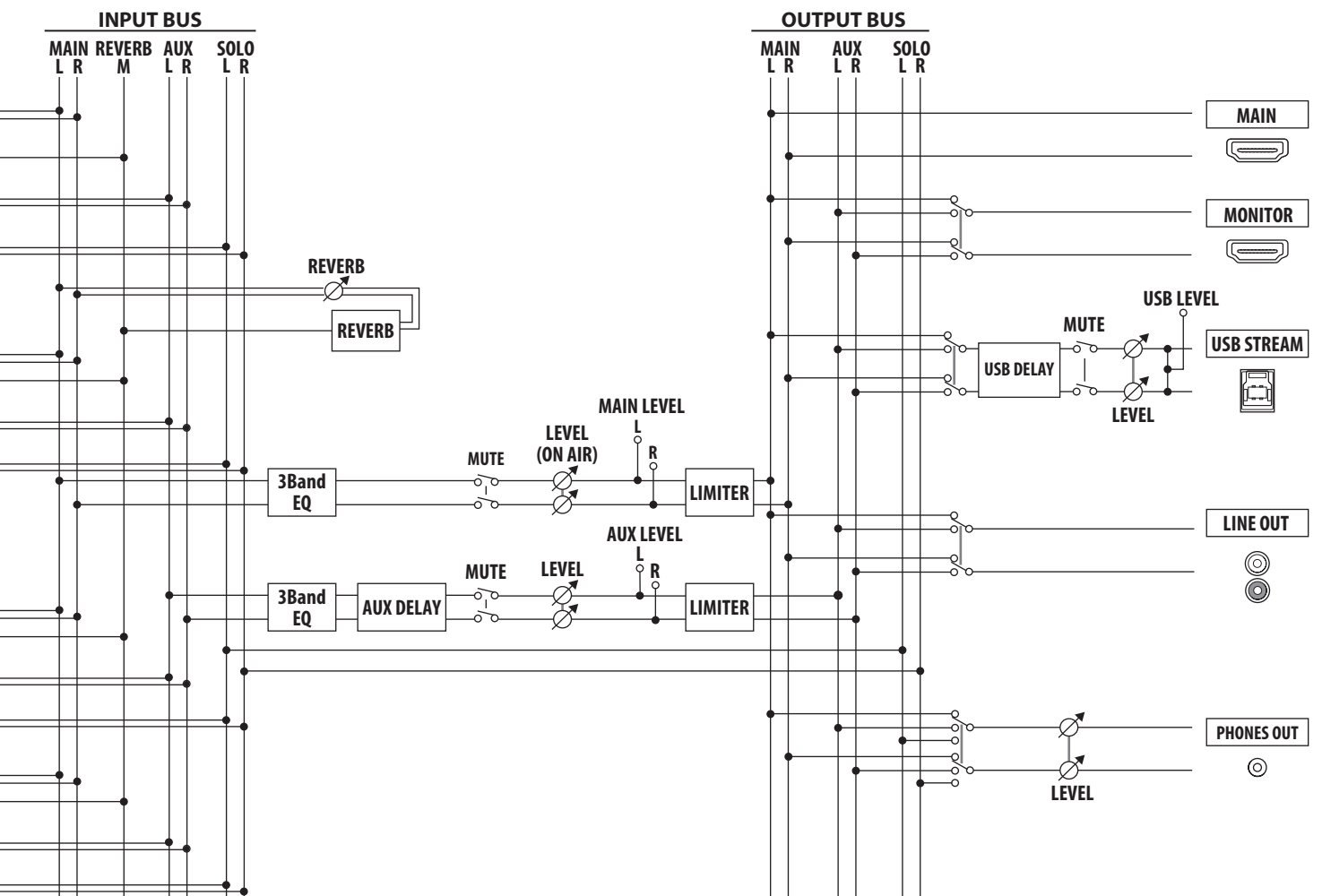
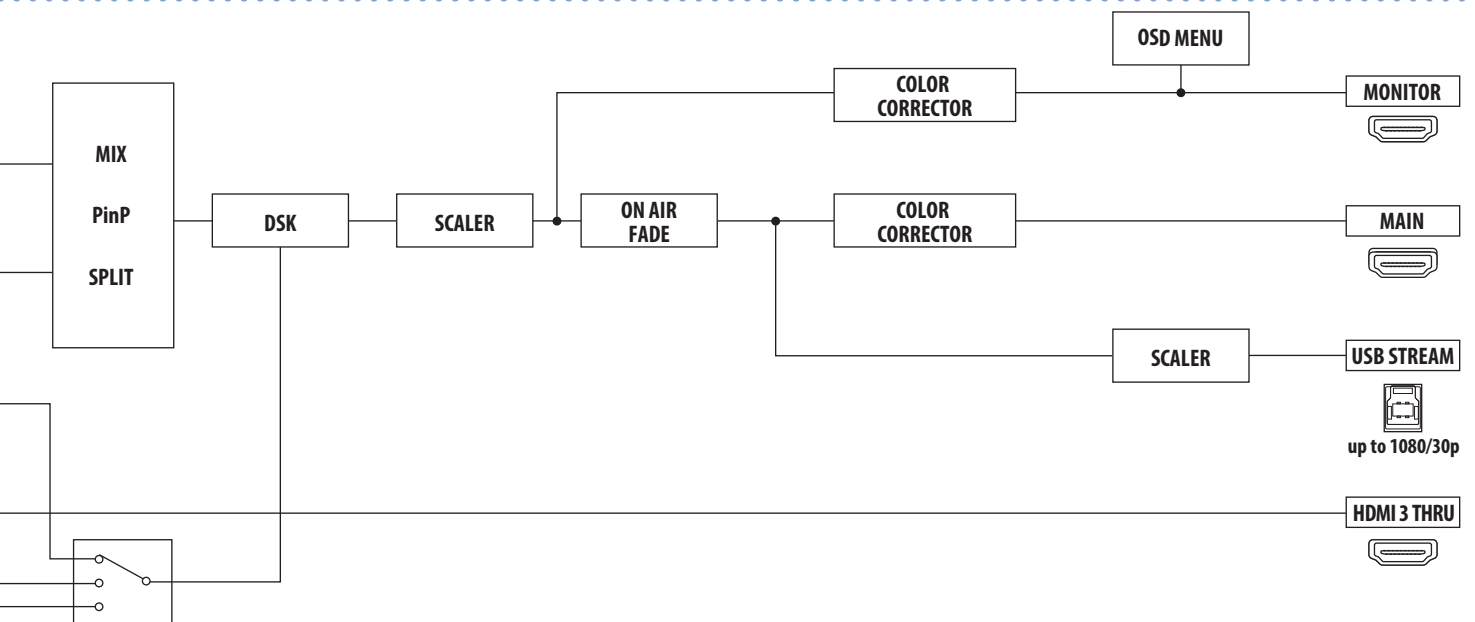

Main Specifications

Roland VR-1HD: AV Streaming Mixer

Video		
Video Processing	4:4:4 (Y/Pb/Pr), 10-bit	
Input Connectors	VIDEO INPUT 1–3 connectors	HDMI type A x 3 * HDCP Supported. * Multi-format Supported.
Output Connectors	MAIN connector	HDMI type A * HDCP Supported
	MONITOR connector	
	THRU connector	
	USB STREAM port	USB B type
Input Formats	480/59.94i, 576/50i, 480/59.94p, 576/50p, 720/59.94p, 720/50p, 1080/59.94i, 1080/50i, 1080/59.94p, 1080/50p VGA (640 x 480/60 Hz), SVGA (800 x 600/60 Hz), XGA (1024 x 768/60 Hz), HD (1280 x 720/60 Hz), WXGA (1280 x 800/60 Hz) SXGA (1280 x 1024/60 Hz), FWXGA (1366 x 768/60 Hz), SXGA+ (1400 x 1050/60 Hz), UXGA (1600 x 1200/60 Hz) FHD (1920 x 1080/60 Hz), WUXGA (1920 x 1200/60 Hz) * The refresh rate is the maximum value of each resolution. * Conforms to VESA DMT Version 1.0 Revision 11. * 1920 x 1200, 60 Hz: Reduced blanking * The video signal frame rate can be selected at the SYSTEM menu (59.94 Hz or 50 Hz).	
Output Formats	MAIN, MONITOR connectors 720/59.94p, 720/50p, 1080/59.94i, 1080/50i, 1080/59.94p, 1080/50p, XGA (1024 x 768/60 Hz) (*1), WXGA (1280 x 800/60 Hz) (*1) SXGA (1280 x 1024/60 Hz) (*1), FWXGA (1366 x 768/60 Hz) (*1), SXGA+ (1400 x 1050/60 Hz) (*1), UXGA (1600 x 1200/60 Hz) FHD (1920 x 1080/60 Hz), WUXGA (1920 x 1200/60 Hz) * The video signal frame rate can be selected at the SYSTEM menu (59.94 Hz or 50 Hz). USB STREAM port 854 x 480/29.97p, 854 x 480/25p, 854 x 480/59.94p, 854 x 480/50p, 720/29.97p, 720/25p, 720/59.94p, 720/50p, 1080/29.97p, 1080/25p * The video signal frame rate can be selected at the SYSTEM menu (59.94 Hz or 50 Hz).	
Still Image (*2)	Maximum Size	1920 x 1200 pixels
	Format	Windows Bitmap File (.bmp), 24-bit color, uncompressed
Video Effects	Scene	PinP, Split
	Transition	Black fade, Mix fade
	Key Composition:	Luminance key
	Other	Still Image playback, Output fade (Audio, Video: WHITE or BLACK), Test pattern output

(*1) Output refresh rate is 75 Hz when frame rate is set to 50 Hz.

(*2) It can be loaded up to 2 files from USB flash drive at startup.

Audio		
Audio Processing	Sample rate	48 kHz, 24 bits
Audio Formats	VIDEO INPUT 1–3 connectors	Linear PCM, 48 kHz, 24 bits, stereo
	USB STREAM port	Linear PCM, 48 kHz, 16 bits, stereo
Input Connectors	VIDEO INPUT 1–3 connectors	HDMI type A
	MIC 1–2 jacks	Combo type (XLR, 1/4-inch TRS phone), phantom power (DC 48 V, 10 mA Max)
	LINE IN jacks	RCA phono type
	USB STREAM port	USB B type
Output Connectors	MAIN connector	HDMI type A
	MONITOR connector	HDMI type A
	LINE OUT jacks	RCA phono type
	USB STREAM port	USB B type
	PHONES jack	Stereo miniature phone type
Nominal Input Level	MIC 1–2 jacks	-60– +4 dBu (Maximum input level: +28 dBu)
	LINE IN jacks	-10 dBu (Maximum input level: +8 dBu)
Input Impedance	MIC 1–2 jacks	Minimum 10 k ohms (balanced, HEAD AMP GAIN: 0– +17 dBu) Minimum 5 k ohms (balanced, HEAD AMP GAIN: +17– +64 dBu)
	LINE IN jacks	15 k ohms
Nominal Output Level	LINE OUT jacks	-10 dBu (Maximum input level: +8 dBu)
	PHONES jack	92 mW + 92 mW (32 ohms)
Output Impedance	LINE OUT jacks	1 k ohms
	PHONES jack	10 ohms
Audio Effects	Auto mixing, Echo canceller, Howling canceller, EQ, Delay, Compressor, HPF, Gate, Reverb, Limiter, Voice changer	
Audio Player	Number of Players	4
	Data Format	WAV (Linear PCM, 48 kHz, 16 bits stereo/44.1 kHz, 16 bits, stereo)

Common Section		
Connectors	USB MEMORY port (HOST)	USB A type (For USB flash drive, Still image, Audio player)
	USB STREAM port (DEVICE)	USB B type (For USB-VIDEO (USB 3.0), USB-AUDIO (USB 2.0): stereo 1 IN/1 OUT, Remote control, System update)
	DC IN jack	
Functions	Scene memory: 5, Panel lock function, EDID emulator, Auto switching (Auto scan, Beat sync switching, Video follows audio)	
Power Supply	AC adaptor	
Current Draw	2 A	
Power Consumption	24 W	
Operation Temperature	+0 to +40 degrees Celsius +32 to +104 degrees Fahrenheit	
Dimensions	314 (W) x 169 (D) x 66 (H) mm 12-3/8 (W) x 6-11/16 (D) x 2-5/8 (H) inches	
Weight (excluding AC adaptor)	1.6 kg 3 lbs 9 oz	
Accessories	Startup Guide, Leaflet "USING THE UNIT SAFELY," AC adaptor, Power cord	

* 0 dBu=0.775 Vrms

* This document explains the specifications of the product at the time that the document was issued. For the latest information, refer to the Roland website.

Dimensions

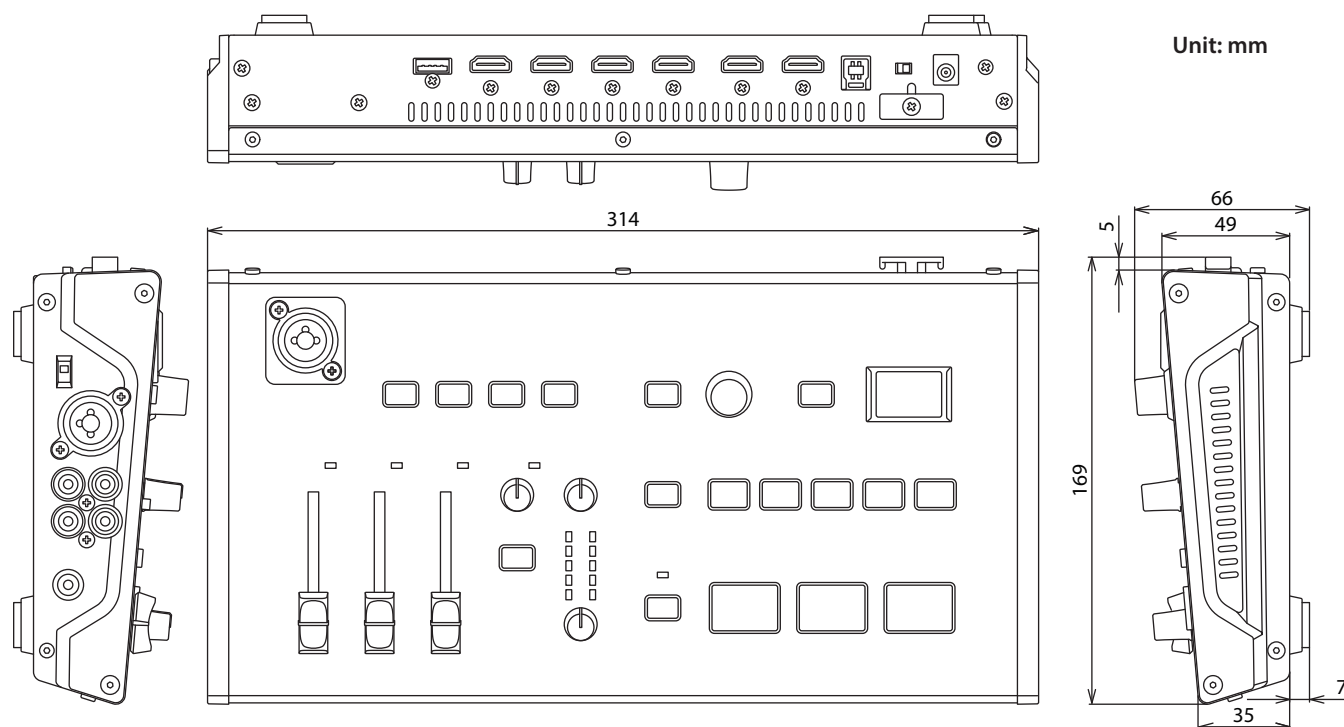

Shortcut List

Operation	Menu name
[MENU] + AUDIO EFFECTS [1]	AUDIO EFFECTS 1
[MENU] + AUDIO EFFECTS [2]	AUDIO EFFECTS 2
[MENU] + AUDIO EFFECTS [3]	AUDIO EFFECTS 3
[MENU] + AUDIO EFFECTS [4]	AUDIO EFFECTS 4
[MENU] + [MIC 1] fader	INPUT MIC 1
[MENU] + [MIC 2] fader	INPUT MIC 2
[MENU] + [LINE] fader	INPUT LINE
[MENU] + [USB STREAM] knob	AUDIO USB STREAM
[MENU] + [MAIN] knob	MAIN BUS
[MENU] + [KEY]	KEY
[MENU] + [ON AIR]	ON AIR
[SCENE EDIT]	SCENE
[MENU] + SCENE [A]	SCENE A
[MENU] + SCENE [B]	SCENE B
[MENU] + SCENE [C]	SCENE C
[MENU] + SCENE [D]	SCENE D
[MENU] + SCENE [E]	SCENE E
[MENU] + [AUTO SW]	AUTO SWITCHING
[MENU] + INPUT [1]	VIDEO INPUT 1
[MENU] + INPUT [2]	VIDEO INPUT 2
[MENU] + INPUT [3]	VIDEO INPUT 3

- Roland is an either registered trademark or trademark of Roland Corporation in the United States and/or other countries.
- Company names and product names appearing in this document are registered trademarks or trademarks of their respective owners.