



STAIRVILLE

Z100M Par 64 LED
3000K 100W

LED PAR

Musikhaus Thomann
Thomann GmbH
Hans-Thomann-Straße 1
96138 Burgebrach
Germany
Telephone: +49 (0) 9546 9223-0
E-mail: info@thomann.de
Internet: www.thomann.de

03.09.2019, ID: 443912

Table of contents

1	General notes	5
	1.1 Further information.....	6
	1.2 Notational conventions.....	7
	1.3 Symbols and signal words.....	8
2	Safety instructions	11
3	Features	18
4	Installation	19
5	Starting up	23
6	Connections and controls	26
7	Operating	29
	7.1 Starting the device.....	29
	7.2 Operating on the unit.....	29
	7.3 Menu overview.....	44
	7.4 Functions in 1-channel DMX mode.....	45
	7.5 Functions in 2-channel DMX mode.....	45

7.6	Functions in 3-channel DMX mode.....	46
8	Technical specifications.....	48
9	Plug and connection assignments.....	50
10	Troubleshooting.....	51
11	Cleaning.....	54
12	Protecting the environment.....	55

1 General notes

This manual contains important instructions for the safe operation of the unit. Read and follow the safety instructions and all other instructions. Keep the manual for future reference. Make sure that it is available to all those using the device. If you sell the unit please make sure that the buyer also receives this manual.

Our products are subject to a process of continuous development. Thus, they are subject to change.

1.1 Further information

On our website (www.thomann.de) you will find lots of further information and details on the following points:

Download	This manual is also available as PDF file for you to download.
Keyword search	Use the search function in the electronic version to find the topics of interest for you quickly.
Online guides	Our online guides provide detailed information on technical basics and terms.
Personal consultation	For personal consultation please contact our technical hotline.
Service	If you have any problems with the device the customer service will gladly assist you.

1.2 Notational conventions

This manual uses the following notational conventions:

Letterings

The letterings for connectors and controls are marked by square brackets and italics.

Examples: *[VOLUME]* control, *[Mono]* button.

Displays

Texts and values displayed on the device are marked by quotation marks and italics.

Examples: *'24ch'*, *'OFF'*.

Instructions



The individual steps of an instruction are numbered consecutively. The result of a step is indented and highlighted by an arrow.

Example:

- 1.** ▶ Switch on the device.
- 2.** ▶ Press *[Auto]*.
 - ⇒ Automatic operation is started.
- 3.** ▶ Switch off the device.

1.3 Symbols and signal words

In this section you will find an overview of the meaning of symbols and signal words that are used in this manual.

Signal word	Meaning
DANGER!	This combination of symbol and signal word indicates an immediate dangerous situation that will result in death or serious injury if it is not avoided.
WARNING!	This combination of symbol and signal word indicates a possible dangerous situation that can result in death or serious injury if it is not avoided.
NOTICE!	This combination of symbol and signal word indicates a possible dangerous situation that can result in material and environmental damage if it is not avoided.
Warning signs	Type of danger
	Warning – high-voltage.
	Warning – suspended load.

Warning signs	Type of danger
	Warning – danger zone.

2 Safety instructions

Intended use

This device is intended for use as an electronic lighting effect by means of LED technology. The device is designed for professional use and is not suitable for use in households. Use the device only as described in this user manual. Any other use or use under other operating conditions is considered to be improper and may result in personal injury or property damage. No liability will be assumed for damages resulting from improper use.

This device may be used only by persons with sufficient physical, sensorial, and intellectual abilities and having corresponding knowledge and experience. Other persons may use this device only if they are supervised or instructed by a person who is responsible for their safety.

Extend the life of the device by regular breaks in operation and avoid switching it on and off frequently. This device is not suitable for continuous use.

Safety



DANGER!

Danger for children

Ensure that plastic bags, packaging, etc. are disposed of properly and are not within reach of babies and young children. Choking hazard!

Ensure that children do not detach any small parts (e.g. knobs or the like) from the unit. They could swallow the pieces and choke!

Never let children unattended use electrical devices.



DANGER!

Electric shock caused by high voltages inside

Within the device there are areas where high voltages may be present. Never remove any covers.

There are no user-serviceable parts inside.

Do not use the device if covers, protectors or optical components are missing or damaged.



DANGER!

Electric shock caused by short-circuit

Always use proper ready-made insulated mains cabling (power cord). Do not modify the mains cable. Failure to do so could result in electric shock/death or fire. If in doubt, seek advice from a registered electrician.



WARNING!

Risk of injury caused by falling objects

Make sure that the installation complies with the standards and rules that apply in your country. Always secure the device with a secondary safety attachment, such as a safety cable or a safety chain.



WARNING!

Eye damage caused by high light intensity

Never look directly into the light source.



WARNING!

Risk of epileptic shock

Strobe lighting can trigger seizures in photosensitive epilepsy. Sensitive persons should avoid looking at strobe lights.



NOTICE!

Risk of fire

Do not block areas of ventilation. Do not install the device near any direct heat source. Keep the device away from naked flames.



NOTICE!

Operating conditions

This device has been designed for indoor use only. To prevent damage, never expose the device to any liquid or moisture. Avoid direct sunlight, heavy dirt, and strong vibrations.

Only operate the device within the ambient conditions specified in the chapter 'Technical specifications' of this user manual. Avoid heavy temperature fluctuations and do not switch the device on immediately after it was exposed to temperature fluctuations (for example after transport at low outside temperatures).

Dust and dirt inside can damage the unit. When operated in harmful ambient conditions (dust, smoke, nicotine, fog, etc.), the unit should be maintained by qualified service personnel at regular intervals to prevent overheating and other malfunction.



NOTICE!

Power supply

Before connecting the device, ensure that the input voltage (AC outlet) matches the voltage rating of the device and that the AC outlet is protected by a residual current circuit breaker. Failure to do so could result in damage to the device and possibly injure the user.

Unplug the device before electrical storms occur and when it is unused for long periods of time to reduce the risk of electric shock or fire.

3 Features

Special features of the device:

- 1 × COB LED (100 W)
- Stand-alone, master-slave or DMX mode operation
- Control via DMX or via buttons and display on the unit
- Robust metal housing with bracket and colour filter frame holder
- Suitable for use in clubs, bars, as back or front light on stages
- Power adapter included

For technological reasons, the light output of LEDs decreases over their lifetime. This effect increases with higher operating temperature. You can extend the service life of the illuminants by providing adequate ventilation and operating the LEDs with the lowest possible brightness.

4 Installation

Unpack and carefully check that there is no transportation damage before using the unit. Keep the equipment packaging. To fully protect the device against vibration, dust and moisture during transportation or storage use the original packaging or your own packaging material suitable for transport or storage, respectively.



WARNING!

Risk of injury caused by falling objects

Make sure that the installation complies with the standards and rules that apply in your country. Always secure the device with a secondary safety attachment, such as a safety cable or a safety chain.



NOTICE!

Risk of overheating

The distance between light output and the illuminated surface must be more than 1.5 m (19.7in).

Provide sufficient ventilation.

The ambient temperature must always be below 40 °C (104 °F).



NOTICE!

Use of stands

When mounting the device onto a stand, ensure that the stand is in a safe and stable position and that the weight of the device does not exceed the maximum permissible load capacity of the stand.

**NOTICE!****Possible data transmission errors**

For error-free operation make use of dedicated DMX cables and do not use ordinary microphone cables.

Never connect the DMX input or output to audio devices such as mixers or amplifiers.

Mounting options

You can install the device hanging or on a tripod. When in use, the device must always be attached to a solid surface or an approved truss. Use the opening of the bracket provided for mounting.

Always work from a stable platform whenever installing, moving or servicing the unit. In doing so, the area underneath the unit must be cordoned off.

The safety cable must be attached to the safety eyelet.



Please note that this device must not be connected to a dimmer.

5 Starting up

Create all connections while the device is off. Use the shortest possible high-quality cables for all connections. Take care when running the cables to prevent tripping hazards.

Connections in DMX mode

Connect the DMX input of the device to the DMX output of a DMX controller or another DMX device. Connect the output of the first DMX device to the input of the second one, and so on to form a daisy chain. Always ensure that the output of the last DMX device in the daisy chain is terminated with a resistor ($110\ \Omega$, $\frac{1}{4}\text{ W}$).

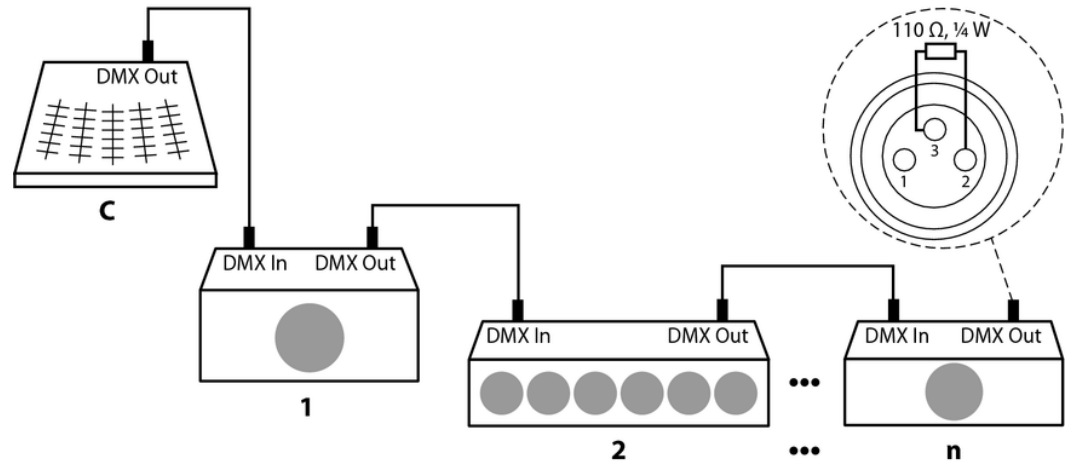

DMX indicator

When the device and the DMX controller are operational, the DMX indicator in the display shows that a DMX signal is being received on the input.

Connections in 'Master / Slave' mode

When you configure a group of devices in 'Master / Slave' mode, the first unit will control the others. This feature is especially useful to start a show without much programming. Connect the DMX output of the master unit to the DMX input of the first slave unit. Then connect the DMX output of the first slave unit to the DMX input of the second slave unit and so on.

6 Connections and controls

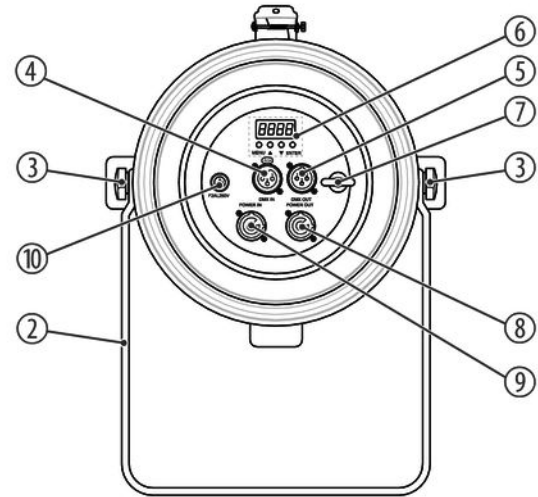
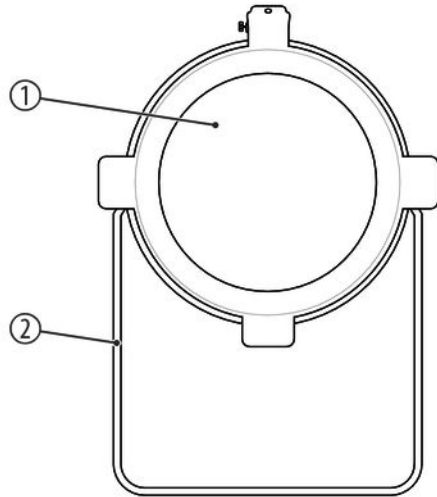

1	COB LED (100 W)
2	Bracket for floor placement or hanging
3	Locking screws for the bracket
4	<i>[DMX IN]</i> DMX input.
5	<i>[DMX OUT]</i> DMX output
6	Display <i>[MENU]</i> Calls up the main menu or a submenu. ▲ Navigates upwards in a menu list. Increases the displayed value by one. ▼ Navigates downwards in a menu list. Decreases the displayed value by one.

	<i>[ENTER]</i> Confirms a selected value.
7	Safety cable eyelet.
8	<i>[POWER OUT]</i> Lockable output socket (Power Twist) for the power supply of further units
9	<i>[POWER IN]</i> Lockable input socket (Power Twist) for power supply
10	Fuse holder If the fuse blows, replace it with a new fuse of the same type. You must first disconnect the device from the power supply.

7 Operating

7.1 Starting the device

Connect the device to the power supply to start operation. The fan starts to work and the LED lights up. The device is immediately ready for use and the display shows 'A001' an.

7.2 Operating on the unit

1. ▶ Press *[MENU]* to activate the main menu.
2. ▶ Press again *[MENU]* to call up further menu items.
3. ▶ To activate the respectively shown menu item, press *[ENTER]*.

4. ➤ Use ▲ and ▼ to change the respectively indicated value. To apply changed values and settings, press [ENTER].
5. ➤ With [MENU] you return to the previous menu level.

If you do not press any button for about 8 seconds, the display will turn off. The set values are retained even when the device is disconnected from the mains power supply.

DMX address

1. ➤ Press *[MENU]* and then *[MENU]* again. The display shows 'Addr'. Confirm with *[ENTER]*.
2. ➤ Use ▲ | ▼ to select the desired AMD address between 1 and 512. Make sure that this number matches the configuration of your DMX controller.
3. ➤ Press *[ENTER]* to accept the selection.

This setting is only relevant when the device is controlled via DMX.

When the DMX mode is active, a dot flashes in the second digit of the display.

DMX mode

1. ➤ Press *[MENU]* and then ▲ | ▼ repeatedly until the display shows 'Chnd'. Confirm with *[ENTER]*.
2. ➤ Use ▲ | ▼ to select the desired DMX mode (1, 2 or 3 channels). Depending on the selected mode, the display shows '1Ch', '2Ch' or '3Ch' an.
3. ➤ Press *[ENTER]* to accept the selection.

This setting is only relevant when the device is controlled via DMX.

When the DMX mode is active, a dot flashes in the second digit of the display.

Dimmer settings

1. ➤ Press *[MENU]* and then ▲ | ▼ repeatedly until the display shows 'Dlnd'. Confirm with *[ENTER]*.
2. ➤ Use ▲ | ▼ to select the desired dimmer setting.
3. ➤ Press *[ENTER]* to accept the selection.

Display	Meaning
'stdA'	Standard setting
'st9e'	Stage setting
'tu'	TV setting
'ArAL'	Building setting
'thAL'	Theatre setting

Refresh rate dimmer

1. ➤ Press *[MENU]* and then ▲ | ▼ repeatedly until the display shows *'FrEq'*. Confirm with *[ENTER]*.
2. ➤ Use ▲ | ▼ to select the desired refresh rate of the dimmer between 900 Hz and 25 kHz (display shows *'900' ... '25t'*).
3. ➤ Press *[ENTER]* to accept the selection.

Display	Display
'900'	'2500'
'1000'	'4000'
'1100'	'5000'
'1200'	'10t'
'1300'	'15t'

Display	Display
'1400'	'20t'
'1500'	'25t'

Gamma correction

1. ➤ Press *[MENU]* and then ▲ | ▼ repeatedly until the display shows '9Ann'. Confirm with *[ENTER]*.
2. ➤ Use ▲ | ▼ to select the desired Gamma value.
3. ➤ Press *[ENTER]* to accept the selection.

Display	Meaning
'NO'	no Gamma correction
'2.0'	Gamma correction with exponent 2.0
'2.2'	Gamma correction with exponent 2.2
'2.4'	Gamma correction with exponent 2.4
'2.6'	Gamma correction with exponent 2.6
'2.8'	Gamma correction with exponent 2.8

Manual control

1. ➤ Press *[MENU]* and then ▲ | ▼ repeatedly until the display shows 'MAnu'. Confirm with *[ENTER]*.
2. ➤ Use ▲ | ▼ to select a value between '0' and '255'.
3. ➤ Press *[ENTER]* to accept the selection.

Slave mode

1. ➤ Press *[MENU]* and then ▲ | ▼ repeatedly until the display shows 'Slnd'. Confirm with *[ENTER]*.
2. ➤ Use ▲ | ▼ to select the Slave mode (display shows 'Sl 1').
3. ➤ Press *[ENTER]* to accept the selection.
 - ⇒ The device is now working in slave mode, i.e. it will exactly copy the movement of the controlling master device, correct wiring provided.

To exit slave mode, select '*Mast*' and confirm with *[ENTER]*.

This setting is only relevant if the device is not controlled via DMX.

Behaviour on DMX control failure

1. ➤ Press *[MENU]* and then ▲ | ▼ repeatedly until the display shows 'Lost'. Confirm with *[ENTER]*.
2. ➤ Use ▲ | ▼ to choose between 'blac', 'hold' and 'auto', to make the setting to be used when the DMX controller fails.
3. ➤ Press *[ENTER]* to accept the selection.

Display	Meaning
'blac'	Spotlight turns off.
'hold'	Last effect is being held.
'auto'	Spotlight turns on.

Display illumination

1. ➤ Press *[MENU]* and then ▲ | ▼ repeatedly until the display shows 'LEd'. Confirm with *[ENTER]*.
2. ➤ Use ▲ | ▼ to choose between 'On' (display permanently on) and 'oFF' (display turns off after a few seconds in case of inactivity).
3. ➤ Press *[ENTER]* to accept the selection.

Rotating the Display

1. ➤ Press ▲ | ▼ repeatedly until the display shows 'dISP'. Confirm with *[ENTER]*.
2. ➤ Use ▲ | ▼ to choose between 'On' (display rotated by 180°) and 'oFF' (display not rotated).
3. ➤ Press *[ENTER]* to accept the selection.

Device temperature

- 1.** ▶ Press *[MENU]* and then ▲ | ▼ repeatedly until the display shows 'tEnP'. Confirm with *[ENTER]*.
 - ⇒ The display indicates the device temperature (display shows '00C'... '90C').
- 2.** ▶ Press *[ENTER]*.
 - ⇒ The menu is closed.

Total runtime

- 1.** ▶ Press *[MENU]* and then ▲ | ▼ repeatedly until the display shows 'FhrS'. Confirm with *[ENTER]*.
 - ⇒ The display shows the total runtime of the device.
- 2.** ▶ Press *[ENTER]*.
 - ⇒ The menu is closed.

Software version

1. ➤ Press *[MENU]* and then ▲ | ▼ repeatedly until the display shows 'uEr'. Confirm with *[ENTER]*.
 - ⇒ The display shows the current software version used by the device.
2. ➤ Press *[ENTER]*.
 - ⇒ The menu is closed.

Reset

- Press *[MENU]* and then ▲ | ▼ repeatedly until the display shows 'dEFA'. Confirm with *[ENTER]*.
 - ⇒ The device is reset to the default settings.

7.3 Menu overview

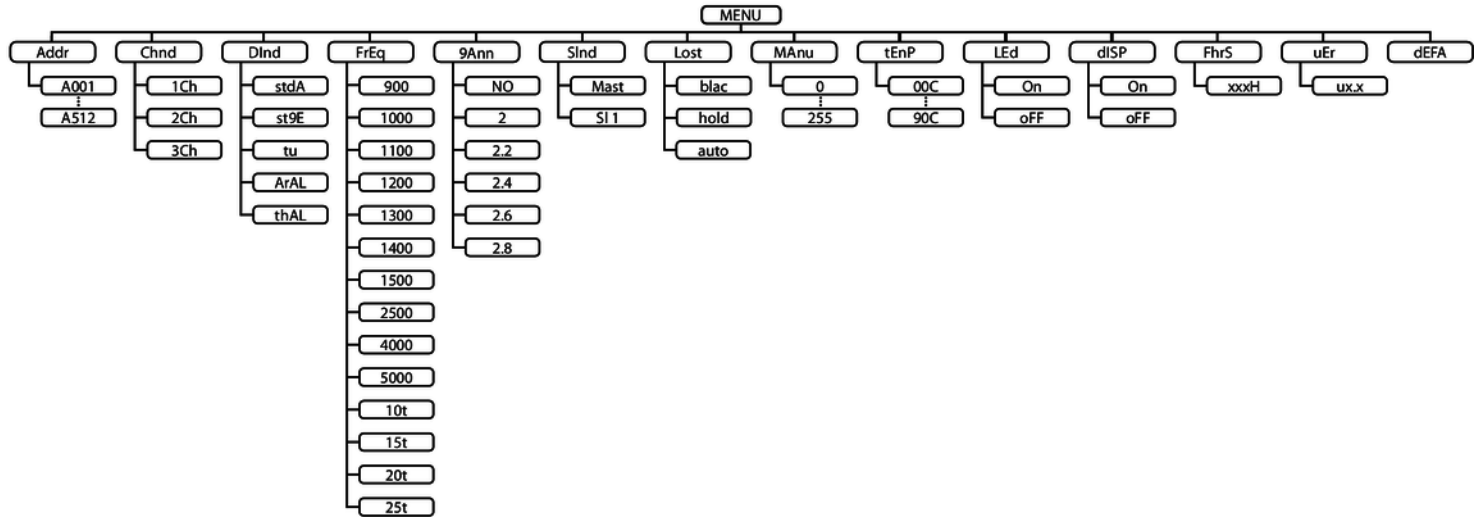

7.4 Functions in 1-channel DMX mode

Channel	Value	Function
1	0 ... 255	Dimmer (0 % to 100 %)

7.5 Functions in 2-channel DMX mode

Channel	Value	Function
1	0 ... 255	Dimmer (0 % to 100 %)
2	0 ... 015	Strobe effect
	016 ... 095	Stroboscope effect, increasing speed (1 – 25 Hz)

Channel	Value	Function
	096 ... 175	Stroboscope effect, increasing speed (1 Hz)
	176 ... 255	Stroboscope effect, random speed

7.6 Functions in 3-channel DMX mode

Channel	Value	Function
1	0 ... 255	Dimmer (0 % to 100 %)
2	0 ... 255	Fine dimmer
3	0 ... 015	Strobe effect
	016 ... 095	Stroboscope effect, increasing speed (1 – 25 Hz)

Channel	Value	Function
	096 ... 175	Stroboscope effect, increasing speed (1 Hz)
	176 ... 255	Stroboscope effect, random speed

8 Technical specifications

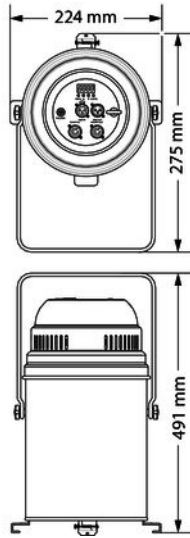

Illuminant	1 × COB LED (100 W), white
Colour temperature	3000 K
Dimmer	0 – 100 %
Refresh rate dimmer	900 Hz – 25 kHz
Beam angle	11 °...35 °
Number of DMX channels	1, 2 or 3 channels, depending on operating mode
Electronic shutter	1 – 25 Hz
Operating supply voltage	100 – 240 V ~ 50 / 60 Hz
Power consumption	115 W
Fuse	5 mm × 20 mm, 2.0 A, 250 V, fast-acting

Dimensions (W × H × D, with bracket)	224 mm × 275 mm × 491 mm
Weight	3.4 kg

Environmental conditions

Temperature range	0 °C...40 °C
Relative humidity	50 %, non-condensing

9 Plug and connection assignments

Introduction

This chapter will help you select the right cables and plugs to connect your valuable equipment so that a perfect light experience is guaranteed.

Please take our tips, because especially in 'Sound & Light' caution is indicated: Even if a plug fits into a socket, the result of an incorrect connection may be a destroyed DMX controller, a short circuit or 'just' a not working light show!

DMX connections

The unit offers a 3-pin XLR socket for DMX output and a 3-pin XLR plug for DMX input. Please refer to the drawing and table below for the pin assignment of a suitable XLR plug.



Pin	Configuration
1	Ground, shielding
2	Signal inverted (DMX-, 'cold signal')
3	Signal (DMX+, 'hot signal')

10 Troubleshooting



NOTICE!

Possible data transmission errors

For error-free operation make use of dedicated DMX cables and do not use ordinary microphone cables.

Never connect the DMX input or output to audio devices such as mixers or amplifiers.

In the following we list a few common problems that may occur during operation. We give you some suggestions for easy troubleshooting:

Symptom	Remedy
The unit does not work, no light, the display is dark	Check the mains connection and the main fuse.
Apparently no function despite proper power supply	Check whether the device is in DMX mode. If so, check the unit in another mode.
No response to the DMX controller	<ol style="list-style-type: none">1. Check the DMX connectors and cables for proper connection.2. If the unit is in DMX mode and a DMX controller is connected and turned on, a dot on the second digit of the display will flash. If it doesn't, no valid DMX signal is received. Check whether the DMX controller is switched on. Check the DMX connectors and cables for proper connection.3. If the display dot is flashing but there is still no response, check the address settings and the DMX polarity.

Symptom	Remedy
	4. Try using another DMX controller.
	5. Check whether the DMX cables run near or parallel to high-voltage cables that may cause damage or interference to a DMX interface circuit.

If the procedures recommended above do not succeed, please contact our Service Center. You can find the contact information at www.thomann.de.

11 Cleaning

Optical lenses

Clean the optical lenses, that are accessible from the outside, regularly in order to optimize the light output. The frequency of cleaning depends on the operating environment: wet, smoky or particularly dirty surroundings can cause more accumulation of dirt on the optics of the device.

- Clean with a soft cloth using our lamp and lens cleaner (item no. 280122).
- Always dry the parts carefully.

Fan grids

The fan grids of the device must be cleaned on a regular basis to remove dust and dirt. Before cleaning, switch off the device and disconnect AC-powered devices from the mains. Use a lint-free damp cloth for cleaning. Never use solvents or alcohol for cleaning.

12 Protecting the environment

Disposal of the packaging material



For the transport and protective packaging, environmentally friendly materials have been chosen that can be supplied to normal recycling.

Ensure that plastic bags, packaging, etc. are properly disposed of.

Do not just dispose of these materials with your normal household waste, but make sure that they are collected for recycling. Please follow the notes and markings on the packaging.

Disposal of your old device



This product is subject to the European Waste Electrical and Electronic Equipment Directive (WEEE) in its currently valid version. Do not dispose with your normal household waste.

Dispose of this device through an approved waste disposal firm or through your local waste facility. When discarding the device, comply with the rules and regulations that apply in your country. If in doubt, consult your local waste disposal facility.

Z100M Par 64 LED 3000K 100W



Musikhaus Thomann · Hans-Thomann-Straße 1 · 96138 Burgebrach · Germany · www.thomann.de