

V-Drums
TD-50
 DRUM SOUND MODULE

Reference Manual

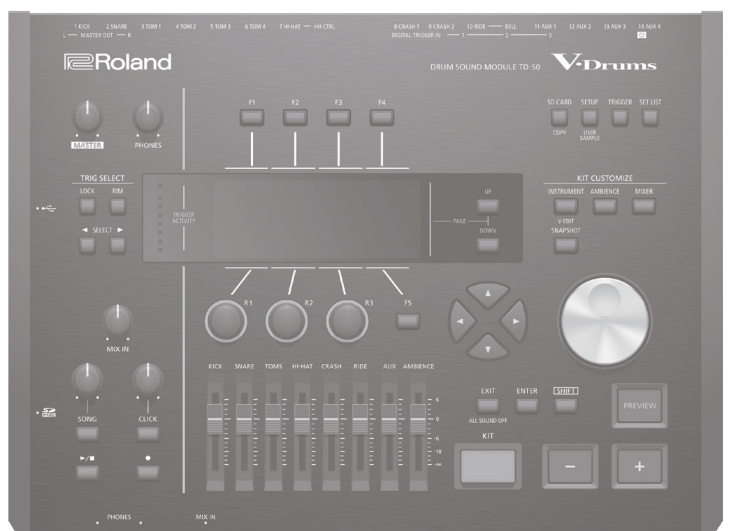

Contents

Getting Ready 4

| | |
|-----------------------------------|---|
| Overview of the TD-50..... | 4 |
| Drum Kits..... | 4 |
| About Memory..... | 5 |
| About Performance Techniques..... | 6 |

| | |
|-------------------------|---|
| Panel Descriptions..... | 7 |
|-------------------------|---|

| | |
|--|----|
| Turning the Power On/Off..... | 10 |
| Making the Power Automatically Turn off After a Time (AUTO OFF)..... | 10 |

| | |
|-----------------------------|----|
| Making Hi-hat Settings..... | 11 |
|-----------------------------|----|

| | |
|----------------------|----|
| Basic Operation..... | 12 |
|----------------------|----|

Performing 13

| | |
|---|----|
| Selecting a Drum Kit..... | 13 |
| Selecting a Drum Kit from the List..... | 13 |
| Cross-Stick Function..... | 13 |
| Stopping All Currently Played Sounds (ALL SOUND OFF)..... | 13 |

| | |
|-----------------------------|----|
| Playing with the Click..... | 13 |
|-----------------------------|----|

| | |
|---|----|
| Performing Along with a Song..... | 14 |
| Performing Along with an Audio Player Song..... | 14 |
| Performing Along with a TD-50 Song..... | 14 |
| Repeatedly Playing a Specified Region (A-B Repeat)..... | 14 |
| Changing the Settings of Each Song..... | 15 |
| Playing an Audio File as a Click (Click Track)..... | 15 |

| | |
|------------------------------------|----|
| Rhythm Training (QUIET COUNT)..... | 16 |
|------------------------------------|----|

| | |
|--|----|
| Registering/Recalling Favorite Drum Kits (FAVORITE)..... | 16 |
|--|----|

Recording 17

| | |
|--|----|
| Recording a Performance..... | 17 |
| Recording Your Drum Performance..... | 17 |
| Recording Your Performance Along with a Song..... | 17 |
| Deleting Recorded Data..... | 17 |
| Renaming Recorded Data..... | 18 |
| Exporting Recorded Data to an SD Card (SONG EXPORT)..... | 18 |

Customizing a Kit 19

| | |
|--|----|
| Editing an Instrument (INSTRUMENT)..... | 19 |
| Selecting an Instrument..... | 19 |
| Choosing a Pad to Edit..... | 20 |
| Auditioning the Sound of a Pad ([PREVIEW] button)..... | 20 |
| Adjusting the Mic Settings (MIC POSITION)..... | 20 |
| Adjusting the Attack and Release (TRANSIENT)..... | 20 |
| Layering Instruments (SUB INSTRUMENT)..... | 21 |

| | |
|--|----|
| Simulating the Ambience of a Performance Space (AMBIENCE)..... | 22 |
|--|----|

| | |
|--|----|
| Editing the Mixer (MIXER)..... | 22 |
| Specifying the Volume and Pan of Each Pad..... | 22 |
| Applying Effects..... | 23 |
| Adjusting the Overall Sound (MASTER COMPRESSOR/MASTER EQ)..... | 23 |

| | |
|--|----|
| Comparing with or Reverting to the Unedited Drum Kit (SNAPSHOT)..... | 24 |
|--|----|

| | |
|--|----|
| Editing a Drum Kit (MENU)..... | 24 |
| Setting the Volume..... | 24 |
| Specifying the Illumination Color of the [KIT] Button and Knobs..... | 25 |
| Renaming the Drum Kit..... | 25 |
| Performing with Brushes..... | 25 |
| Specifying the Tempo for Each Kit..... | 26 |
| Controlling Tonal Change..... | 26 |
| Making MIDI Transmit/Receive Settings for Each Pad..... | 27 |

| | |
|--|----|
| Importing and Playing Audio Files (USER SAMPLE)..... | 27 |
| Importing an Audio File (IMPORT)..... | 27 |
| Assigning a User Sample to an Instrument and Playing It..... | 28 |
| Listing the User Samples..... | 28 |
| Specifying How the User Sample Is Sounded..... | 28 |
| Specifying the Sounded Region of a User Sample..... | 29 |
| Deleting a User Sample..... | 29 |
| Renaming a User Sample..... | 29 |
| Organizing User Samples..... | 29 |

Utility Functions 30

| | |
|---|----|
| Using the TD-50 with a Computer..... | 30 |
| USB Driver Installation and Settings..... | 30 |
| Specifying the Output for USB Audio..... | 30 |
| Specifying the Input for USB Audio..... | 31 |

| | |
|------------------------------|----|
| Copying Settings (COPY)..... | 31 |
|------------------------------|----|

| | |
|--|----|
| Recalling Drum Kits Successively (SET LIST)..... | 33 |
| Creating a Set List..... | 33 |
| Using Set Lists..... | 34 |

Settings 35

Trigger Settings (TRIGGER) 35

- Specifying the Pad Type 35
- Specifying a Digitally-Connected Pad 35
- Adjusting the Pad Sensitivity..... 36
- Adjusting the Hi-Hat Settings 36
- Making Detailed Adjustments for the Trigger 36
- Making Detailed Settings for Digitally-Connected Pads..... 37
- Viewing Trigger Information for Each Pad..... 37
- Eliminate Crosstalk Between Pads (Crosstalk Cancellation).... 38

Backing Up Data to an SD Card (SD CARD)..... 39

- Backing Up All Settings (SAVE) 39
- Loading Backup Data from an SD Card (LOAD) 39
- Backing Up Drum Kit to an SD Card (1 KIT SAVE) 40
- Loading Kit Backup Data from an SD Card (1 KIT LOAD)..... 40
- Deleting Backup Data from an SD Card (DELETE/1 KIT DELETE) 41
- Checking the Usage Status of an SD Card (INFO)..... 41
- Formatting an SD Card (FORMAT)..... 41

Settings for the Entire TD-50 (SETUP) 42

- Audio Output Assignments (OUTPUT)..... 42
- Other Settings (OPTION)..... 44
- Assigning Functions to Foot Switches or Pads (CONTROL) 44
- MIDI Settings (MIDI) 45
- Viewing Information for the TD-50 Itself (INFO)..... 46
- Restoring the Factory Settings (FACTORY RESET) 46

Appendix 47

List of Displayed Messages 47

- Error Messages..... 47
- Other Messages..... 47

Troubleshooting..... 48

Main Specifications..... 49

Getting Ready

Overview of the TD-50

Drum Kits

On the TD-50, the sound you hear when you strike each pad is called an “instrument.” A “drum kit” is a set of sounds (instruments) assigned to the pads.

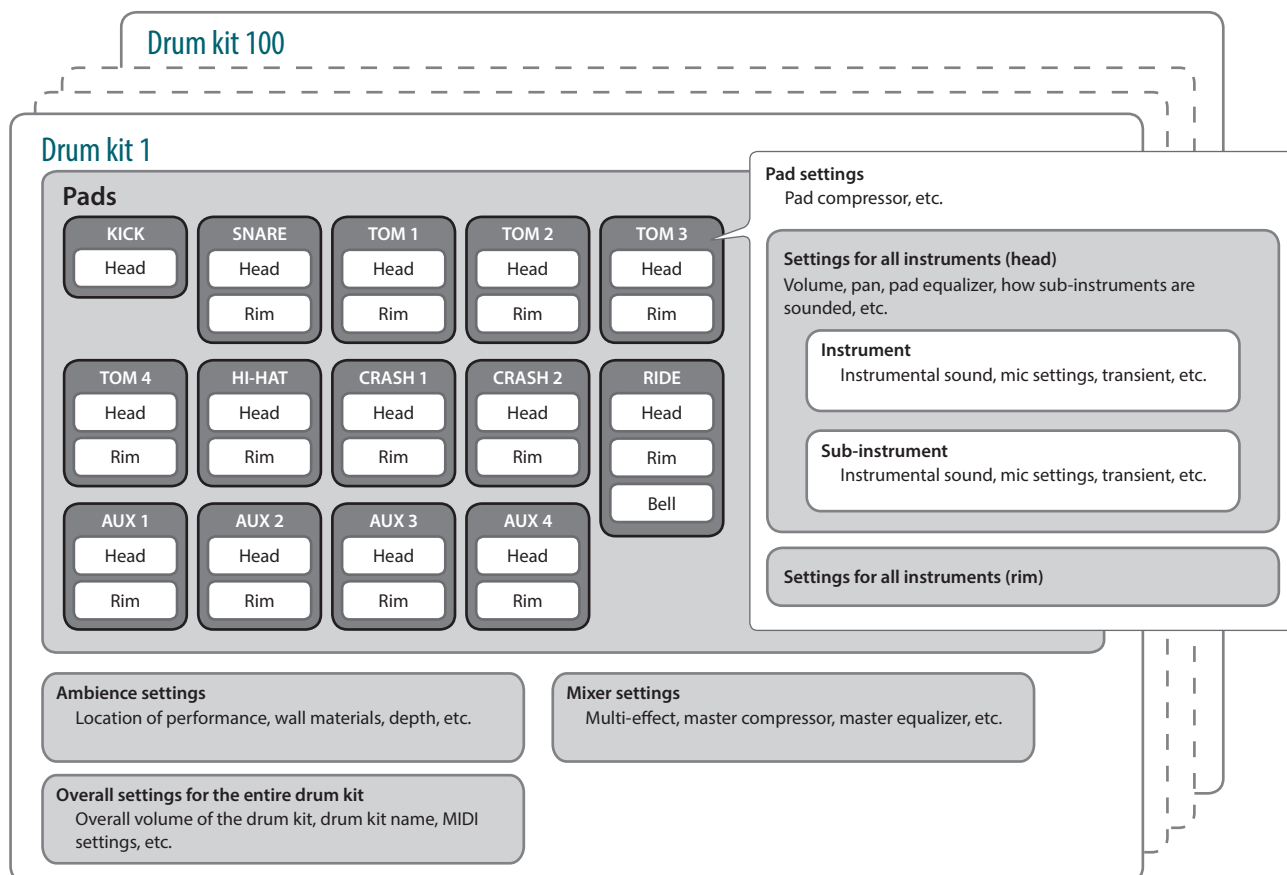

MEMO

- When you change a drum kit setting, the changed setting is saved automatically.
- For details on a drum kit's parameter structure, refer to “Data List” (PDF).

Instrument (p. 19)



An instrumental sound such as a snare drum or kick drum is called an “instrument.”

An instrument is assigned to each location of a pad that can be struck independently, such as the pad's head and rim.

You can also change the settings of each instrument to create your own sound. An instrument can reproduce the timbral changes caused by the depth of a drum shell, and lets you apply mic settings or transient effects.

An audio file that you create on your computer can also be loaded from an SD card into the TD-50 and played as an instrument (the user sample function).

Ambience (p. 22)



“Ambience” is an effect that simulates the acoustical character of the location in which you're performing.

You can adjust the room ambience (the type and size of the room), the reverb (reverberation), and the stereo enhancer (the sense of stereo spaciousness).

The ambience effect can be applied individually to each drum kit. You can also specify how strongly the effect applies to each pad.

Mixer (p. 22)



These settings adjust the volume balance, pan, and effects for each pad.

The TD-50's effects include the types shown below. Some effect types apply to individual pads, and some apply to the entire drum kit.

| Effect | Explanation |
|---|---|
| Pad equalizer/ Pad compressor (PAD COMP/PAD EQ) | An “equalizer” lets you adjust specific separate frequency ranges such as high, mid, and low. A “compressor” is an effect that reduces volume peaks, by modifying the attack and release of the sound. The pad equalizer can apply an effect to each separate strike location, and the pad compressor can apply an effect to each individual pad. |
| Multi-effects (MFX) | “Multi-effects” let you apply three effects that you choose from 30 types. Multi-effects can apply an effect to each individual drum kit. You can also specify how much effect is applied to each pad. |
| Master compressor/Master EQ (MASTER COMP/MASTER EQ) | Compressor and equalizer can be applied to the entire drum kit. |

About Memory

The area in which settings such as drum kits and trigger settings are stored is called “memory.”

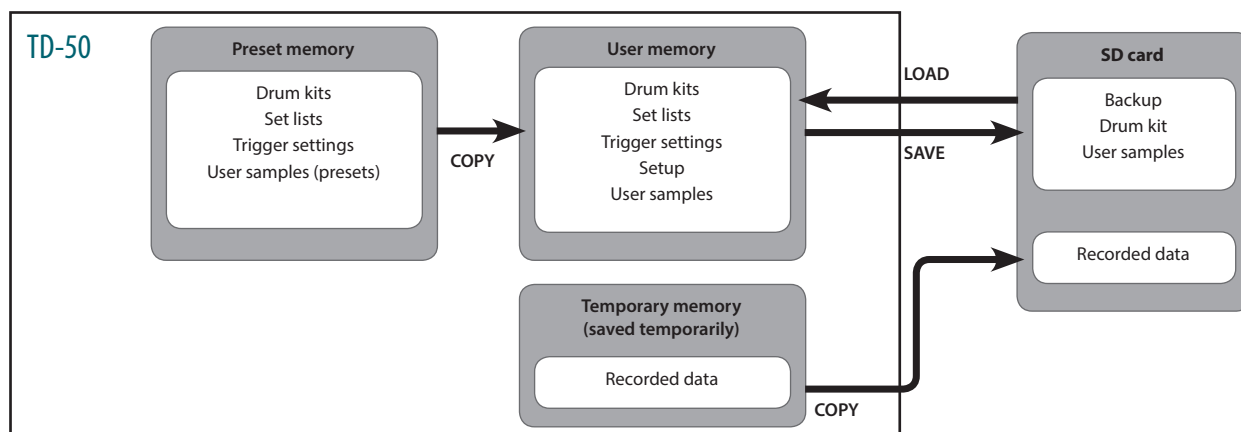

Preset memory

The factory settings are stored in preset memory.

You can restore the factory settings by copying preset memory data to user memory (p. 46).

The following settings are saved in preset memory.

- Drum kits (p. 4)
- Set lists (p. 33)
- Trigger settings (p. 35)
- User samples (presets) (p. 27)

* User samples (presets) cannot be copied. By executing a factory reset, you can return the user samples in user memory to their factory-set state.

User memory

This area stores your edits and performance settings.

Data from SD card or preset memory can also be loaded or copied into this area (p. 31).

The following settings are saved in user memory.

- Drum kits (p. 4)
- Set lists (p. 33)
- Trigger settings (p. 35)
- Setup (p. 42)
- User samples (p. 27)

Temporary memory (saved temporarily)

The data (one song) recorded on the TD-50 is held in the unit's temporary memory.

The recorded data in temporary memory can be copied to an SD card, or exported as an audio file (WAV) or SMF data to an SD card.

* When you turn off the power, the data recorded in temporary memory is erased.

SD card

The settings saved in user memory can be saved as a set on an SD card, allowing you to save (back up) up to 99 sets.

Separately from backups, 999 drum kits can also be saved.

Your performance on the TD-50 can also be recorded directly to an SD card.

MEMO

- The data that is saved on an SD card can be loaded into user memory, or copied. For details, refer to “Backing Up Data to an SD Card (SD CARD)” (p. 39).
- For details on the folder structure of an SD card, refer to “SD card folder structure” (p. 40).



About Performance Techniques

The TD-50 responds to a variety of performance techniques just like an acoustic drum set.

NOTE

- Use only wooden or plastic sticks. Using a carbon or metal stick may cause the sensor to malfunction.
- Use nylon brushes. Using metal brushes may cause the sensor to malfunction, and may scratch the pad.

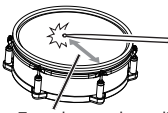
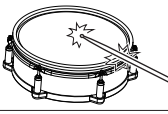
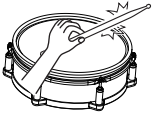
Pad



| Playing method | Explanation |
|--|---|
| Head shot  Tone changes depending on strike point | Hit only the head of the pad. For a snare drum, the tone will change naturally as you move the strike location from the center of the head toward the rim. |
| Rim shot  | Strike the head and the rim of the pad simultaneously. A sound (rim sound) different than the head shot will be heard. |
| Cross stick  | Strike the rim while placing your hand on the head. Snare sounds can produce different sounds in response to different playing techniques; for example they can produce a rim sound when played using a rim shot, or a cross-stick sound when played using a cross-stick technique. Either connect a pad that supports rim shot playing technique to the TRIGGER IN (2 SNARE) jack, or connect a pad that supports cross-stick technique and allows a digital connection (such as the PD-140DS) and assign it to the snare. * On units other than the PD-140DS, strike only the rim so as not to touch the head. * On some snare sounds, it might not be possible to play separate sounds in this way. |
| Playing with brushes  | You can use brushes to scrape the head (brush sweep). Either connect a mesh head pad to the TRIGGER IN (2 SNARE) jack, or connect a pad that supports digital connection and allows brush techniques (such as the PD-140DS), and assign it as the snare. * "Playing with brushes" function will be enabled in the future. The information will be announced at the Roland website. http://www.roland.com/support/ |

Change the nuance of the rim shot

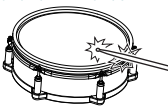
With certain snare and tom sounds, slight changes in the way you play rim shots changes the nuance.

| Playing method | Explanation |
|--|---|
| Normal rim shot (Open rim shot)  | Strike the head and rim simultaneously. |
| Shallow rim shot  | Simultaneously strike the head near the rim and the rim itself. |

Hi-Hat

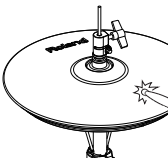
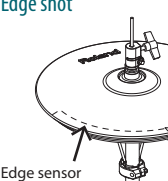
| Playing method | Explanation |
|--|--|
| Open/closed  | The hi-hat tone changes smoothly and continuously from open to closed in response to how far the pedal is pressed. You can also play the foot closed sound (playing the hi-hat with the pedal completely pressed down) and foot splash sound (playing the hi-hat with the pedal fully pressed and then instantly opening it). |
| Pressure (VH-13)  | When you strike the hi-hat while pressing on the pedal with the hi-hat closed, you can then change the closed tone in response to the pressure you place on the pedal. * The VH-11, FD-9, and FD-8 do not respond to pressure. |
| Bow shot  | This playing method involves striking the middle area of the top hi-hat. It corresponds to the sound of the "head-side" of the connected trigger input. |
| Edge shot  | This playing method involves striking the edge of the top hi-hat with the shoulder of the stick. When played as shown in the figure, the "rim-side" sound of the connected trigger input is triggered. * Striking directly on the edge (i.e., exactly from the side) will not produce the correct sound. Strike as shown in the illustration. |

* Do not strike the bottom of the top hi-hat, and do not strike the bottom hi-hat. Doing so will cause malfunctions.

Cymbal

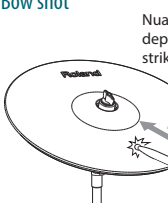
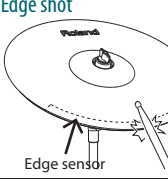
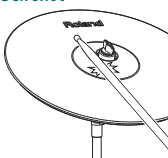
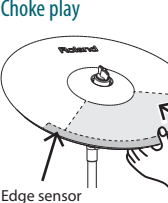
| Playing method | Explanation |
|--|--|
| Bow shot  | Nuance changes depending on the strike location. This is the most common playing method, playing the middle area of the cymbal. It corresponds to the sound of the "head-side" of the connected trigger input. |
| Edge shot  | This playing method involves striking the edge with the shoulder of the stick. When played as shown in the figure, the "rim-side" sound of the connected input is triggered. |
| Bell shot  | This is the technique of striking the bell. When the bell area shown in the illustration is struck, the bell sound is heard. Connect a compatible pad to the TRIGGER IN (10 RIDE - BELL) jack, or connect a pad that allows the bell shot technique and supports a digital connection (such as the CY-18DR), and assign it to ride. |
| Choke play  | If you use your hand to choke (grasp) the edge sensor after striking the cymbal, the sound stops. On the CY-18DR, placing your hand on the sensor will also stop the sound. When you strike the cymbal in the choked state, the sound is shorter. The choke technique can also be used on the hi-hat. |

Panel Descriptions

Top Panel

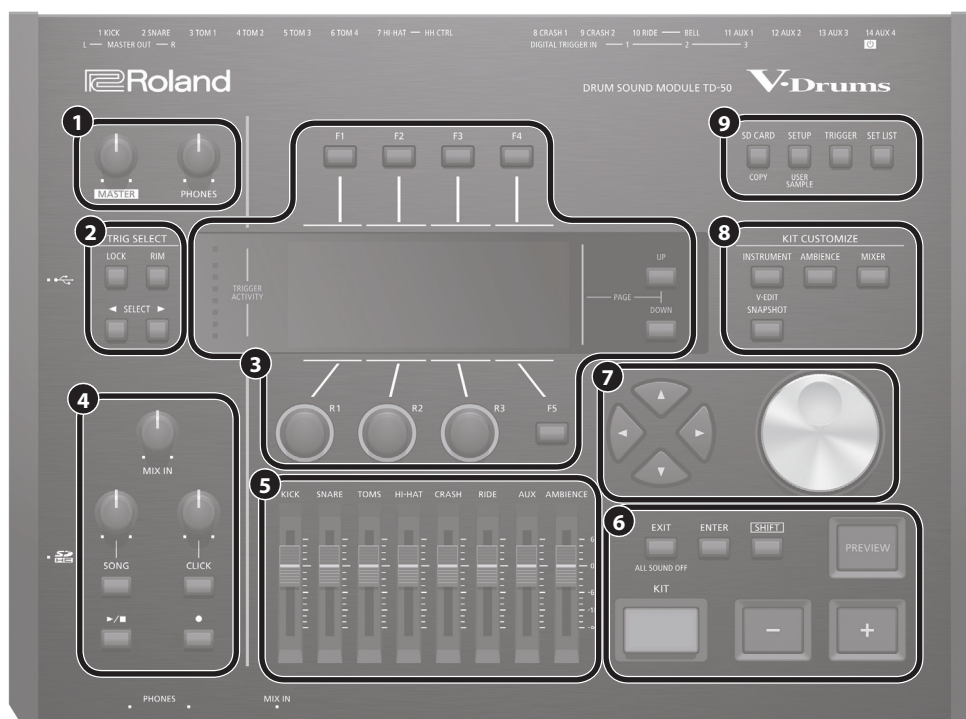

| No. | Controller | Explanation | Page |
|-------------------------------------|--|---|----------------|
| 1 | [MASTER] knob | Adjusts the volume of the MASTER OUT jacks. | p. 12 |
| | [PHONES] knob | Adjusts the volume of the headphones connected to the PHONES jacks. | p. 12 |
| 2 | TRIG SELECT | | |
| | [LOCK] button | If you press the [LOCK] button so its indicator is lit, the pad for which settings are being made will remain selected even if you strike a pad. | p. 20 |
| | [RIM] button | When using a pad that provides rim support, this button specifies whether you're making settings for the head or the rim. In the case of a pad that supports three-way triggering, this button switches between the head, rim, and bell. | |
| | SELECT [◀] [▶] buttons | Select the pad (trigger input number) for which to make settings. | |
| [F1]–[F5] buttons (function button) | These buttons change their function depending on the indication in the display. Use them to switch the tabs that are shown in the upper part of the display, or to specify the function that is shown in the upper or lower part of the display. | p. 12 | |
| [R1]–[R3] knobs (rotary knobs) | The functions of these knobs changes depending on the indication in the display. They adjust the values that are shown in the lower part of the display. | | |
| PAGE [UP] [DOWN] buttons | By pressing the PAGE [UP] [DOWN] buttons when they are lit, you can switch pages in the screen. | | |
| TRIGGER ACTIVITY indicator | This lights when a trigger signal is received from a pad (a signal indicating that the pad is struck). This lets you check whether the pad is connected correctly. | | – |
| 4 | Display | | – |
| | [MIX IN] knob | Adjusts the volume that is input to the front panel and rear panel MIX IN jacks. | – |
| | [SONG] knob | Adjusts the volume of the song (audio file) (This does not affect the sound of an internal song's drum performance, nor the sound of a recorded drum performance). | – |
| | [SONG] button | Accesses the SONG screen. Press this when you want to play back a song or recorded data, or when you want to make song-related settings. | p. 14 |
| | [CLICK] knob | Adjusts the volume of the click. | p. 13 |
| | [CLICK] button | Allows you to sound the click, or to make settings for the tempo or click. You'll also press this for rhythm training. | p. 13 p. 16 |
| | [▶/■] button | Plays/stops the song or the recorded data. | p. 13 |
| 5 | [●] button | Press this when you want to record your performance. | p. 17 |
| | Faders | Adjust the volume of the kick, snare, hi-hat, other percussion instruments, and ambience. | p. 12 |
| 6 | [KIT] button | Accesses the DRUM KIT screen. | p. 13 |
| | [–] [+] buttons | Use these buttons to switch drum kits or to edit values. | p. 12 |
| | [EXIT] button | Press this once to return to the next higher screen level. If you press it repeatedly, you'll eventually return to the DRUM KIT screen. By holding down the [SHIFT] button and pressing the [EXIT] button, you can stop (mute) all currently-playing sound (ALL SOUND OFF (p. 13)). This is a convenient way to stop numerous loop phrases in a single operation. | p. 12 |
| | [ENTER] button | Press this to confirm a value or execute an operation. | p. 12 |
| | [SHIFT] button | This button is used in conjunction with other buttons. The function of other buttons changes while this button is held down. | – |
| | [PREVIEW] button | This button auditions an instrument. The volume changes depending on how strongly you strike the button. You can use the SELECT [◀] [▶] buttons to select a trigger input number, and use this button to audition the sound even if no pads are not connected to the TD-50. | p. 20 |
| 7 | [▲] [▼] [◀] [▶] buttons (cursor buttons) | Move the cursor. | p. 12 |
| | Dial | This dial functions like the [+] and [–] buttons. Use it to scroll quickly or make large changes in edited values. | p. 12 |

| No. | Controller | Explanation | Page |
|-----|----------------------|---|-------|
| 8 | KIT CUSTOMIZE | | |
| | [INSTRUMENT] button | Allows you to specify an instrument (sound). By holding down the [SHIFT] button and pressing the [INSTRUMENT] button, you can move directly to the instrument edit (V-EDIT) page. | p. 19 |
| | [AMBIENCE] button | Allows you to specify the size and resonance of the room in which the drums are being played. | p. 22 |
| | [MIXER] button | Allows you to specify the volume, pan, multi-effect, equalizer, and compressor settings for each pad. | p. 22 |
| | [SNAPSHOT] button | Temporarily saves the currently-edited drum kit, allowing you to compare it with the current settings or return to previous settings (snapshot function). | p. 24 |
| 9 | [SD CARD] button | Allows you to perform SD card operations such as saving or loading data. By holding down the [SHIFT] button and pressing the [SD CARD] button, you can copy the settings of a drum kit or instrument (p. 31). | p. 39 |
| | [SETUP] button | Allows you to make settings for functions that apply to the entire TD-50, such as output-destination settings (output assign) and MIDI settings. By holding down the [SHIFT] button and pressing the [SETUP] button, you can use the user sample function (p. 27) which allows you to import user samples. | p. 42 |
| | [TRIGGER] button | Allows you to make trigger parameter settings. | p. 35 |
| | [SET LIST] button | Allows you to create a set list, or to switch drum kits in the order specified by a set list. | p. 33 |

Side Panel/Front Pane

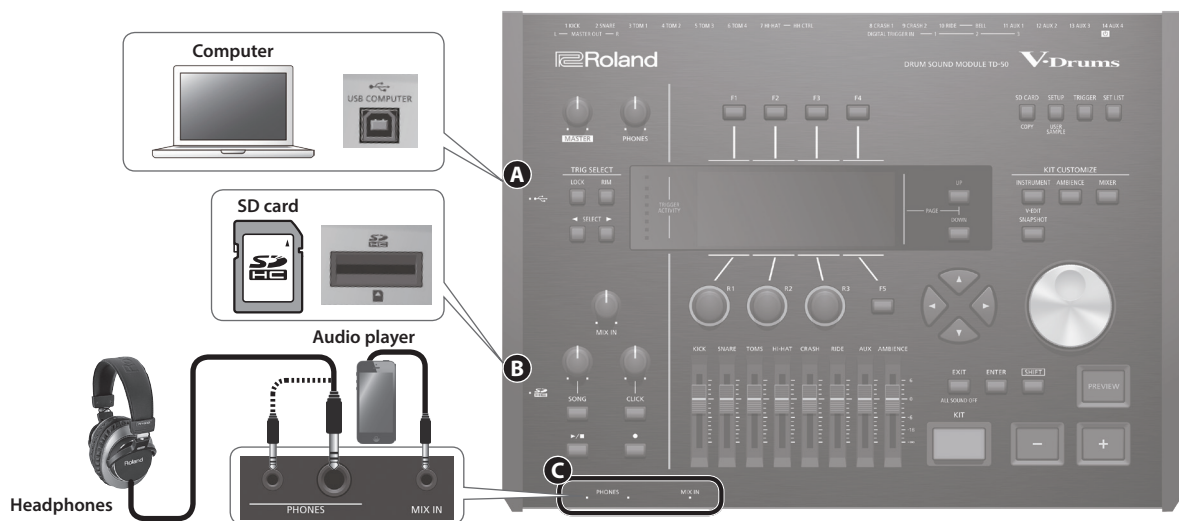

| No. | Jack | Explanation | Page |
|-----|-------------------|--|----------------|
| A | USB COMPUTER port | Use a USB cable to connect the TD-50 to your computer. You can use DAW software to record your TD-50 performance as audio or MIDI, and you can play back sound from your computer through the TD-50. | p. 30 |
| B | SD card slot | Insert a commercially available SD card (SDHC cards (up to 32 GB) are supported). You can store songs or TD-50 data on the SD card. You can also use a card to load user samples or to export a recorded song. Before using an SD card for the first time, you must format it on the TD-50 (p. 41). * Never turn off the power or remove the SD cards while the screen indicates "Processing..." | p. 17 p. 39 |
| C | PHONES jacks | Connect your headphones here. Even if headphones are connected, sound is output from the various output jacks. | - |
| | MIX IN jack | Connect your audio player (smartphone) or other audio playback device here. | - |

Bottom Panel

Mounting the TD-50 on the stand

You can attach the TD-50 to a drum stand by using the sound module mounting plate included with the drum stand (sold separately: MDS series).

Using the screws on the bottom of the TD-50, attach it as shown in the illustration.

- * Do not use any screws other than the screws from the bottom of the TD-50. Doing so will cause malfunctions.
- * When turning the unit over, be careful so as to protect the buttons and knobs from damage. Also, handle the unit carefully; do not drop it.

MEMO

The All Purpose Clamp (APC-33; sold separately) can be attached to a pipe of 10.5–28.6 mm radius in case you want to mount the TD-50 on a cymbal stand or other such stand.

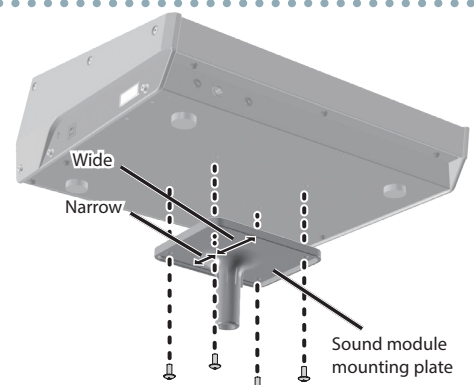

Rear Panel (Connect Your Equipment)

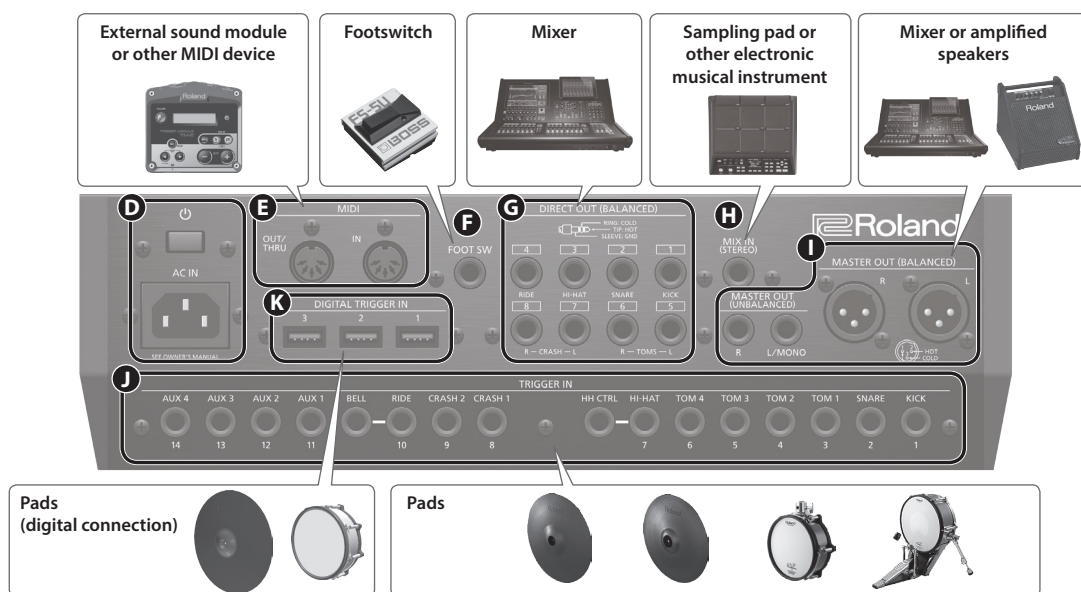

| No. | Jack | Explanation | | |
|-----|--|--|---|--|
| D | [⏻] switch AC IN jack | Press this switch to turn it on/off. Connect the included AC power code to this inlet. | | |
| E | MIDI connectors | Use these connectors to connect an external sound module or other MIDI device. | | |
| F | FOOT SW jack | You can connect a footswitch (BOSS FS-5U, FS-6; sold separately) here and use it to control various things. | | |
| G | DIRECT OUT (BALANCED) jacks | Connect these to your mixer. Use the [SETUP] button to specify the DIRECT OUT 1–8 jack from which each instrument is output. | * Pin assignment of the DIRECT OUT (BALANCED) jacks | |
| H | MIX IN (STEREO) jack | Connect this to an electronic musical instrument such as a sampling pad. | | |
| I | MASTER OUT (BALANCED) jacks MASTER OUT (UNBALANCED) jacks | Connect these to your mixer, amplified speakers, or recording device. If you want to output in mono, connect only the L/MONO jack of the MASTER OUT (UNBALANCED) jacks. | * Pin assignment of the MASTER OUT (BALANCED) jacks | |
| J | TRIGGER IN jacks | Connect cymbal, hi-hat, kick, and other pads here. * If connecting a dual trigger type pad, use a stereo (TRS) cable. | | |
| K | DIGITAL TRIGGER IN ports | Connect pads that support digital connection (e.g., PD-140DS or CY-18DR) here. | | |

Settings for pads that support digital connection

The first time that a pad that supports digital connection is connected to a DIGITAL TRIGGER IN port, the following screen appears.

Following the instructions in the screen, make settings to specify the trigger input to which the connected pad should be assigned.

* If you specify the same trigger input as a pad that is connected to a TRIGGER IN jack, the pad that's connected to that TRIGGER IN jack won't produce sound.

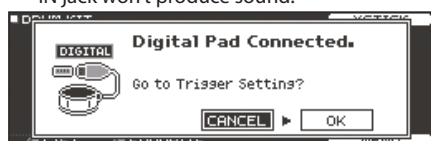

Reference

For details on pad settings, refer to "Specifying a Digitally-Connected Pad" (p. 35).

1. Select "OK" and press the [ENTER] button.

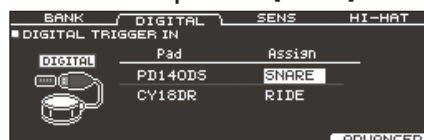

2. Use the cursor buttons to select the pad that you want to specify, and use the [-] [+] buttons or the dial to specify the assignment.

When you select a pad, the FUNC button of the selected pad blinks.

(Setting example)

| Pad | Assign |
|---------|--------|
| PD140DS | SNARE |
| CY18DR | RIDE |

* You can't specify multiple instances of the same assignment.

3. Press the [KIT] button to return to the DRUM KIT screen.

* To prevent malfunction and equipment failure, always turn down the volume, and turn off all the units before making any connections.

Turning the Power On/Off

- * Once everything is properly connected (p. 9), be sure to follow the procedure below to turn on their power. If you turn on equipment in the wrong order, you risk causing malfunction or equipment failure.
- * Before turning the unit on/off, always be sure to turn the volume down. Even with the volume turned down, you might hear some sound when switching the unit on/off. However, this is normal and does not indicate a malfunction.

Turning the power on

1. Minimize the volume of the TD-50 and the connected devices.
2. Press the TD-50's [⏻] switch.

When you turn the TD-50 on, the following screen appears.

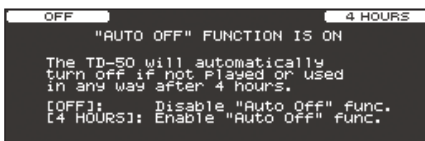

In this screen you can enable or disable the AUTO OFF function.

| Button | Explanation |
|-----------------------|---|
| [F1] (OFF) Button | The power does not turn off automatically. |
| [F4] (4 HOURS) Button | When four hours have elapsed without any pad being struck or any operation being performed, the unit will turn off automatically. |

If the AUTO OFF function is set to "OFF," this screen won't appear.

MEMO

If a pad that supports digital connection is connected, the pad setting screen might appear. For details, refer to "Settings for pads that support digital connection" (p. 9).

3. Power-on the connected devices, and adjust the volume.

Turning the power off

NOTE

Settings that you edit on the TD-50 are saved when you turn off the unit. Be sure to turn off the unit by pressing the [⏻] switch.

1. Minimize the volume of the TD-50 and the connected devices.
2. Turn off the power to the connected devices.
3. Press the TD-50's [⏻] switch.

The screen will indicate "Please wait. Now saving...," and the unit will turn off when the settings have been saved.

- * If you need to turn off the power completely, first turn off the unit, then unplug the power cord from the power outlet. Refer to "To completely turn off power to the unit, pull out the plug from the outlet" (Quick Start).

Making the Power Automatically Turn off After a Time (AUTO OFF)

The power to this unit will be turned off automatically after a predetermined amount of time has passed since it was last used for playing music, or its buttons or controls were operated (AUTO OFF function).



If you do not want the power to be turned off automatically, disengage the AUTO OFF function.

- * To restore power, turn the power on again.

1. Press the [SETUP] button.
2. Use the PAGE [UP] [DOWN] buttons and the function buttons to select "AUTO OFF."

The AUTO OFF screen appears.

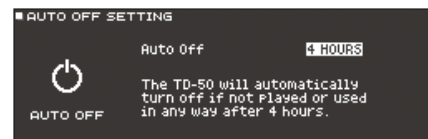

3. Use the [-] [+] buttons or the dial to specify the setting of the auto-off function.

| Value | Explanation |
|---------|---|
| OFF | The power does not turn off automatically. |
| 4 HOURS | When four hours have elapsed without any pad being struck or any operation being performed, the unit will turn off automatically. |

4. Press the [KIT] button to return to the DRUM KIT screen.

MEMO

If the auto-off function is set to "4 HOURS," the message "WARNING: AUTO OFF, The TD-50 will turn off in 30 min." will appear 30 minutes before turning the TD-50 off.

Making Hi-hat Settings

If you're using the VH-13 or VH-11 V-hi-hat, adjust the offset on the TD-50.

This adjustment is required for pedal movements such as open or close to be detected correctly.

Settings for the VH-13

1. Press the [TRIGGER] button.
2. Press the PAGE [UP] button to access page 1 (TRIG BASIC).
3. Press the [F4] (HI-HAT) button.

The TRIGGER HI-HAT screen appears.

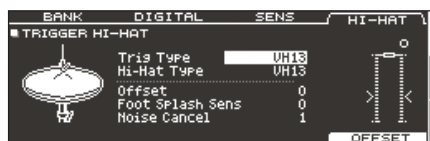

4. Use the [-] [+] buttons or the dial to set the Trig Type to "VH13."
5. Press the [F5] (OFFSET) button.

The VH OFFSET ADJUSTMENT screen appears.

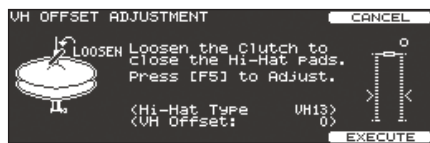

6. Loosen the clutch screw of the top hi-hat and let it sit on the bottom hi-hat.
 - * Do NOT touch the hi-hats or the pedal.
7. Press the [F5] (EXECUTE) button.

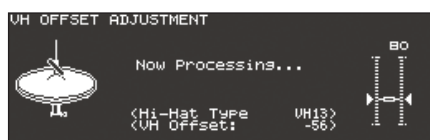

The "VH Offset" parameter is set automatically (approx. 3 seconds). The [TRIGGER] button stops flashing and remains lit.

8. Press the [KIT] button to return to the DRUM KIT screen.

Reference

If you need, make further adjustments to the parameters, refer to "Data List (PDF)."

Settings for the VH-11

1. After making the hi-hat settings, release your foot from the pedal, and while keeping your foot off the pedal, turn on the power of the TD-50.
2. Loosen the clutch screw and let the hi-hat rest naturally on the motion sensor unit.
3. Press the [TRIGGER] button.
4. Press the PAGE [UP] button to access page 1 (TRIG BASIC).
5. Press the [F4] (HI-HAT) button.
6. Use the [-] [+] buttons or the dial to set the Trig Type to "VH11."
7. While reading the meter displayed on the right side of the TD-50's screen, adjust the offset with the VH-11's VH offset adjustment screw.

Adjust the offset so that the  appear in the meter.



8. Press the [KIT] button to return to the DRUM KIT screen.

Reference

If you need, make further adjustments to the parameters, refer to "Data List (PDF)."

Basic Operation

Switching tabs and specifying functions ([F1]–[F5] buttons, [R1]–[R3] knobs)

You can use the [F1]–[F5] buttons to switch the tabs that are shown at the top of the display, or specify the functions that are shown at the top and bottom of the display.

You can also use the [R1]–[R3] knobs to change the values that are shown at the bottom of the display.

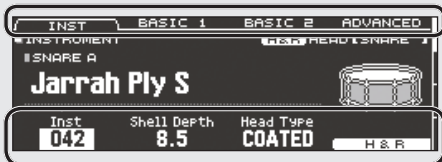

Switching pages (PAGE [UP] [DOWN] buttons)

Use the PAGE [UP] [DOWN] buttons to switch pages in the screen.

In screens where you can switch pages, the PAGE [UP] [DOWN] buttons are lit, and in the right side of the display there is an indication of which page you are in.

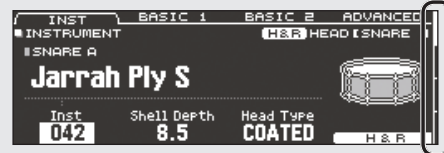

Adjusting the overall volume ([MASTER] knob, [PHONES] knob)

Use the [MASTER] knob to adjust the volume that is output from the MASTER OUT jacks. Use the [PHONES] knob to adjust the headphone volume.



Adjusting the volume balance of each pad (faders)

Use the faders to adjust the volume balance of the entire TD-50.

By using the mixer (p. 22), you can adjust the volume balance of the pads in each kit. Mixer settings can be saved for each individual kit.

You can adjust the following trigger inputs and volumes.

| Fader | Explanation |
|----------|-------------|
| KICK | KICK |
| SNARE | SNARE |
| TOMS | TOM1–4 |
| HI-HAT | HI-HAT |
| CRASH | CRASH1, 2 |
| RIDE | RIDE |
| AUX | AUX1–4 |
| AMBIENCE | AMBIENCE |

Editing a value ([–] [+] buttons/dial)

To edit the value that's highlighted by the cursor, use the dial or the [–] [+] buttons.

If you operate these while holding down the [SHIFT] button, the value changes more quickly.

MEMO

If you hold down the [+] button and press the [–] button, the value will increase rapidly. If you hold down the [–] button and press the [+] button, the value will decrease rapidly.

Moving the cursor (cursor buttons)

Cursor refers to the highlighted characters indicating an on screen parameter that can be set. When there is more than one possibility within the screen, use the cursor buttons to move it.

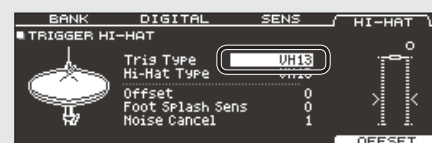

Returning to the previous screen ([EXIT] button)

When you want to return to the previous screen, press the [EXIT] button.

Confirming an operation ([ENTER] button)

Press this button to finalize a value or confirm an operation.

Performing

Selecting a Drum Kit

1. Press the [KIT] button.

The DRUM KIT screen appears.



2. Use the [-] [+] buttons or dial to select a drum kit.

About the DRUM KIT screen

This is the TD-50's main screen; it will appear when you press a [DRUM KIT] button.

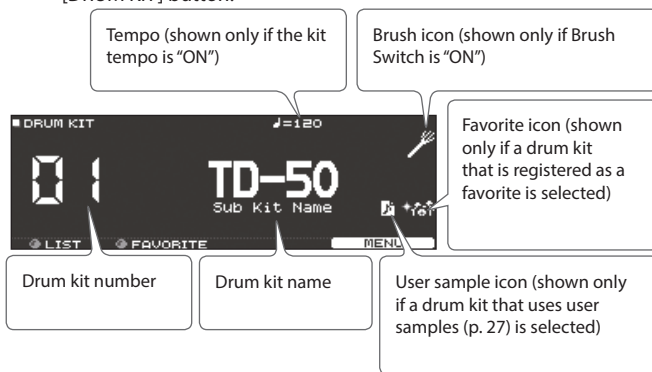

Selecting a Drum Kit from the List

In the DRUM KIT screen, turn the [R1] (LIST) knob; KIT LIST appears, allowing you to select a drum kit from the list.

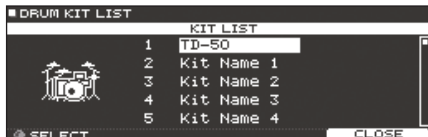

Cross-Stick Function

When playing using a pad that's connected to a TRIGGER IN jack

Each time you press the [F4] (XSTICK) button, you'll switch between sounding and not sounding the cross-stick sound (p. 6) from the snare pad.



When playing using a pad that supports digital connection and cross-stick technique (such as the PD-140DS)

If you assign the trigger input to snare (p. 9), cross-stick technique (p. 6) will always be available.

In this case, the XSTICK icon is not shown in the screen.

Stopping All Currently Played Sounds (ALL SOUND OFF)

Here's how to stop the currently-playing drum performance sounds and user samples (p. 27).

* The effect reverberation, the song, and the click do not stop.

1. If you want to stop the currently-playing performance sounds, hold down the [SHIFT] button and press the [EXIT] button.

Reference

You can also stop all currently-playing performance sounds by using a pad or footswitch (p. 44).

Playing with the Click

Turning the click on/off

1. Press the [CLICK] button.

The CLICK screen appears.

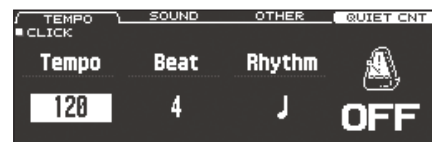

2. Press the [F1] (TEMPO) button.

3. Press the [F5] button.

The click sounds.

You can adjust the volume of the click using the [CLICK] knob.

4. Press the [F5] button once again.

The click stops.

MEMO

You can also turn the click on/off by holding down the [SHIFT] button and pressing the [CLICK] button.

Reference

You can also output the click only to headphones. For details, refer to (p. 42).

Changing the tempo

1. In the CLICK screen (TEMPO tab), turn the [R1] knob to adjust the tempo.

Reference

You can specify the tempo individually for each drum kit (p. 26).

Changing the beat unit

1. In the CLICK screen (TEMPO tab), turn the [R2] knob to change the time signature.

2. Press the [KIT] button to return to the DRUM KIT screen.

Reference

For other settings, refer to "Data List" (PDF).

Performing Along with a Song

Performing Along with an Audio Player Song

Here's how to connect an audio player (smartphone) to the MIX IN jack, and perform along with a song.

1. Connect an audio player to the MIX IN jack (p. 8, p. 9).
2. Play back the audio player.
3. Turn the [MIX IN] knob to adjust the volume of the song.

Performing Along with a TD-50 Song

The TD-50 contains songs of a wide range of genres. Some internal songs consist only of audio data, and others record a drum performance (MIDI data).

An audio file (WAV or MP3) on an SD card can also be played back as a song.

Here's how to perform along with a song.

1. Press the [SONG] button.

The SONG screen appears.



MEMO

When you select an audio song, the screen shows the SPEED parameter (p. 15).

2. Use the [F1]–[F3] buttons, [-] [+] buttons, or dial to select a song.

| Button | Explanation |
|------------------------|--|
| [F1] (INTERNAL) button | Internal songs |
| [F2] (SD CARD) button | SD card songs |
| [F3] (REC DATA) button | Songs recorded on the TD-50 or on an SD card |

MEMO

- For details on the internal songs, refer to “Data List” (PDF).
- To select a song from within a folder on the SD card, turn the [R2] knob to select the folder.

| Controller | Function |
|----------------------|------------------------------|
| [R2] knob | Moves cursor |
| [◀] button | Exits a folder |
| [▶] button | Enters a folder |
| [F5] (SELECT) button | Confirms the selected folder |

3. Press the [▶/■] button.

The selected song plays.

| Controller | Function |
|-----------------|--|
| [▶/■] button | Play/stop the song |
| [▲] (◀) button | Move to the beginning of the song |
| [▼] (▶) button | Move to the end of the song * |
| [◀] (◀◀) button | Rewind the song * |
| [▶] (▶▶) button | Fast-forward the song * |
| [SONG] knob | Adjust the volume of the song (audio file) |
| [CLICK] knob | Adjust the volume of the click track (p. 15) |

* This might be unavailable depending on the type of song.

Reference

- By outputting an audio file from the SD card as a click track, you can play a click along with the song (p. 15).
- You can connect the TD-50 to your computer and play back sound from your computer. For details, refer to “Specifying the Input for USB Audio” (p. 31).

When transferring files from your computer to an SD card

Audio files can be played back not only from the top level of the SD card drive, but also from within a folder.

- * You can put up to 200 song files in a single folder.
- * Make sure that no single file is larger than 2 GB.

Reference

For details, refer to “SD card folder structure” (p. 40).

Audio files that can be played by the TD-50

| | WAV | MP3 |
|--------------------|------------|------------------|
| Format (extension) | WAV (.wav) | MP3 (.mp3) |
| Sampling frequency | 44.1 kHz | 44.1 kHz |
| Bit rate | 16, 24-bit | 64 kbps–320 kbps |

- * File names or folder names that contain more than 16 characters are not shown correctly. Files and folders using double-byte characters are also not supported.

Repeatedly Playing a Specified Region (A-B Repeat)

You can repeat a portion of the song.

- * You can't specify A-B repeat for an internal drum performance song or for a recorded song (REC DATA).

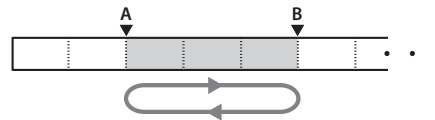

1. Select and play a song.
2. In the SONG screen, press the [F4] (A-B) button at the location where you want to start repeating.

The character “A” appears.



MEMO

You can use the [◀] (◀◀)/[▶] (▶▶) buttons to move backward or forward in five-second steps. Hold down a button to rewind or fast-forward.

3. At the location where you want to stop repeating, press the [F4] (A-B) button.

The character “B” appears, and the region of the song between “A” and “B” plays repeatedly.



Press the [F4] (A-B RPT) button to return to normal playback.

Changing the Settings of Each Song

Here you can specify the song's volume, playback method, and playback speed.

1. In the SONG screen, select a song (p. 14).
2. Edit the song settings.

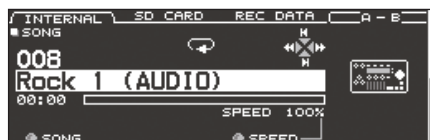

| Knob | Explanation |
|--------------------|--|
| [R1] (SONG) knob | Selects a song. |
| [R2] (FOLDER) knob | When playing back a song from the SD card, selects a folder on the SD card (p. 14). * Shown in the SD CARD tab. |
| [R3] (SPEED) knob | Changes the song's playback speed. * When you switch songs, this returns to 100%. Depending on the type of song, this might not be available. |

SONG INFO/FUNC screen (press the [DOWN] button)

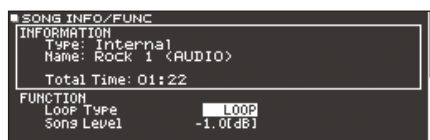

| Parameter | Value | Explanation |
|-------------------|----------------|--|
| Loop Type | ONE SHOT | Play back only once and then stop. |
| | LOOP | Play repeatedly. |
| Song Level | | Song volume |
| Click Track Level | -INF~+6.0 [dB] | Click track volume * Only if there is a click track corresponding to the song |

Viewing song information

1. In the SONG screen, select a song (p. 14).
2. Press the PAGE [DOWN] button.
The SONG INFO/FUNC screen appears.

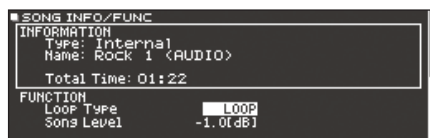

| Display | Explanation |
|------------|---|
| Type | Song type |
| Name | Song name |
| Folder | Song save location |
| | In the case of an SD card, the save location on the SD card is shown. |
| Total Time | Song playback time * Not shown for songs containing only a drum performance. |

3. Press the PAGE [UP] button to return to the SONG screen.

Playing an Audio File as a Click (Click Track)

Separately from the song, you can prepare an audio file (WAV file) and play it back as a click (click track).

Since the click track can play simultaneously with the song, it's convenient when you want a desired click sound to play back along with the song.

* To play back a click track, you must prepare a song and a click audio file in WAV format. MP3 files are not supported.

Preparing a click track audio file

1. Prepare the audio file (WAV file) that you want to play back as a click track.
2. On your computer, edit the file name of the file that you prepared in step 1.
Specify "song file name+_Click" as the name of the audio file that you want to play as the click track.
Example)
If you want the click track to play back along with a song named "TD-50.wav" then you would specify "TD-50_Click.wav" as the name of the click audio file.
3. Save the click audio file in the same level as the song on the SD card (p. 40).
In the case of the example, save "TD-50.wav" and "TD-50_Click.wav" in the same level.

Playing back the click track along with the song

1. In the SONG screen, press the [F2] (SD CARD) button (p. 14).
2. Use the [R2] knob, [-] [+] buttons, or the dial to select the song that you want to play back together with the click track.
In the case of the example, select the song "TD-50.wav."
3. Press the [F5] button to specify "CLICK ON!"



4. Press the [▶/■] button.

The click track plays together with the song playback.

To adjust the volume of the click track, turn the [CLICK] knob.

In the case of the example, you can use the [SONG] knob to adjust the volume of "TD-50.wav" and use the [CLICK] knob to adjust the volume of "TD-50_Click.wav."

MEMO

- To mute the click track, press the [F5] button to specify "CLICK OFF!"
- You can also output the click track only to headphones (p. 42).

Rhythm Training (QUIET COUNT)

The TD-50 provides a “Quiet Count” function that’s an ideal way to develop your sense of tempo.

The Quiet Count function trains your body to keep the tempo. For the first several measures, the click sounds at the specified volume, but for the next several measures the volume decreases, becoming nearly inaudible. This cycle of several measures continues until you stop the function.

1. In the CLICK screen (p. 13), press the [F4] (QUIET CNT) button to start training.

- The click will sound during the first few measures. When you reach the last measure during which the click will sound, the screen will indicate “Ready.”



- When the click stops sounding, the screen indication will change to “Quiet.” Continue striking the pads during this time.



- After the Quiet region, the proportion of your strikes that were played at an accurate tempo are shown as a “%” value.

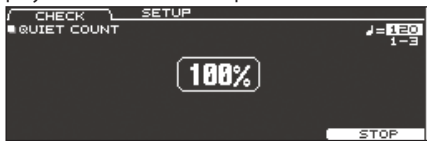

2. To stop training, press the [F5] (STOP) button to return to the CLICK screen.

Quiet Count settings

In the QUIET COUNT screen, press the [F2] (SETUP) button to access the settings screen.



| Parameter | Value | Explanation |
|-----------|--|--|
| Measures | 2, 4, 8, 16 (Measures) | Specify the length (measures) of the interval for which the click will alternate between “Sounding” and “Quiet.” |
| Quiet | Of the measures specified by “Measures,” this setting specifies the length of the measures that will be “Quiet.” | |
| | RANDOM | The length of the Quiet interval will randomly change each time. |
| | 1, 2, 4 | Specifies the length (number of measures) of the Quiet interval. * This setting cannot be longer than half of the Measures value. |

Registering/Recalling Favorite Drum Kits (FAVORITE)

You can register frequently-used drum kits as “favorites” for instant recall.

Registering a favorite

1. Select the drum kit that you want to register (p. 13).
2. In the DRUM KIT screen (p. 13), press the [F5] (MENU) button.
3. Press the PAGE [UP] button to access page 1 (KIT SETTINGS).
4. Press the [F3] (FAVORITE) button.
5. Turn the [R2] knob to turn favorites “ON.”



6. Press the [KIT] button to return to the DRUM KIT screen. Drum kits that are registered as a favorite will show an icon in the DRUM KIT screen.



Recalling a favorite

1. In the DRUM KIT screen, turn the [R2] (FAVORITE) knob. A list of drum kits that are registered as favorites is displayed.

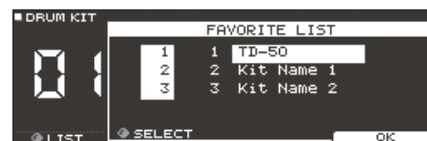

2. Select the drum kit that you want to recall, and press the [F5] (OK) button.

The TD-50 switches to the selected drum kit.

MEMO

To remove “favorite” registration from a drum kit, turn the favorite setting “OFF.”

Recording

Recording a Performance

You can easily record your own performance and play it back.

- * If you want to record on an SD card, you must first insert an SD card (p. 8).

Recording Your Drum Performance

Here's how to record your drum performance.

Recording

1. In the DRUM KIT screen (p. 13), press the [●] button.

The RECORDER screen appears; the TD-50 is in record-standby condition.



MEMO

If you want to record along with a click, sound the click (p. 13).

2. Press the [F5] button to select "DRUM only."

3. Turn the [R1] knob to select the recording destination.

| Display | Explanation |
|-----------|---|
| TEMPORARY | Record onto the TD-50's temporary area (one song). * The recorded data in the TEMPORARY area disappears when you turn off the power. |
| SD#01-99 | Record onto the SD card (99 songs). * You can't select this unless an SD card is inserted in the TD-50. |

MEMO

- If it is OK to overwrite a recording destination that already contains recorded data, turn the [R2] knob to add a check mark to "Overwrite." If the check mark is cleared, previously-recorded data will not be accidentally overwritten.
- Recorded data can be copied (p. 31) or exported (p. 18) to an SD card.

4. Press the [▶/■] button to start recording.

5. Press the [▶/■] button once again to stop recording.

Playback

6. Press the [▶/■] button.

The recorded performance plays back.



MEMO

Recorded data can be viewed in the REC DATA tab. You can also turn the [R1] knob to select another recorded song, and press the [▶/■] button to play it.

7. Press the [▶/■] button to stop playback.

Recording Your Performance Along with a Song

You can record your performance along with a song.

Recording

1. Select the song (audio file) (p. 14).

2. Press the [●] button.

The RECORDER screen appears; the TD-50 is in record-standby condition.

3. Press the [F5] button to select "with SONG."



You can select "with SONG" only for audio file songs.

4. Turn the [R1] knob to select the recording destination.

MEMO

If it is OK to overwrite a recording destination that already contains recorded data, turn the [R2] knob to add a check mark to "Overwrite." If the check mark is cleared, previously-recorded data will not be accidentally overwritten.

5. Press the [▶/■] button to start recording.

The TD-50 starts recording and the song starts playing.

6. Press the [▶/■] button once again to stop recording.

Playback

7. The recorded performance plays back.

You can press the [F5] button to specify whether the drum performance sounds are heard.

- * If you recorded while playing back a click track (p. 15) along with the song, the click track does not play when you play back the recorded performance.

Deleting Recorded Data

Here's how to delete recorded data.

1. In the SONG screen (p. 14), press the [F3] (REC DATA) button.

2. Turn the [R1] knob to select the recorded data that you want to delete.

3. Press the PAGE [DOWN] button.

4. Press the [F3] (DELETE) button.

A confirmation message appears.

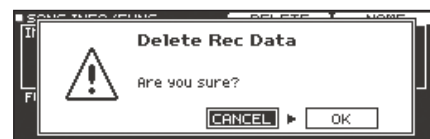

If you decide to cancel, select "CANCEL" and press the [ENTER] button.

5. Select "OK" and press the [ENTER] button.

The recorded data is deleted.

Renaming Recorded Data

Here's how to change the name of recorded data.

1. In the SONG screen (p. 14), press the [F3] (REC DATA) button.
2. Turn the [R1] knob to select recorded data.
3. Press the PAGE [DOWN] button.
4. Press the [F4] (NAME) button.

The SONG NAME screen appears.



5. Edit the name (p. 25).
You can enter up to 16 characters as the song name.
6. Press the [F5] (EXIT) button to exit the SONG NAME screen.

Exporting Recorded Data to an SD Card (SONG EXPORT)

Data that you recorded in internal memory or on an SD card can be exported to an SD card as an audio file (WAV) or SMF data.

1. In the SONG screen (p. 14), press the [F3] (REC DATA) button.
2. Turn the [R1] knob to select the type of export.
3. Press the [F4] (EXPORT) button.

The SONG EXPORT screen appears.

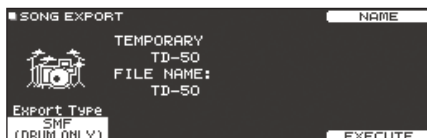

4. Turn the [R1] knob to select the type of export.

| Display | Explanation |
|-----------------|---|
| SMF (DRUM ONLY) | Export the drum performance as SMF. |
| WAV (DRUM ONLY) | Export the sound of the drum performance as an audio file. |
| WAV (DRUM+SONG) | Export the sound of the drum performance and the song as an audio file. * You can't select this for recorded data that was recorded as "DRUM only." |
| ALL (WAV+SMF) | If you recorded as "DRUM only" The drum performance is exported as an audio file and as SMF. If you recorded as "with SONG" Drum performance sounds are exported as an audio file and as SMF, and the drum performance sounds and the sound of the song are exported as an audio file. |

MEMO

You can press the [F4] (NAME) button and assign a name for the exported file.

5. Turn knobs [R2] or [R3] to specify the export settings (only if exporting an audio file).

| Parameter | Explanation |
|------------------|---|
| Export Gain | By pressing the [▶/■] button you can preview-play the recorded data that is produced by the export. While watching the output level meter, adjust the volume of the audio file. Positive (+) values increase the volume.  |
| Post Export Time | In some cases, the reverberation of the last notes might be cut off in the exported audio file. If so, you can increase this value to prevent the reverberation from being cut off. |

* The sound that is output from the MASTER OUT jacks is exported as the audio file. Depending on the routing settings (p. 43), specific sounds might not be exported in some cases.

6. Press the [F5] (EXECUTE) button.

A confirmation message appears.



If you decide to cancel, select "CANCEL" and press the [ENTER] button.

7. Select "OK" and press the [ENTER] button.

The export starts.

The exported data is saved in the "EXPORT folder" (p. 40).

NOTE

Never do the following operations while export is progressing. These operations might cause all recorded data to be lost.

- Turning off the power
- Removing the SD card
- Striking a pad

MEMO

- If exported data of the same name already exists, the message "Overwrite it?" appears. If it is OK to overwrite the data, select "OK" and press the [ENTER] button. If you decide to cancel the operation, select "CANCEL" and press the [ENTER] button; then change the name and export the data.
- If you decide to cancel the export without completing it, press the [F4] (ABORT) button.
- When you export a drum performance as SMF data, the data is exported using the note numbers specified by the drum kit and the MIDI settings in SETUP. For details, refer to "Data List" (PDF).

Customizing a Kit

Saving the settings

On the TD-50, your edits are saved automatically, so you don't have to perform any operation to save the settings. Settings are also saved when you turn off the power.

Editing an Instrument (INSTRUMENT)

Here's how to edit an individual instrumental sound such as the snare drum or kick drum.

The TD-50 lets you reproduce the way in which the sound of an instrument is affected by its shape and size. You can shape your sound in an intuitive way, just as if you were selecting a desired drum head and tuning it, or adding muffling (muting).

You can also apply effects such as mic settings and transients.

Reference

For details on the parameters that can be edited, refer to "Data List" (PDF).

MEMO

An audio file that you created on your computer can be loaded from an SD card into the TD-50, and played as an instrument (p. 27).

1. Press the [INSTRUMENT] button.

The INSTRUMENT screen appears.



* The displayed content and tabs differ depending on the instrument.

2. Select the pad that you want to edit (p. 20).

3. Use the PAGE [UP] [DOWN] buttons and function buttons to select the item that you want to edit.

* The parameters that you can edit depend on the pad and instrument.

4. Use cursor buttons to select a parameter, and use the [-] [+] buttons or the dial to edit the value.

MEMO

For some parameters, you can also use the rotary knobs to edit the value.

5. Press the [KIT] button to return to the DRUM KIT screen.

MEMO

You can copy the settings of an instrument (p. 31).

Selecting an Instrument

1. Press the [INSTRUMENT] button.
2. Press the PAGE [UP] button to access page 1 (INSTRUMENT).
3. Press the [F1] (INST) button.

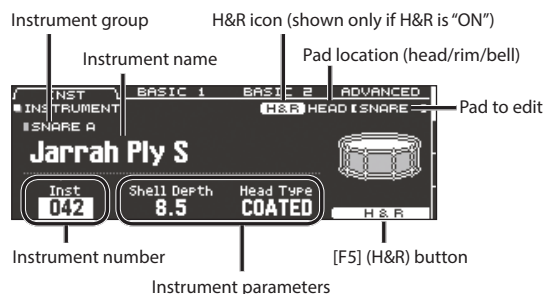

4. Select the pad that you want to edit (p. 20).

5. Turn the [R1] knob to select an instrument.

MEMO

When the cursor is located at "instrument number" or "instrument group," you can press the [ENTER] button to see the instrument list.

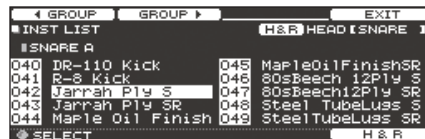

6. Press the [KIT] button to return to the DRUM KIT screen.

Reference

For details on the instruments that you can select, refer to "Data List" (PDF).

Selecting an instrument for each strike location ([F5] (H&R) button)

In a screen where the [F5] (H&R) button is shown, you can choose whether instruments for areas such as the head and rim are selected together as a set (ON) or independently (OFF).

| [F5] (H&R) button | Explanation |
|-------------------|---|
| ON | <p>Instruments for areas such as head and rim are selected as a set.</p> <p>As appropriate for the selected instrument, the recommended instruments are selected as a set.</p> <p>* If the same parameter exists within the instruments that are selected as a set, they are automatically set to the same value.</p> <p>* Depending on the instrument, the same instrument might be selected for all areas such as head and rim.</p> |
| OFF | <p>Instruments are selected individually for each struck area, such as the head and the rim.</p> |

Choosing a Pad to Edit

Choosing by hitting a pad

To edit the settings for a pad, strike that pad to select it.
To select the rim of a pad, strike the rim.

Choosing with the SELECT [◀] [▶] buttons

You can also use the SELECT [◀] [▶] buttons to select the pad (trigger input number) to edit. When using a pad that provides rim support, the [RIM] button lets you choose whether to make settings for the head or for the rim. When using a pad that provides three-way trigger support, this button switches between head, rim, and bell. The [RIM] button is lit if the rim or bell is selected.



Preventing the currently edited pad from changing (Trigger Lock)

If you want to audition your performance sounds while you edit the instruments, you can specify that the currently edited pad does not change even if you strike another pad.

1. Press the [LOCK] button to make it light.

The pad you're editing is locked.

* The pad remains locked even if you use MIDI messages to switch pads.

2. To defeat the lock, press the [LOCK] button to make it go dark.

MEMO

Even if the [LOCK] button is lit, you can use the SELECT [◀] [▶] buttons to change the pad that you're editing.

Auditioning the Sound of a Pad ([PREVIEW] button)

You can press the [PREVIEW] button to audition the sound of the currently selected pad.

The volume changes depending on how strongly you press the button. You can also fix the volume. For details, refer to "Data List" (PDF).

MEMO

- By holding down the [SHIFT] button and pressing [PREVIEW], you can audition a variety of sounds depending on the combination of the currently selected pad and instrument. (For example, you could audition the sound of the snare head's outer circumference, a shallow rim shot, or the hi-hat close sound.)
- By using the SELECT [◀] [▶] buttons to select a trigger input number, you can audition the sound even if that pad is not connected to the TD-50.

Adjusting the Mic Settings (MIC POSITION)

You can edit the mic position and volume for each instrument.

* For some instruments, these settings are not available.

1. Press the [INSTRUMENT] button.
2. Select the pad that you want to edit.
3. Press the PAGE [UP] [DOWN] button to access page 2 (MIC POSITION).



4. Use cursor buttons to select a parameter, and use the [-] [+] buttons or the dial to edit the value.

| Parameter | Value | Explanation |
|--------------------|-----------------------------------|---|
| MIC POS tab | | |
| Mic Position | OUTSIDE4- STANDARD- INSIDE4 | Tonal change caused by mic position |
| ELEMENT tab | | |
| Overhead | -INF+6.0 dB | Volume of overhead mic |
| Room | -INF+6.0 dB | Volume of room mic |
| WIDTH tab | | |
| Mic Width | -5+5 | Spread of the overhead mic and room mic |

Adjusting the Attack and Release (TRANSIENT)

You can adjust the attack and release (transient) for each instrument.

* For some instruments, these settings are not available.

1. Press the [INSTRUMENT] button.
2. Select the pad that you want to edit.
3. Press the PAGE [UP] [DOWN] button to access page 3 (TRANSIENT).

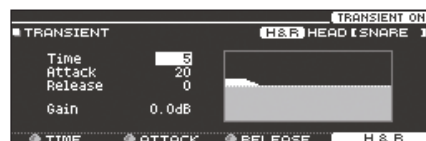

4. Use cursor buttons to select a parameter, and use the [-] [+] buttons or the dial to edit the value.

| Parameter | Value | Explanation |
|-------------|----------------------|---|
| [F4] button | OFF, TRANSIENT ON | Turns the transient effect on/off. |
| Time | 1-10 | Time over which the attack changes |
| Attack | -100+100 | Adjusts the attack |
| Release | -100+100 | Adjusts the release |
| Gain | -12.0+6.0 dB | Adjusts the volume following transient adjustment |

Layering Instruments (SUB INSTRUMENT)

You can layer the main instrument with a sub instrument so that they are heard together. You can also switch between two instruments according to the force of your strike, or vary the balance between them.

1. Press the [INSTRUMENT] button.
2. Select the pad that you want to edit (p. 20).
3. Press the PAGE [DOWN] button to access page 4 (SUB INSTRUMENT).
4. Press the [F1] (SUB INST) button.
The SUB INSTRUMENT screen appears.

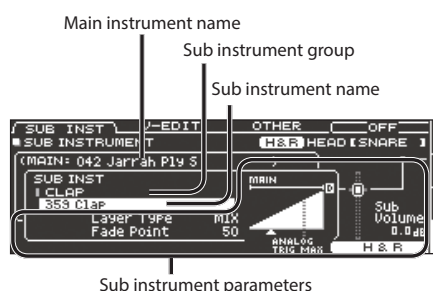

Selecting a sub instrument

5. Move the cursor to the sub instrument or the sub instrument group, and use the [-] [+] buttons or the dial to select a sub instrument.

Turning the sub instrument on/off

6. Press the [F4] button to turn the sub instrument on/off.

Sub instrument settings

7. Use cursor buttons to select a parameter, and use the [-] [+] buttons or the dial to edit the value.

| Parameter | Explanation |
|----------------|--|
| | These parameters specify how the sub instrument will be sounded. |
| MIX | <p>The main instrument (A) and sub instrument (B) always sound together as a layer.</p> |
| FADE1 | <p>The sub instrument (B) is added as a layer only if the strike is stronger than "Fade Point."</p> |
| FADE2 FADE3 | <p>If the strike is stronger than "Fade Point," the sub instrument (B) is added as a layer according to the strength of that strike. FADE2: At 127 or higher, the main instrument (A) and sub instrument (B) are the same volume. FADE3: At 127+32, the main instrument (A) and sub instrument (B) are the same volume (for pads that support digital connection).</p> |
| SWITCH | <p>Strikes weaker than "Fade Point" sound the main instrument (A), and strikes stronger than "Fade Point" switch to sound the sub instrument (B).</p> |
| Fade Point | Specifies the force of the strike at which the sub instrument begins to be sounded. If this is "1," the sub instrument is sounded by a strike of any force. If this is "127" ("127+32" for a pad that supports digital connection), the sub instrument is sounded only by the strongest strike. * This is not available if Layer Type is "MIX." |
| Sub Volume | -INF- +6.0 dB Adjusts the volume of the sub instrument. |

MEMO

The indication of Layer Type is different for a pad that is connected to a TRIGGER IN jack than for a pad that supports digital connection.

For a pad that is connected to a TRIGGER IN jack



For a pad that supports digital connection



Reference

For details on other settings, refer to "Data List" (PDF).

8. Press the [KIT] button to return to the DRUM KIT screen.

Simulating the Ambience of a Performance Space (AMBIENCE)

This simulates the reverberation or acoustics of a location in which you're playing the drums (ambience).

By adjusting settings such as room ambience (the type and size of the room), and reverb (reverberation), you can give your drum sound more naturalness and presence.

Reference

For details on the parameters that can be edited, refer to "Data List" (PDF).

1. Press the [AMBIENCE] button.
2. Use the PAGE [UP] [DOWN] buttons to access the editing screen.

AMBIENCE screen



ROOM screen



REVERB screen



STEREO ENHANCER screen

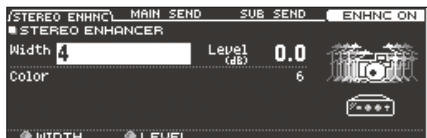

3. Edit the settings of the ambience.
4. Press the [KIT] button to return to the DRUM KIT screen.

Turning ambience on/off

1. Press the [AMBIENCE] button.
2. Press the PAGE [UP] button to access page 1 (AMBIENCE).
3. Press the [F1]–[F3] button to turn the setting on/off.

| Button | Explanation |
|-------------|-------------------------------|
| [F1] button | Turns room ambience on/off. |
| [F2] button | Turns reverb on/off. |
| [F3] button | Turns stereo enhancer on/off. |

MEMO

You can copy ambience settings (p. 31).

Editing the Mixer (MIXER)

Here you can adjust the volume of each pad and apply various effects to the sound.

Reference

For details on the parameters that can be edited, refer to "Data List" (PDF).

1. Press the [MIXER] button.
The Mixer setting screen appears.
2. Select the pad that you want to edit (p. 20).
3. Edit the mixer settings.
4. Press the [KIT] button to return to the DRUM KIT screen.

Specifying the Volume and Pan of Each Pad

You can adjust the volume and pan (stereo position) for each pad.

1. Press the [MIXER] button.
2. Press the PAGE [UP] button to access page 1 (MIXER VOLUME).

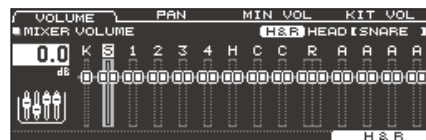

3. Press one of the [F1] (VOLUME)–[F4] (KIT VOL) buttons to select the item that you want to set.
4. Select the pad that you want to edit (p. 20).
You can also use the cursor buttons to make a selection.
5. Use the [–] [+] buttons or the dial to edit the value.

| Parameter | Value | Explanation |
|---|-------------|---|
| [F1] (VOLUME) button | | |
| Volume | -INF+6.0 dB | Volume of each pad |
| [F2] (PAN) button | | |
| Pan | L30–CTR–R30 | Stereo position of each pad |
| [F3] (MIN VOL) button | | |
| Pad Minimum Volume* | 0–15 | Minimum volume of each pad This lets you increase the volume of the softest hits while preserving the volume of the strongest hits. This can make it easier to hear ghost notes on the snare or legato notes on the ride cymbal. |
| Pad Maximum Volume* | -5–0 | Maximum volume of each pad This lets you decrease the volume of the strongest hits while preserving their nuances. You can limit the volume while preserving the nuances of the strongest hits. |
| * This is available only for pads that support digital connection and for input from the MIDI IN connector. | | |
| [F4] (KIT VOL) button | | |
| Kit Volume | | Drum kit volume |
| Pedal HH Volume | -INF+6.0 dB | Pedal hi-hat volume |
| XStick Volume | | Cross-stick volume |

* You can use the cursor [▲] [▼] buttons to switch between selecting the Pad Minimum Volume and Pad Maximum Volume.

MEMO

- If you press the [F5] (H&R) button to turn it “ON,” you can simultaneously make settings for the head area and rim area, etc.
- You can also set “Kit Volume” in the KIT SETTINGS screen (VOLUME tab).
- You can copy the MIXER VOLUME and MIXER PAN settings (p. 31).

Applying Effects

For each pad, you can adjust the way in which its volume changes (pad compressor) and adjust its tone (pad equalizer), or apply up to three effects to the entire drum kit (multi-effect).

Reference

For details on the parameters that can be edited, refer to “Data List” (PDF).

1. Press the [MIXER] button.
2. Use the PAGE [UP] [DOWN] buttons to access the edit screen.

PAD EQ screen

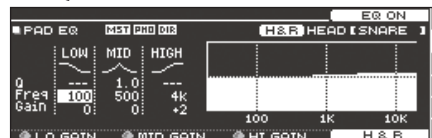

PAD COMP (COMPRESSOR) screen

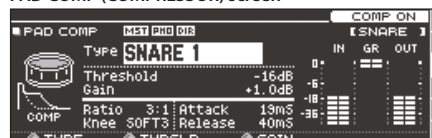

MFX (MULTI EFFECT) screen

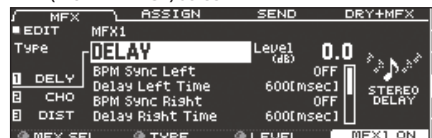

3. Edit the effect settings.

Turning effects on/off

1. Press the [MIXER] button.
2. Use the PAGE [UP] [DOWN] buttons to access the edit screen.
3. Press a function button to turn the setting on/off.

| Screen | Button | Explanation |
|------------------------------|-------------|--|
| PAD EQ screen | [F4] button | Turns pad equalizer on/off. |
| PAD COMP (COMPRESSOR) screen | [F4] button | Turns pad compressor on/off. |
| MFX (MULTI EFFECT) screen | [F5] button | Turns on/off the multi-effect 1–3 selected by the [R1] knob. |

MEMO

You can copy pad equalizer, pad compressor, and multi-effect settings (p. 31).

Adjusting the Overall Sound (MASTER COMPRESSOR/MASTER EQ)

You can make settings for the stereo compressor/limiter (master comp) and four-band parametric equalizer (master EQ) that are applied to the final stage of the master output.

- * The master comp and EQ effect is not applied to the DIRECT OUT jacks.
- * If the routing setting (p. 43) Master Out is set to “DIRECT,” master compressor and master EQ effects are not applied to the sound that is output from the MASTER OUT jacks.

Reference

For details on the parameters that can be edited, refer to “Data List” (PDF).

Using the master comp

- When used as a compressor, this allows you to raise the overall loudness of the drums by compressing brief peaks in the sound. This lets the sound project better, without being buried in the mix by the other instruments.
- When used as a comp-limiter, this lets you increase the recording level while limiting the maximum input to the recording device.
- If you’re using a small monitor amp, you can use this effect as a limiter so that the peaks of the drum sound are limited, making the sound less likely to distort.

Using the master EQ

- This lets you adjust the tonal character by boosting or cutting each of the four bands (LOW/MID1/MID2/HIGH).
- You can also use this to make compensations in the tone when using the master comp.

1. Press the [MIXER] button.
2. Use the PAGE [UP] [DOWN] buttons to access the edit screen.

MASTER COMP screen

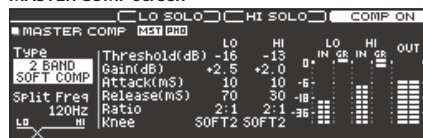

MASTER EQ screen

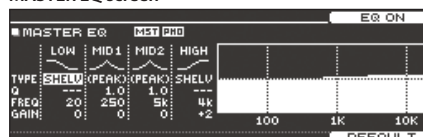

3. Edit the effect settings.

Turning the master compressor and master EQ on/off

1. Press the [MIXER] button.
2. Use the PAGE [UP] [DOWN] buttons to access the edit screen.
3. Press a function button to turn the setting on/off.

| Screen | Button | Explanation |
|--------------------|-------------|---------------------------|
| MASTER COMP screen | [F4] button | Turns master comp on/off. |
| MASTER EQ screen | [F4] button | Turns master EQ on/off. |

Comparing with or Reverting to the Unedited Drum Kit (SNAPSHOT)

You can temporarily save the currently-edited drum kit, and compare it with the current settings or revert back to it (snapshot).

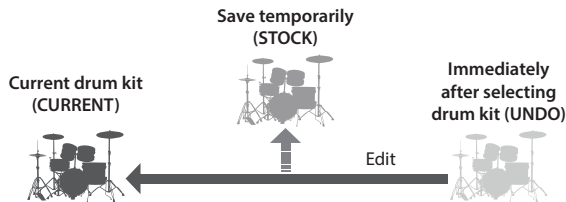

1. Select the drum kit that you want to edit.

When you select a drum kit, the data of the selected drum kit is stored in “UNDO.”

2. When you want to temporarily save the settings of the currently-edited drum kit, press the [SNAPSHOT] button.

The SNAPSHOT screen appears, and the current drum kit (CURRENT) is selected.



3. Press the [F5] (SAVE) button.

The current drum kit settings are saved in STOCK.

MEMO

By holding down the [SHIFT] button and pressing the [SNAPSHOT] button, you can save the current drum kit settings in STOCK without entering the SNAPSHOT screen.

4. Press the [EXIT] button to exit the SNAPSHOT screen, and edit the drum kit.

* When you switch drum kits, the settings saved in STOCK are deleted.

5. Press the [SNAPSHOT] button.

6. Use the [F1]–[F3] buttons to switch between the saved drum kits, and play them to compare.

| Button | Explanation |
|-----------------------|---|
| [F1] (CURRENT) button | Current drum kit settings |
| [F2] (STOCK) button | Drum kit settings saved in STOCK |
| [F3] (UNDO) button | Settings immediately after selecting the drum kit |

7. If you want to return the current drum kit settings to the state immediately after selecting a drum kit or STOCK, press the [F2] or [F3] button to select the drum kit settings to which you want to return.

If you want to continue with the current drum kit settings, press the [KIT] button to return to the DRUM KIT screen.

8. Press the [F4] (RESTORE) button.

A confirmation message appears.



If you decide to cancel, select “CANCEL” and press the [ENTER] button.

9. Select “OK” and press the [ENTER] button.

The current drum kit settings return to the settings of the drum kit that you selected in step 7.

10. Press the [KIT] button to return to the DRUM KIT screen.

Editing a Drum Kit (MENU)

Here’s how to make settings such as the volume of the drum kit and the illumination color of the controls.

Reference

For details on the parameters that can be edited, refer to “Data List” (PDF).

1. In the DRUM KIT screen (p. 13), press the [F5] (MENU) button.

The menu screen appears.



2. Edit the settings of the drum kit.

3. Press the [KIT] button to return to the DRUM KIT screen.

MEMO

You can copy a drum kit (p. 31).

Setting the Volume

Here’s how to set the volume of the drum kit.

1. In the DRUM KIT screen (p. 13), press the [F5] (MENU) button.

2. Press the PAGE [UP] button to access page 1 (KIT SETTINGS).

The KIT SETTINGS screen appears.

3. Press the [F1] (VOLUME) button.

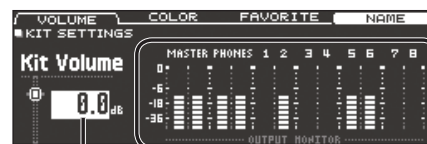

Volume of the drum kit

Output monitor

Shows the output level from the MASTER OUT jacks, PHONES jacks, and DIRECT OUT jacks.

4. Use the [-] [+] buttons or the dial to edit the value.

| Parameter | Value | Explanation |
|------------|-------------|------------------------|
| Kit Volume | -INF+6.0 dB | Volume of the drum kit |

MEMO

You can also set Kit Volume in the MIXER DRUM KIT VOLUME screen (KIT VOL tab) of the MIXER (p. 22).

Specifying the Illumination Color of the [KIT] Button and Knobs

For each kit, you can change the illumination color of the [KIT] button and knobs. This provides a useful way to distinguish between drum kits; for example you could assign different colors to drum kits of different genres, or use the color as a guideline when editing instruments.

1. In the KIT SETTINGS screen, press the [F2] (COLOR) button.



2. Use the cursor buttons, [-] [+] buttons, or the dial to select the illumination color.

| Value | 1-10 |
|-------|------|
|-------|------|

Renaming the Drum Kit

Here's how to rename the currently selected drum kit.

1. In the KIT SETTINGS screen, press the [F4] (NAME) button. The DRUM KIT NAME screen appears.



2. Edit the name.

You can enter a kit name (upper line) of up to 12 characters, and a sub-name (lower line) of up to 16 characters.

| Controller | Explanation |
|-----------------------|---|
| Cursor buttons | Move the cursor to the character that you want to change. |
| [-] [+] buttons, dial | Change the character. |
| [R1] (ABC) knob | Select uppercase characters. |
| [R2] (abc) knob | Select lowercase characters. |
| [R3] (123) knob | Select numerals. |
| [F3] (INSERT) button | Insert a space at the cursor location. |
| [F4] (DELETE) button | Delete the character at the cursor location. |

3. Press the [F5] (EXIT) button to exit the DRUM KIT NAME screen.

Performing with Brushes

You can specify whether you're performing with sticks or with brushes.

- * "Playing with brushes" function will be enabled in the future. The information will be announced at the Roland website. <http://www.roland.com/support/>

1. In the DRUM KIT screen (p. 13), press the [F5] (MENU) button.
2. Press the PAGE [UP] [DOWN] button to access page 2 (KIT SETTINGS 2).
3. Press the [F1] (BRUSH) button.
4. Use the [-] [+] buttons or the dial to edit the value.

| Parameter | Value | Explanation |
|--------------|-------|------------------------------|
| Brush Switch | OFF | When performing with sticks |
| | ON | When performing with brushes |

If Brush Switch is "ON," the brush icon is shown in the DRUM KIT screen.



MEMO

Brush performance is available in the following cases.

- When you select an instrument that supports brush performance, and assign it to the head of the snare.
- When you connect a mesh pad to the TRIGGER IN jack (SNARE), or connect a pad that supports digital connection to a DIGITAL TRIGGER IN port, and set assign to "SNARE."

Specifying the Tempo for Each Kit

When you select a drum kit, the tempo you specify here is automatically applied.

1. In the DRUM KIT screen (p. 13), press the [F5] (MENU) button.
2. Press the PAGE [UP] [DOWN] button to access page 2 (KIT SETTINGS 2).
3. Press the [F2] (TEMPO) button.
4. Use the [-] [+] buttons or the dial to edit the value.

| Parameter | Value | Explanation |
|-----------|--------|---|
| Kit Tempo | OFF | Use a common tempo (p. 13) for the entire TD-50 The tempo does not change when you switch drum kits. |
| | ON | Individually specify a tempo for each drum kit When you select a drum kit whose Kit Tempo setting is "ON," the tempo of that drum kit is applied to the current tempo. |
| Tempo | 20–260 | Tempo specified for each drum kit |

If you select a drum kit whose Kit Tempo is "ON," the tempo is shown in the DRUM KIT screen.



If the tempo of an individual drum kit is set differently than the overall tempo of the TD-50, an "*" is shown before the tempo.

Controlling Tonal Change

You can use a pedal to change the pitch, or adjust the tone according to the position of your strike on the pad.

Reference

For details on the parameters that can be edited, refer to "Data List" (PDF).

1. In the DRUM KIT screen (p. 13), press the [F5] (MENU) button.
2. Press the PAGE [UP] [DOWN] button to access page 3 (KIT PAD CTRL).
3. Use the [F1] (PEDAL BEND)–[F4] (MUTE GRP) buttons to select the item that you want to edit.

| Button | Explanation |
|--------------------------|--|
| [F1] (PEDAL BEND) button | Specifies the amount of pitch change that occurs according to the depth to which you press the hi-hat pedal. |
| [F2] (POSITION) button*1 | Turns on/off tonal changes that occur depending on your strike location or the nuances of your rim shots. |
| [F3] (POS AREA) button*1 | Specifies the striking area for the head or rim. |
| [F4] (MUTE GRP) button | Mutes the sound of a specific pad when you strike the pad (mute group). |

*1 This supports the following trigger inputs.

- SNARE
- TOM1–4
- The bow (head) of RIDE
- AUX1–4

* Depending on the pad that is connected or the instrument that is selected, there might be cases in which this has no effect.

4. Select the pad that you want to edit (p. 20).
5. Use the [-] [+] buttons or the dial to edit the value.

Muting the sound of a specific pad when you strike a pad (mute group)

Mute group settings let you specify that when you strike a pad, other pads in the same mute group are muted (silenced).

For example, you could assign user samples to the instruments of each pad, and make mute group settings so that you can switch between user samples by striking different pads.

1. In the DRUM KIT screen (p. 13), press the [F5] (MENU) button.
2. Press the PAGE [UP] [DOWN] button to access page 3 (KIT PAD CTRL).
3. Press the [F4] (MUTE GRP) button.

The MUTE GROUP screen appears.

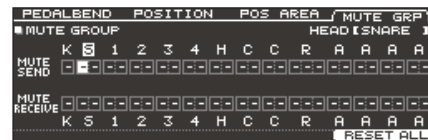

4. Select the pad that you want to edit (p. 20).
You can also use the cursor buttons to select a pad.
5. Use the cursor buttons, [-] [+] buttons, or the dial to make mute group settings.

| Parameter | Value | Explanation |
|--------------|-------------|--|
| MUTE SEND | | Specify the mute group number. When you strike the pad of the number specified in MUTE SEND, the sound of the pad assigned to the same number in MUTE RECEIVE is muted. |
| MUTE RECEIVE | -(OFF), 1–8 | * Even if you specify the same number in MUTE SEND and MUTE RECEIVE for the same location (e.g., head or rim) of the same pad, muting does not occur. |

When you specify a mute group, an arrow indicates the pads that are muted when you strike the currently selected pad, and the pads that when struck will mute the currently selected pad.

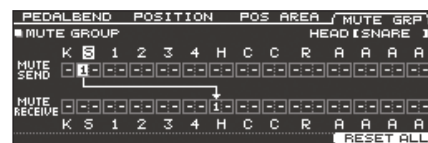

MEMO

To clear all mute groups, press the [F5] (RESET ALL) button.

Making MIDI Transmit/Receive Settings for Each Pad

You can specify how MIDI messages are transmitted and received for pad strikes.

Reference

For details on the parameters that can be edited, refer to “Data List” (PDF).

1. In the DRUM KIT screen (p. 13), press the [F5] (MENU) button.
2. Press the PAGE [DOWN] button to access page 4 (KIT PAD MIDI).
3. Use the [F1] (NOTE)–[F3] (MIDI CH) buttons to select the item that you want to edit.

| Button | Explanation |
|-----------------------|---|
| [F1] (NOTE) button | MIDI note number transmitted and received by each pad |
| [F2] (GATE) button | Duration of the note transmitted by each pad |
| [F3] (MIDI CH) button | MIDI channel used to transmit or receive note messages for each pad |

4. Select the pad that you want to edit (p. 20).
5. Use the [-] [+] buttons or the dial to edit the value.

MEMO

To return to the default values, press the [F5] (DEFAULT) button.

- * In order to play a pad from an external MIDI device, the MIDI note number and MIDI channel of the pad that you want to play must match the incoming note number and channel.

Importing and Playing Audio Files (USER SAMPLE)

Audio files that you created on your computer can be imported from an SD card into the TD-50, and played as instruments (user sample function). You can edit the sound of a user sample or apply effects to it in the same way as other instruments.

Audio files that can be loaded by the TD-50

| | WAV |
|----------------------|---------------------|
| Format (extension) | WAV (.wav) |
| Sampling frequency | 44.1 kHz |
| Bit rate | 16, 24-bit |
| Time (for each file) | Maximum 180 seconds |

- * File names or folder names that contain more than 16 characters are not shown correctly. Files and folders using double-byte characters are also not supported.

Importing an Audio File (IMPORT)

Here’s how to import an audio file into the TD-50 as a user sample.

1. Insert an SD card into the TD-50 (p. 8).
2. Hold down the [SHIFT] button and press the [SETUP] button.
3. Press the PAGE [UP] button to access page 1 (USER SAMPLE).
4. Press the [F1] (IMPORT) button.

The USER SAMPLE IMPORT screen appears.

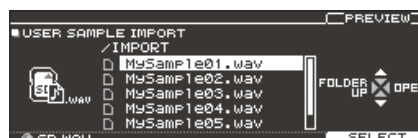

Selecting a file from the SD card

| Cursor button | Function |
|---------------|---------------------|
| [▲] button | Moves cursor (up) |
| [▼] button | Moves cursor (down) |
| [◀] button | Exits a folder |
| [▶] button | Enters a folder |

MEMO

- By pressing the [F4] (PREVIEW) button you can play back the selected audio file.
- It is convenient if the audio file to be imported has been saved in the IMPORT folder of the SD card.

5. Use the cursor buttons to select an audio file, and press the [F5] (SELECT) button.

The USER SAMPLE IMPORT (DESTINATION) screen appears.



6. Use the cursor buttons to select the import-destination number, and press the [F5] (IMPORT) button.

* If you select a number in which data already exists, the message "User Sample Exists!" appears. Select a number that contains no data.

MEMO

By pressing the [F3] (DELETE) button you can delete a previously-exported user sample.

7. Press the [F5] (IMPORT) button.

A confirmation message appears.

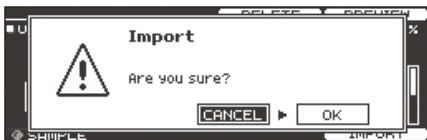

If you decide to cancel, select "CANCEL" and press the [ENTER] button.

8. Select "OK" and press the [ENTER] button.

The audio file is imported.

Listing the User Samples

Here's how to view a list of all user samples that have been imported.

You can audition the sound, specify looping, and edit the name.

1. Hold down the [SHIFT] button and press the [SETUP] button.

2. Press the PAGE [UP] button to access page 1 (USER SAMPLE).

3. Press the [F2] (SAMPLE LIST) button.

The USER SAMPLE screen appears.

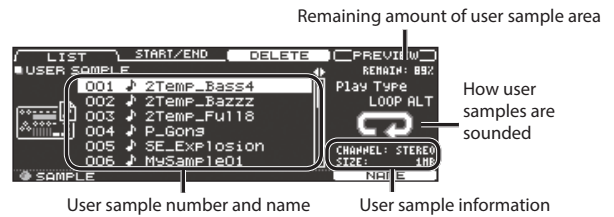

4. Turn the [R1] knob to select a user sample.

MEMO

You can press the [F4] (PREVIEW) button to play back the selected user sample. If you press the [F4] (PREVIEW) button once again during playback, the playback stops.

Assigning a User Sample to an Instrument and Playing It

1. Press the [INSTRUMENT] button.

2. Press the PAGE [UP] button to access page 1 (INSTRUMENT).

3. Press the [F1] (INST) button.



4. Select the pad that you want to edit (p. 20).

5. Move the cursor to the instrument group, and use the [-] [+] buttons or the dial to select "USER SAMPLE."



6. Turn the [R1] knob to select a user sample.

* Only the parameters of the INSTRUMENT screen (ADVANCED tab) can be edited for an instrument to which a user sample is assigned.

7. Press the [KIT] button to return to the DRUM KIT screen.

When you strike a pad to which the user sample is assigned, you hear that user sample.

MEMO

- You can assign a user sample to the instrument of each pad, and make mute group settings (p. 26) so that you can switch between user samples by striking the pads.
- You can also assign a user sample to a sub-instrument.

Specifying How the User Sample Is Sounded

You can specify how the user sample is sounded when you strike a pad, for example whether it sounds only once or repeatedly.

1. From the user sample list, select the user sample for which you want to make the setting.

2. Use the cursor [▶] button to move the cursor to Play Type, and use the [-] [+] buttons or the dial to change the value.

| Parameter | Value | Explanation |
|-----------|---------------|---|
| Play Type | ONE SHOT MONO | When you strike the pad, the currently-heard sound is silenced before the new sound is heard. Notes do not overlap. |
| | ONE SHOT POLY | When you strike the pad repeatedly, the sounds of the notes are heard overlapping. |
| | LOOP ALT | The user sample plays repeatedly (loop). Each time you strike the pad, the sound alternately plays or stops. |

MEMO

To stop a user sample that continues playing, you can use ALL SOUND OFF (p. 13) to stop the sound.

Specifying the Sounded Region of a User Sample

You can specify the region of a user sample that is actually sounded.

1. From the user sample list, select the user sample for which you want to make settings.
2. Press the [F2] (START/END) button.



3. Use the [R1]–[R3] knobs to edit the settings.

| Knob | Parameter | Explanation |
|------------|-----------|---|
| [R1] knob | Zoom | Zooms the waveform display in or out. You can zoom-in/out on the horizontal axis by turning the [R1] knob or by holding down the [SHIFT] button and pressing the cursor [◀] [▶] buttons. If you hold down the [SHIFT] button and turn the [R1] knob or use the cursor [▲] [▼] buttons, you'll zoom-in/out on the vertical axis. |
| [R2] knob | Start | Adjusts the start point (the location at which the user sample starts playing). |
| [R3] knobs | End | Adjusts the end point (the location at which the user sample stops playing). |

Deleting a User Sample

Here's how to delete a user sample.

1. From the user sample list, select the user sample that you want to delete.
2. Press the [F3] (DELETE) button.
A confirmation message appears.



If you decide to cancel, select "CANCEL" and press the [ENTER] button.

3. Select "OK" and press the [ENTER] button.
The user sample is deleted.

Renaming a User Sample

Here's how to rename a user sample.

1. From the user sample list, select the user sample that you want to rename.
2. Press the [F5] (NAME) button.
3. Edit the name (p. 25).
4. Press the [F5] (EXIT) button to exit the SAMPLE NAME screen.

Organizing User Samples

Here's how to renumber the user sample numbers or optimize the user sample area.

1. Hold down the [SHIFT] button and press the [SETUP] button.
2. Press the PAGE [DOWN] button to access page 2 (USER SAMPLE UTILITY).



3. Press one of the [F1] (RENUMBER)–[F3] (DELETE ALL) buttons to select a function.

A confirmation message appears.
Example) If you select RENUMBER



If you decide to cancel, select "CANCEL" and press the [ENTER] button.

| Button/Explanation |
|---|
| [F1] (RENUMBER) button Packing user sample numbers forward (RENUMBER) If you repeatedly import and delete user samples, the numbers will become discontinuous. This function lets you pack the user samples forward. The user sample assignments for drum kits are also updated so that they will sound correctly. If you execute RENUMBER, the user samples that are assigned to drum kits will no longer be correctly reproduced if you load previously-saved backup data (that does not include user samples). * If you executed RENUMBER, and then load previously-saved backup data or kit backup data (that does not include user samples), the user samples assigned to the drum kit will no longer be correctly reproduced. |
| [F2] (OPTIMIZE) button Optimizing the user sample area (OPTIMIZE) If you repeatedly import and delete user samples, the user sample area might become fragmented, reducing the number of user samples that can be loaded. This function optimizes the area so that user samples can be loaded. NOTE <ul style="list-style-type: none"> • Be sure to back up before executing this (p. 39). • This process might take more than an hour in some cases (This will vary depending on the number and size of the user samples). • Never turn off the power while this operation is in progress. If you do so, the user samples might be lost. • In some cases, optimizing might not produce results. |
| [F3] (DELETE ALL) button Deleting all user samples (DELETE ALL) All user samples in the user memory are deleted. NOTE All user samples used in drum kits are also deleted. Pads to which a user sample is assigned will no longer produce sound. |

4. Select "OK" and press the [ENTER] button.
The selected function is executed.

Utility Functions

Using the TD-50 with a Computer

You can connect the TD-50 to your computer, and record MIDI and ten channels of multi-track audio into a DAW. Audio played back by your computer can also be heard via the TD-50.

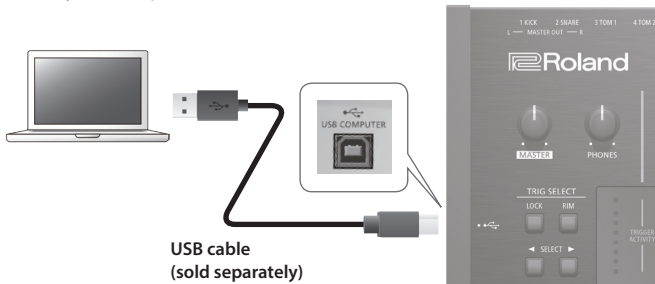

NOTE

- For some types of computer, this might not work correctly. Refer to the Roland website for details on the operating systems that are supported.
- A USB cable is not included. You can purchase one from the dealer where you purchased the TD-50.
- Use a USB 2.0 cable.
- Your computer's USB port must support USB 2.0 Hi-Speed.

USB Driver Installation and Settings

Installing the USB driver

The USB driver is software that transfers data between the TD-50 and the software on your computer.

In order to transmit or receive audio via USB, the USB driver must be installed.

MEMO

- Before you install the USB driver, change the TD-50's USB driver setting to **"VENDOR"**.
- For details on downloading and installing the USB driver, refer to the Roland website.

<http://www.roland.com/support/>

Changing the USB driver setting

Here's how to switch between the TD-50's dedicated USB driver and the driver provided by your operating system.

1. In the **SETUP MENU 1** screen (p. 42), press the **[F2] (USB AUDIO)** button.

The **USB AUDIO SETUP** screen appears.

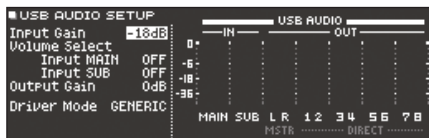

2. Move the cursor to **Driver Mode**, and use the **[-] [+]** buttons or the dial to change the value.

| Parameter | Value | Explanation |
|-------------|---------|--|
| Driver Mode | GENERIC | Use the driver provided by the operating system. Operation is limited to USB MIDI. |
| | VENDOR | Use the TD-50's dedicated driver provided by Roland. USB MIDI and USB audio can be used. |

MEMO

The setting takes effect when the TD-50 is powered off and on again.

3. Turn the power off, and then on again

Specifying the Output for USB Audio

You can specify the output destination of the USB audio that is sent from the **USB COMPUTER** port.

Ten channels from the USB audio output can be multi-track recorded into a DAW on your computer.

- * The **LO CUT** and **ATT (OUTPUT ROUTING)** (p. 43)) effects do not apply to the USB audio output. For details on the parameters, refer to "Data List" (PDF).

MEMO

For details on settings in your DAW, refer to the owner's manual of the DAW you're using.

Specifying the output destination for USB audio

The output destination setting for USB audio is shared with the output destination setting of the **MASTER OUT** jacks and the **DIRECT OUT** jacks.

You can select a total of 10 channels of output destination from **MASTER OUT L, R**, and **DIRECT OUT 1-8**.

Reference

For more about output destination settings, refer to "Audio Output Assignments (OUTPUT)" (p. 42).

Adjusting the USB audio output level

1. In the **SETUP MENU 1** screen (p. 42), press the **[F2] (USB AUDIO)** button.

The **USB AUDIO SETUP** screen appears.

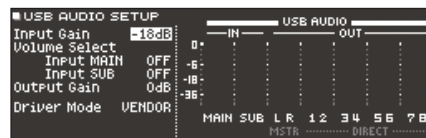

2. Move the cursor to **Output Gain**, and use the **[-] [+]** buttons or the dial to change the value.

| Parameter | Value | Explanation |
|-------------|------------|--|
| Output Gain | -24 +24 dB | Adjusts the output level. This applies to all USB audio output that is sent from the USB COMPUTER port. |

Specifying the Input for USB Audio

Here's how to specify the USB audio input that is input to the USB COMPUTER port.

This allows audio that is played back by the computer to be heard from the TD-50.

1. In the SETUP MENU 1 screen (p. 42), press the [F2] (USB AUDIO) button.

The USB AUDIO SETUP screen appears.

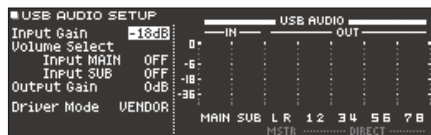

2. Use cursor buttons to select a parameter, and use the [-] [+] buttons or the dial to edit the value.

| Parameter | Value | Explanation |
|----------------------------------|------------|--|
| Input Gain | -36~+12 dB | Adjusts the input level This applies to the USB audio inputs (Input MAIN, SUB) that are input from the USB COMPUTER port. |
| Volume Select Input MAIN, SUB | OFF | Specifies the knob that adjusts the input volume of USB audio (Input MAIN, SUB). The volume is not adjusted by a knob. |
| | SONG | The [SONG] knob adjusts the volume. |
| | CLICK | The [CLICK] knob adjusts the volume. |

MEMO

You can specify the output destination of the sound that is input via USB audio (p. 42).

Copying Settings (COPY)

The TD-50 lets you copy various settings within the unit or to an SD card.

You can also exchange settings between a copy-source and copy-destination.

NOTE

When you execute a copy operation, the contents of the copy-destination are overwritten. If the destination contains settings that you want to keep, back them up to an SD card (p. 39).

1. Hold down the [SHIFT] button and press the [SD CARD] button.

The COPY MENU screen appears.



2. Use the PAGE [UP] [DOWN] buttons and the function buttons to select an item in the copy menu.

| Copy menu | Explanation |
|--------------------|--|
| COPY MENU 1 | |
| KIT | Copy a drum kit (p. 13). |
| PAD INST | Copy a pad's instrument (p. 19). |
| INST SET | Copy multiple instruments as a set. |
| SET LIST | Copy a set list (p. 33). |
| COPY MENU 2 | |
| VOLUME | Copy the MIXER VOLUME (p. 22) settings. |
| PAN | Copy the MIXER PAN (p. 22) settings. |
| AMBIENCE | Copy the ambience (p. 22) settings. |
| MFX | Copy the multi-effect (p. 23) settings. |
| COPY MENU 3 | |
| TRIGGER | Copy the trigger (p. 35) settings. |
| REC DATA | Copy recorded data (p. 17) to an SD card. * The copy-source and copy-destination cannot be exchanged. |

3. Copy the settings according to the menu item that you selected.

Example 1) Copying a drum kit (KIT)

1. In the COPY MENU 1 screen, press the [F1] (KIT) button.

The COPY KIT screen appears.

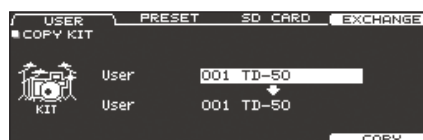

2. Press one of the [F1] (USER)–[F3] (SD CARD) buttons to select a function.

| Button | Explanation |
|-----------------------|---|
| [F1] (USER) button | Copies from user memory. Only if the copy-source is user, you can exchange the copy-source and copy-destination. |
| [F2] (PRESET) button | Copies kits of preset memory. Choose this if you want to return to the factory-set kit settings. * User samples that are assigned to a factory-set kit cannot be copied. |
| [F3] (SD CARD) button | Copies kits from backup data saved on an SD card. |

- Use cursor buttons to select the parameters, and use the [-] [+] buttons or the dial to specify the copy settings.

USER, PRESET

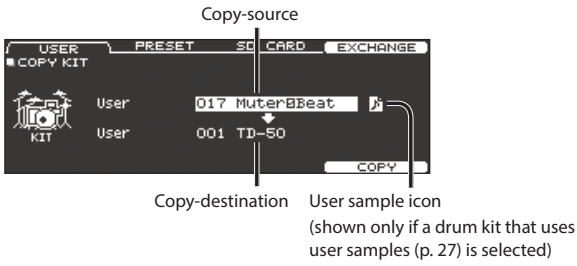

SD CARD

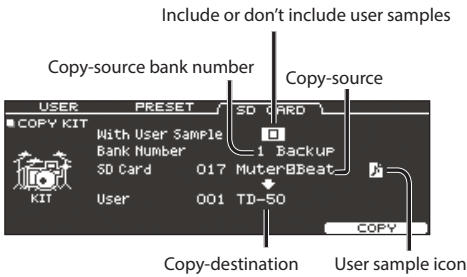

* If you are copying backup data that does not include user samples, you can't select the "With User Sample" check box.

- Press the [F5] (COPY) button.

By pressing the [F4] (EXCHANGE) button you can exchange user memories (USER only).

A confirmation message appears.



If you decide to cancel, select "CANCEL" and press the [ENTER] button.

- Select "OK" and press the [ENTER] button.

The drum kit is copied.

Example 2) Copying multiple instruments as a set (INST SET)

- In the COPY MENU 1 screen (p. 31), press the [F3] (INST SET) button.

The COPY PAD INST SET screen appears.

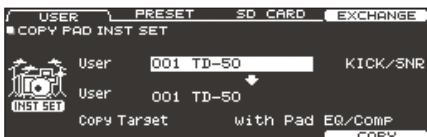

- Press one of the [F1] (USER)–[F3] (SD CARD) buttons to select a function.

| Button | Explanation |
|-----------------------|--|
| [F1] (USER) button | Copies from user memory. Only if the copy-source is user, you can exchange the copy-source and copy-destination. |
| [F2] (PRESET) button | Copies instruments of preset memory. Choose this if you want to return to the factory-set kit settings. * User samples that are assigned to a factory-set kit cannot be copied. |
| [F3] (SD CARD) button | Copies instruments from backup data saved on an SD card. |

- Use cursor buttons to select the parameters, and use the [-] [+] buttons or the dial to specify the copy settings.

USER, PRESET

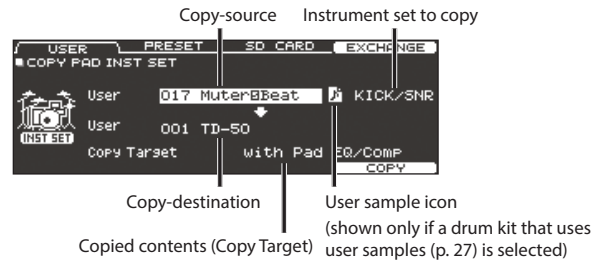

SD CARD

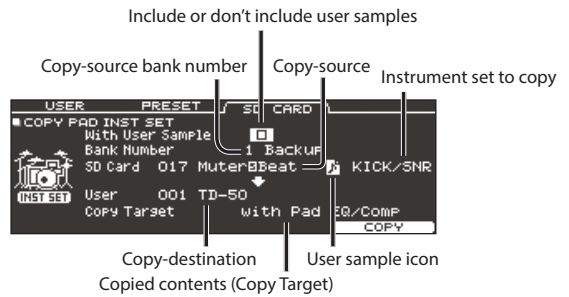

* If you are copying backup data that does not include user samples, you can't select the "With User Sample" check box.

Instrument set to copy

| Value | Explanation |
|----------|------------------------------------|
| KICK/SNR | Copy KICK and SNARE. |
| TOMS 1-4 | Copy TOM 1-4. |
| CYM SET | Copy HI-HAT, CRASH 1, 2, and RIDE. |
| AUX 1-4 | Copy AUX 1-4. |

Copied contents (Copy Target)

| Value | Explanation |
|------------------|--|
| with Pad EQ/Comp | Copies the pad's instrument settings (e.g., instrument, V-EDIT) and the pad equalizer and pad compressor settings (p. 23). |
| Inst/VEdit Only | Copies only the pad's instrument settings (e.g., instrument, V-EDIT). |
| Pad EQ/Comp Only | Copies only the pad equalizer and pad compressor settings (p. 23). |

4. Press the [F5] (COPY) button.

By pressing the [F4] (EXCHANGE) button you can exchange user memories (USER only).

A confirmation message appears.



If you decide to cancel, select "CANCEL" and press the [ENTER] button.

5. Select "OK" and press the [ENTER] button.

The instrument is copied.

Recalling Drum Kits Successively (SET LIST)

You can specify an order in which drum kits are recalled in 32 steps (step 1 through step 32). Such an order is called a "set list," and you can create 32 set lists.

You can create a set list for the order in which you use drum kits in a live performance, and then instantly recall the drum kit that you'll use next.

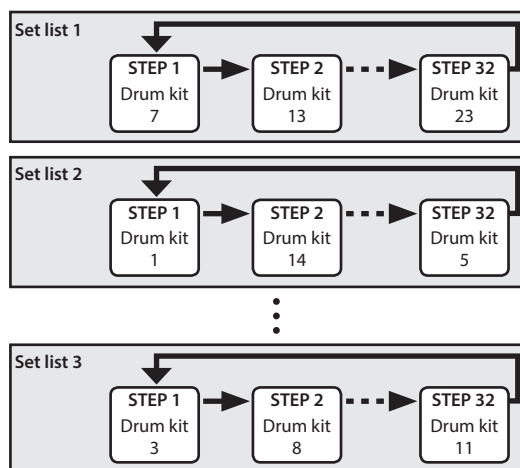

Creating a Set List

1. Press the [SET LIST] button to make it light.

The SET LIST screen appears, and set list turns on.



| Button | Explanation |
|--------------------------|-------------------------------------|
| [F1] (◀ SET LIST) button | |
| [F2] (SET LIST ▶) button | Select a set list. |
| [F5] (SETUP) button | Create, edit, or rename a set list. |

Exchanging or renaming set lists

2. Press the [F5] (SETUP) button.

The setup screen appears.

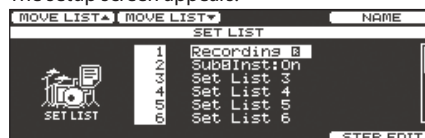

| Button | Explanation |
|---------------------------|---|
| [F1] (MOVE LIST ▲) button | Changes the order of the set list at the cursor position. |
| [F2] (MOVE LIST ▼) button | Changes the order of the set list at the cursor position. |
| [F4] (NAME) button | Renames the set list at the cursor position (p. 25). |
| [F5] (STEP EDIT) button | Edits the steps of the set list at the cursor position. |

Editing the steps of a set list

3. Press the [F5] (STEP EDIT) button.

The SETLIST STEP EDIT screen appears.

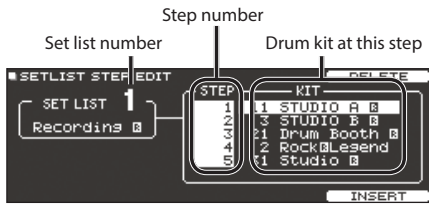

4. Use the cursor buttons to select each step, and use the [-] [+] buttons or the dial to specify the drum kit at that step.

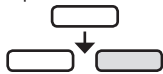
| Button | Explanation |
|----------------------|--|
| [F4] (DELETE) button | Step at the cursor position is deleted, and steps after this point are moved forward one place.  |
| [F5] (INSERT) button | The same kit is inserted at the cursor position, and steps after this point are moved backward one place.  |

MEMO

If the set list is empty, move the cursor to "END" and use the [-] [+] buttons or the dial to specify a drum kit.

5. Press the [KIT] button to return to the SET LIST screen.

Using Set Lists

Selecting a set list

1. Press the [SET LIST] button to make it light.

The set list function turns on.



2. Press the [F1] (◀ SET LIST) button or [F2] (SET LIST ▶) button to select the set list that you want to use.

Switching drum kits

1. Use the [-] [+] buttons or the dial to select drum kits in the order of the specified steps.

2. When you've finished playing, press the [KIT] button or the [EXIT] button to make the [SET LIST] button go dark.

The set list function turns off.

MEMO

- You can assign the appropriate function to a footswitch or pad, and use it to recall set lists or drum kits. For details, refer to "Assigning Functions to Foot Switches or Pads (CONTROL)" (p. 44).
- If there are discrepancies between the volumes of each kit, press the [MIXER] button and adjust the Kit Volume (overall volume of the entire kit) (p. 22).

Settings

Trigger Settings (TRIGGER)

Here's how to make trigger settings so that the signals from the pads can be accurately processed by the TD-50.

Specifying the Pad Type

You can specify the type of pad (trigger type) used by each trigger input of the trigger bank.

Trigger type

The trigger type is a collection of various trigger parameters, adjusted to values that are appropriate for each pad. To obtain the optimal settings for the pad used with each trigger input, specify the model (type) of pad that's connected.

Trigger bank

A trigger bank contains an entire set of settings for 14 triggers. You can create eight trigger banks.

Reference

For details on the parameters that can be edited, refer to "Data List" (PDF).

1. Press the [TRIGGER] button.
 2. Press the PAGE [UP] button to access page 1 (TRIG BASIC).
 3. Press the [F1] (BANK) button.
- The TRIGGER BANK screen appears.

Trigger bank number

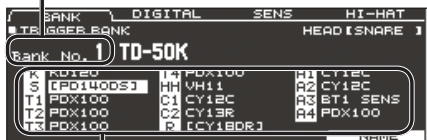

Trigger type

4. Move the cursor to the trigger bank number, and use the [-] [+] buttons or the dial to select a bank.
5. Select the pad whose settings you want to edit (p. 20).

You can also use the cursor buttons to make a selection.

| Pad | Explanation |
|-------|-------------|
| K | KICK |
| S | SNARE |
| T1-4 | TOM1-4 |
| HH | HI-HAT |
| C1, 2 | CRASH1, 2 |
| R | RIDE |
| A1-4 | AUX1-4 |

6. Use the [-] [+] buttons or the dial to specify the trigger type.

* You can't change the trigger type of a trigger input that's assigned to a pad that supports a digital connection.

MEMO

When you specify the trigger type, the trigger parameters (with the exception of certain parameters such as cross-stick cancel)* are set to optimal values. These values are only general guidelines; you can make fine adjustments as appropriate according to how you attach the pad and how you use it.

* For details, refer to "Data List" (PDF).

Specifying a Digitally-Connected Pad

The first time that you connect a pad that supports digital connection to a DIGITAL TRIGGER IN port, you'll follow the screens that appear, and specify the trigger input to which the connected pad is assigned (p. 9).

Here you'll make settings to change the assignment destination.

- * If you specify the same trigger input as a pad that is connected to a TRIGGER IN jack, the pad that's connected to that TRIGGER IN jack won't produce sound.
- * When you execute a factory reset, the connection history and settings of digitally-connected pads are initialized.

1. Press the [TRIGGER] button.
2. Press the PAGE [UP] button to access page 1 (TRIG BASIC).
3. Press the [F2] (DIGITAL) button.

The DIGITAL TRIGGER IN screen appears.

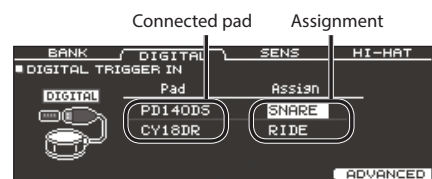

4. Use the cursor buttons to select the pad that you want to specify, and use the [-] [+] buttons or the dial to specify the assignment.

You can also select a pad by striking it.

If you don't want to assign the pad to any trigger input, choose "N/A."

- * You can't specify multiple instances of the same assignment.

Adjusting the Pad Sensitivity

Because the following settings are automatically set to the appropriate values for each pad when you specify the trigger type (p. 35), there is normally no need for you to edit them.

You can edit these settings if you want to make finer adjustments, or if you want to use an acoustic drum trigger.

1. Press the [TRIGGER] button.
2. Press the PAGE [UP] button to access page 1 (TRIG BASIC).
3. Press the [F3] (SENS) button.

The TRIGGER SENS screen appears.

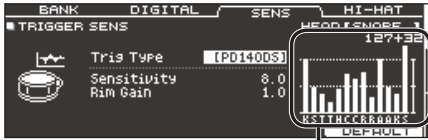

Velocity meter (Indicates the force (velocity) of the strike.)

| Display | Explanation | Display | Explanation |
|---------|-------------|---------|-------------|
| K | KICK | C | CRASH1, 2 |
| S | SNARE | R | RIDE |
| T | TOM1-4 | A | AUX1-4 |
| H | HI-HAT | | |

4. Select the pad that you want to edit (p. 20).
5. Use cursor buttons to select a parameter, and use the [-] [+] buttons or the dial to edit the value.

| Parameter | Value | Explanation |
|-------------|----------|--|
| Sensitivity | 1.0-32.0 | You can adjust the sensitivity of the pads to accommodate your personal playing style. Increasing this value increases the sensitivity, so that even soft strikes on the pad are sounded at high volume. Decreasing this value decreases the sensitivity, so that even strong strikes on the pad are sounded at low volume. |
| Rim Gain | 0-3.2 | Adjusts the balance between the force of striking the rim or edge and the loudness of the sound. If you increase this value, even soft strikes on the rim are sounded at high volume. If you decrease this value, even strong strikes on the rim are sounded at low volume. This is available for pads that support rim shots. |

MEMO

- To return to the default values, press the [F5] (DEFAULT) button. Trigger parameters (with the exception of certain parameters such as cross-stick cancel)* are set to the default value.
* For details, refer to "Data List" (PDF).
- Velocity is shown as a maximum of 127 for pads that are connected to a TRIGGER IN jack, and as a maximum of 127+32 for pads that support digital connection and are connected to a DIGITAL TRIGGER IN port.

Adjusting the Hi-Hat Settings

If you are using a V hi-hat, adjust the offset on the TD-50.

This is necessary in order to correctly detect open/close operations and pedal movement.

Reference

- For details on how to adjust the offset, refer to "Making Hi-hat Settings" (p. 11).
- Make detailed adjustments to the parameters as necessary. For details, refer to "Data List" (PDF).

Making Detailed Adjustments for the Trigger

Because the following settings are automatically set to the appropriate values for each pad when you specify the trigger type (p. 35), there is normally no need for you to edit them.

Edit these settings only if you want to make detailed adjustments to the pad's sensitivity, signal detection, and strike location detection.

Reference

For details on the parameters that can be edited, refer to "Data List" (PDF).

1. Press the [TRIGGER] button.
2. Press the PAGE [UP] [DOWN] button to access page 2 (TRIG ADVANCED).

The trigger advanced screen appears.

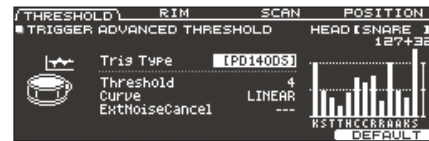

3. Press a [F1] (THRESHOLD)–[F4] (POSITION) button to select the item that you want to edit.

| Button | Explanation |
|-------------------------|--|
| [F1] (THRESHOLD) button | Edits detailed settings for pad sensitivity. |
| [F2] (RIM) button | Edits detailed settings for rim shots. |
| [F3] (SCAN) button | Edits detailed settings for trigger signal detection. |
| [F4] (POSITION) button | Edits detailed settings for strike location detection. |

4. Select the pad that you want to edit (p. 20).
5. Use cursor buttons to select a parameter, and use the [-] [+] buttons or the dial to edit the value.

MEMO

To return to the default values, press the [F5] (DEFAULT) button. Trigger parameters (with the exception of certain parameters such as cross-stick cancel)* are set to the default value.
* For details, refer to "Data List" (PDF).

Making Detailed Settings for Digitally-Connected Pads

The first time that you connect a pad that supports digital connection, the following settings are automatically set to values that are optimal for each pad, so it is normally not necessary to specify them.

Edit these settings if you want to make more detailed adjustments.

Reference

For details on the parameters that can be edited, refer to "Data List" (PDF).

1. In the DIGITAL TRIGGER IN screen (p. 35), press the [F5] (ADVANCED) button.

The DIGITAL TRIGGER ADVANCED screen appears.

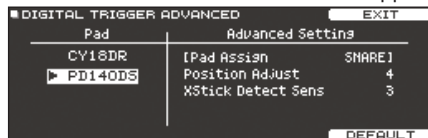

2. To select the pad that you want to specify, use the cursor buttons or strike a pad.
3. Press the cursor [▶] button to move the cursor to the Advanced Setting parameters.
4. Use cursor buttons to select a parameter, and use the [-] [+] buttons or the dial to edit the value.

* The parameters that you can edit will differ depending on the pad.

MEMO

To return to the default values, press the [F5] (DEFAULT) button. Trigger parameters (with the exception of certain parameters such as cross-stick cancel)* are set to the default value.

* For details, refer to "Data List" (PDF).

Viewing Trigger Information for Each Pad

You can view realtime information that shows the force (velocity) with which each pad is struck, how far the hi-hat is open, and the strike position on the snare, ride cymbal, toms, and AUX.

MEMO

Performance data received from the MIDI IN connector is also shown.

1. Press the [TRIGGER] button.
2. Press the PAGE [DOWN] button to access page 3 (TRIG MONITOR).
3. Press the [F1] (TRIG) button.

The TRIGGER MONITOR screen appears.



Velocity meter
(Indicates the force (velocity) of the strike.)

| Display | Explanation | Display | Explanation |
|---------|-------------|---------|-------------|
| K | KICK | C | CRASH1, 2 |
| S | SNARE | R | RIDE |
| 1-4 | TOM1-4 | A | AUX1-4 |
| H | HI-HAT | | |

4. Strike the pads.

The meter indications in the screen will move in realtime, allowing you to view the following information.

| Display | Explanation |
|----------|--|
| HI-HAT | Shows how far the hi-hat is open. The indicator will move toward "OPEN" as the hi-hat opens, and toward "PRESS" as it closes. |
| POSITION | Indicates the rim strike position on the snare, ride cymbal, toms, and AUX. The indicator will move toward "CENTER" as the strike is closer to the center of the pad, and toward "OUTER" as the strike is closer to the edge of the pad. |
| INTERVAL | Indicates the time interval at which the pad is struck. The farther toward the right, the shorter the interval. The tonal character of a cymbal or snare roll changes smoothly. |
| CHOKE | The "CHOKE" icon appears when the cymbal is choked. The CHOKE icon appears when you use the choke technique on a pad that supports choking. |

Eliminate Crosstalk Between Pads (Crosstalk Cancellation)

If two pads are attached to the same stand, the vibration from one struck pad may cause the other pad to sound without your intention. This is called “crosstalk.” Crosstalk cancellation is a setting that prevents this type of crosstalk.

- * When the TD-50 is shipped from the factory, it is set for optimal operation with the separately sold drum stand (MDS-50KV or MDS-50K), so you will not normally need to change the settings. You’ll need to make crosstalk cancellation settings in the following cases.
 - When using a pad configuration not found in the trigger bank settings (p. 35)
 - When using a drum stand other than the separately sold drum stand (MDS-50KV or MDS-50K)
 - When using a drum trigger (sold separately)
- * In some cases, the acoustic sound from an acoustic drum or from a monitor speaker might cause a pad to be triggered. In such cases, adjusting the crosstalk cancelation settings will not solve the problem. Pay attention to the following considerations when setting up your equipment.
 - Set up the pads at a distance from the speakers
 - Angle the pads, placing them where they are less likely to be affected by the sound
 - Increase the Threshold value of the pad (refer to “Data List” (PDF))

Tips for positioning the pads

You can prevent crosstalk by positioning the pads in a way that minimizes their susceptibility to an external source of vibration. Before you adjust the crosstalk cancellation settings, please note the following points when setting up your system.

- Don’t place pads in contact with each other.
- If attaching multiple pads to the same stand, increase the distance between them.
- Firmly tighten the knobs that fasten the pad to ensure that the pad is securely attached to the stand.

Example) Crash 1 is triggered when you strike the Tom 1 pad

1. Press the [TRIGGER] button.
2. Press the PAGE [DOWN] button to access page 3 (TRIG MONITOR).
3. Press the [F2] (XTALK) button.

The TRIGGER XTALK MONITOR screen appears.

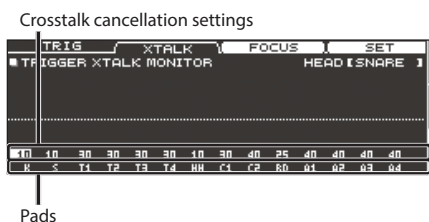

4. Strike the tom 1 (T1) pad

The crosstalk detection status is shown in the TRIGGER XTALK MONITOR screen.

The illustration below indicates that tom 2 (T2) and crash 1 (C1) detected vibration when tom 1 (T1) was struck.

A “▲” symbol is shown for pads that are experiencing crosstalk.

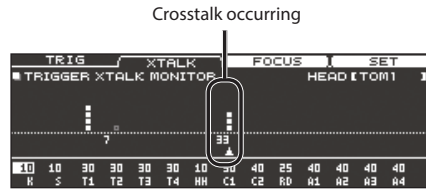

| Pads detecting vibration | Explanation |
|--------------------------|--|
| Tom 2 (T2) | Will not sound, because crosstalk cancellation is active. |
| Crash 1 (C1) | Crosstalk is occurring. By adjusting the crosstalk cancellation value, you can prevent the sound from being triggered. |

5. Press the [F3] (FOCUS) button to move the cursor to C1.



If crosstalk is occurring for multiple pads, each press of the [F3] (FOCUS) button will move the cursor to another pad that is experiencing crosstalk.

6. Press the [F4] (SET) button.

In this case, the value is automatically set to “33,” which is the minimum value that can cancel triggering for crash 1.

| Value | Explanation |
|-------|------------------------------------|
| 0–80 | Strength of crosstalk cancellation |

- * The value will not exceed 40 when you set crosstalk cancellation automatically. If you need to set this value above 40, use the [-] [+] buttons or the dial to edit the value.

7. Repeat steps 5 and 6 to make crosstalk cancellation settings.

MEMO

You can also use the cursor [◀] [▶] buttons, [-] [+] buttons, or the dial to make crosstalk cancellation settings manually.

Backing Up Data to an SD Card (SD CARD)

Settings stored in the TD-50 can be saved (backed up) to an SD card, or loaded into the TD-50.

Backing Up All Settings (SAVE)

Here's how all settings stored in the TD-50 can be backed up as a single set to an SD card (up to 99 sets).

1. Insert an SD card into the TD-50 (p. 8).
2. Press the [SD CARD] button.
3. Press the PAGE [UP] button to access page 1 (SD CARD BACKUP ALL).
4. Press the [F1] (SAVE) button.

The SD CARD SAVE <BACKUP ALL> screen appears.

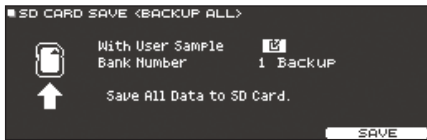

5. Make backup settings.

| Parameter | Explanation |
|------------------|---|
| With User Sample | Select whether previously-imported user samples are also backed up. |
| Bank Number | Select the backup number. |

- * If you back up user samples as well, it may take several minutes to save the data depending on the size of the user samples. If you don't back up user samples, and you then delete user samples or renumber them, the kit won't be reproduced correctly even if you load the backup.

6. Press the [F5] (SAVE) button.

MEMO

If you want to assign a name to the backup data, press the [F4] (NAME) button and assign a name (p. 25).

7. Press the [F5] (EXECUTE) button.

A confirmation message appears.



If you decide to cancel, select "CANCEL" and press the [ENTER] button.

8. Select "OK" and press the [ENTER] button.

The backup data is saved on the SD card.

Loading Backup Data from an SD Card (LOAD)

Here's how backup data that was saved on an SD card can be loaded into the TD-50.

1. Insert an SD card into the TD-50 (p. 8).
2. Press the [SD CARD] button.
3. Press the PAGE [UP] button to access page 1 (SD CARD BACKUP ALL).
4. Press the [F2] (LOAD) button.

The SD CARD LOAD <BACKUP ALL> screen appears.

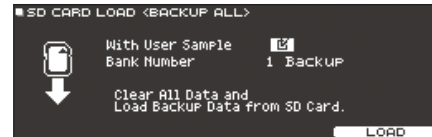

5. Make load settings.

| Parameter | Explanation |
|------------------|--|
| With User Sample | Select whether user samples are also loaded. |
| Bank Number | Select the backup number. |

- * When you load user samples, the user samples included in the backup data are overwritten onto the user samples in user memory. Depending on the size of the user samples, it might take ten minutes or more to load the data.
- * If you are loading backup data that does not include user samples, you can't select the "With User Sample" check box.

6. Press the [F5] (LOAD) button.

A confirmation message appears.



If you decide to cancel, select "CANCEL" and press the [ENTER] button.

7. Select "OK" and press the [ENTER] button.

The backup data is loaded from the SD card.

Backing Up Drum Kit to an SD Card (1 KIT SAVE)

Here's how settings of an individual drum kit stored in the TD-50 can be backed up to an SD card (up to 999 drum kits).

1. Insert an SD card into the TD-50 (p. 8).
2. Press the [SD CARD] button.
3. Press the PAGE [UP] [DOWN] button to access page 2 (SD CARD BACKUP 1KIT).
4. Press the [F1] (1KIT SAVE) button.

The SD CARD SAVE <1KIT> screen appears.

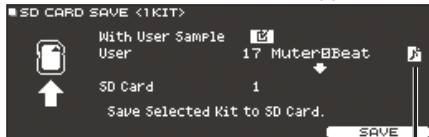

User sample icon (shown only if a drum kit that uses user samples (p. 27) is selected)

5. Make backup settings.

| Parameter | Explanation |
|------------------|--|
| With User Sample | Select whether the user samples assigned to the drum kit are also backed up. |
| User | Select the drum kit that you want to back up. |
| SD Card | Select the backup number. |

* If you back up user samples as well, it may take several minutes to save the data depending on the size of the user samples. If you do not back up user samples, loading the kit backup data will not correctly reproduce the drum kit if you have deleted user samples from the TD-50 after making the backup or if you have renumbered them.

6. Press the [F5] (SAVE) button.

A confirmation message appears.



If you decide to cancel, select "CANCEL" and press the [ENTER] button.

7. Select "OK" and press the [ENTER] button.

The kit backup data is saved on the SD card.

Loading Kit Backup Data from an SD Card (1 KIT LOAD)

Here's how kit backup data that was saved on an SD card can be loaded into the TD-50.

1. Insert an SD card into the TD-50 (p. 8).
2. Press the [SD CARD] button.
3. Press the PAGE [UP] [DOWN] button to access page 2 (SD CARD BACKUP 1KIT).

4. Press the [F2] (1KIT LOAD) button.

The SD CARD LOAD <1KIT> screen appears.



User sample icon (shown only if a drum kit that uses user samples (p. 27) is selected)

5. Make load settings.

| Parameter | Explanation |
|------------------|--|
| With User Sample | Select whether the user samples saved together with the drum kit are loaded. |
| SD Card | Select the backup number. |
| User | Select the load-destination drum kit. |

- * When you load user samples, new user samples are created even if the same user samples already exist. The newly created user samples are automatically assigned to the loaded drum kit.
- * In order to load user samples, there must be sufficient free space for the user samples.
- * If you are loading the kit backup data that does not include user samples, you can't select the "With User Sample" check box.

6. Press the [F5] (LOAD) button.

A confirmation message appears.



If you decide to cancel, select "CANCEL" and press the [ENTER] button.

7. Select "OK" and press the [ENTER] button.

The kit backup data is loaded from the SD card.

SD card folder structure

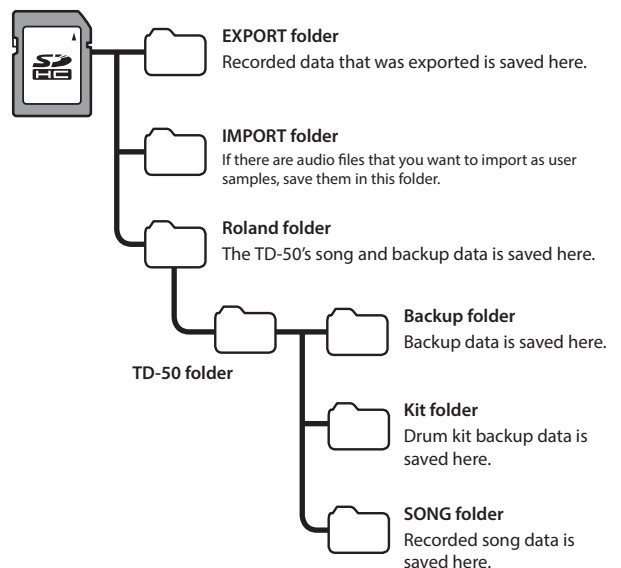

Deleting Backup Data from an SD Card (DELETE/1 KIT DELETE)

Here's how to delete unneeded backup data (including user samples) from an SD card.

1. Insert an SD card into the TD-50 (p. 8).
2. Press the [SD CARD] button.
3. Use the PAGE [UP] [DOWN] buttons and the function buttons to select a backup menu item.

| Backup menu | Explanation |
|---|--------------------------|
| DELETE (page 1 (SD CARD BACKUP ALL)) | Deletes backup data. |
| 1 KIT DELETE (page 2 (SD CARD BACKUP 1KIT)) | Deletes kit backup data. |

The SD CARD DELETE screen appears.

Example) When using DELETE

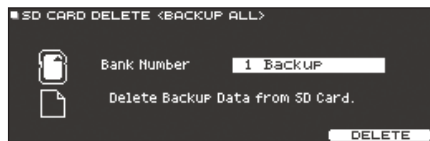

4. Specify the deletion settings.

| Parameter | Explanation |
|-----------------------------------|---|
| Bank Number (when using DELETE) | Select the backup number that you want to delete. |
| SD Card (when using 1 KIT DELETE) | Select the kit backup number that you want to delete. |

5. Press the [F5] (DELETE) button.

A confirmation message appears.

Example) When using DELETE



If you decide to cancel, select "CANCEL" and press the [ENTER] button.

6. Select "OK" and press the [ENTER] button.

The backup data is deleted from the SD card.

Checking the Usage Status of an SD Card (INFO)

Here's how to check the number of settings that are saved on the SD card.

1. Insert an SD card into the TD-50 (p. 8).
2. Press the [SD CARD] button.
3. Press the PAGE [DOWN] button to access page 3 (SD CARD UTILITY).
4. Press the [F1] (INFO) button.

The SD CARD INFO screen appears.

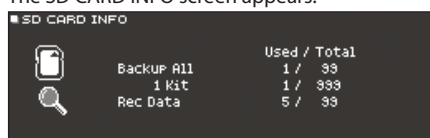

| Parameter | Explanation |
|------------|---------------------------------|
| Backup All | Number of saved backup data |
| 1 Kit | Number of saved kit backup data |
| Rec Data | Number of saved recorded data |

5. Press the [KIT] button to return to the DRUM KIT screen.

Formatting an SD Card (FORMAT)

Here's how to format an SD card.

- * Before using an SD card for the first time with the TD-50, you must format the SD card.

NOTE

When you format an SD card, all data on the SD card is erased. If important data is saved on the SD card, back up the data to your computer before you proceed with formatting the SD card.

1. Insert an SD card into the TD-50 (p. 8).
2. Press the [SD CARD] button.
3. Press the PAGE [DOWN] button to access page 3 (SD CARD UTILITY).
4. Press the [F3] (FORMAT) button.

The SD CARD FORMAT screen appears.

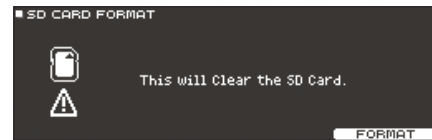

5. Press the [F5] (FORMAT) button.

A confirmation message appears.



If you decide to cancel, select "CANCEL" and press the [ENTER] button.

6. Select "OK" and press the [ENTER] button.

The SD card will be formatted.

NOTE

While formatting is in progress, never turn off the power or remove the SD card.

Settings for the Entire TD-50 (SETUP)

Settings that are common to the entire TD-50, such as the output destination settings and the footswitch settings, are called “setup” data.

1. Press the [SETUP] button.

The SETUP MENU screen appears.



2. Use the PAGE [UP] [DOWN] buttons and the function buttons to select the setup menu that you want to edit.

| Setup menu | Explanation | Page |
|---------------------|---|-------|
| SETUP MENU 1 | | |
| OUTPUT | Specifies the output destination of the sounds. | p. 42 |
| USB AUDIO | Makes USB audio settings. | p. 30 |
| OPTION | Makes settings for the [PREVIEW] button, the MIX IN jacks, and the display. | p. 44 |
| CONTROL | Assigns functions to the footswitch and pads. | p. 44 |
| SETUP MENU 2 | | |
| MIDI | Makes MIDI settings. | p. 45 |
| AUTO OFF | Makes AUTO OFF settings. | p. 10 |
| INFO | Displays information about the TD-50 itself, such as the program version. | p. 46 |
| SETUP MENU 3 | | |
| FACTORY RESET | Returns the TD-50 to its factory settings. | p. 46 |

3. Edit the settings of the menu that you selected.

Audio Output Assignments (OUTPUT)

Here’s how to assign the audio outputs from the MASTER OUT jacks, DIRECT OUT jacks, and PHONES jacks.

MEMO

The output destination setting for USB audio (p. 30) is shared with the output destination setting of the MASTER OUT jacks and the DIRECT OUT jacks.

1. In the SETUP MENU 1 screen, press the [F1] (OUTPUT) button.

2. Use the PAGE [UP] [DOWN] buttons and the function buttons to select the audio output that you want to assign.

1 page (PAD OUTPUT)

[F1] (MASTER) button

Specify each pad’s output assignments for the PHONES jacks and MASTER OUT jacks (when OUTPUT ROUTING Master Out is set to “NORMAL”).

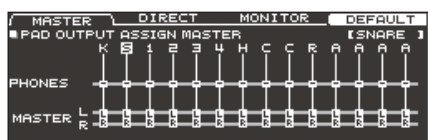

[F2] (DIRECT) button

Specify each pad’s output assignments for the PHONES jacks and MASTER OUT jacks (when OUTPUT ROUTING Master Out is set to “DIRECT”).

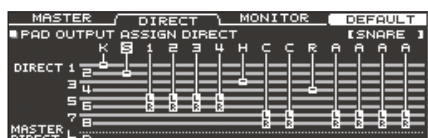

[F3] (MONITOR) button

Monitor the output volume of each jack.

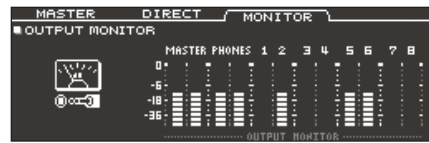

2 page (OTHER OUTPUT)

[F1] (MASTER) button

Specify the ambience and MFX output assignments for the PHONES jacks and MASTER OUT jacks (when OUTPUT ROUTING Master Out is set to “NORMAL”).



[F2] (DIRECT) button

Specify the ambience and MFX output assignments for the DIRECT OUT 1–8 jacks and MASTER OUT jacks (when OUTPUT ROUTING Master Out is set to “DIRECT”).



[F3] (MONITOR) button

Monitor the output volume of each jack.



* For more about the OUTPUT ROUTING Master Out parameter, refer to “Data List” (PDF).

3. Strike a pad or use the cursor [◀] [▶] buttons to select the pad or function that you want to edit.

| Display | Explanation |
|---------|-------------|
| K | KICK |
| S | SNARE |
| 1–4 | TOM1–4 |
| H | HI-HAT |
| C | CRASH1, 2 |
| R | RIDE |
| A | AUX1–4 |

| Display | Explanation |
|------------------|--|
| AMB | Ambience (p. 22) |
| MFX1–3 | Multi-effect 1–3 (p. 23) |
| SONG | Song (p. 14) |
| CLICK | Click (p. 13) and song click track (p. 15) output |
| MIXIN | Sound that is input to the MIX IN jack (p. 14) |
| USB IN MAIN, SUB | Sound that is input to the USB COMPUTER port (p. 31) |

4. Use the cursor [▲] [▼] buttons, [-] [+] buttons, or dial to select the output destination.

MEMO

To return to the default values, press the [F4] (DEFAULT) button.

5. Press the [KIT] button to return to the DRUM KIT screen.

Output Destination Setting Examples

Here are some examples of output destination settings.

MEMO

The MASTER OUT jacks (XLR type) and DIRECT OUT jacks (TRS phone type) are balanced. The MASTER OUT jacks (TRS phone type) are unbalanced (p. 9).

Example 1) Default settings

As the chart below illustrates, the PHONES jacks and the MASTER OUT jacks will output all sounds. Individual sounds are assigned to DIRECT OUT 1-8 jacks for individual sound control with a PA system.

| Jack | Output setting | Example destination |
|----------------|---------------------------------|---------------------|
| PHONES | All | Monitor headphones |
| MASTER OUT | All | Drum monitor |
| DIRECT OUT 1 | KICK | PA (external mixer) |
| DIRECT OUT 2 | SNARE | |
| DIRECT OUT 3 | HI-HAT | |
| DIRECT OUT 4 | RIDE | |
| DIRECT OUT 5/6 | TOM 1-4 (Stereo) | |
| DIRECT OUT 7/8 | CRASH 1, 2, AUX 1-4 (Stereo) | |

Example 2) Sending the same audio for monitoring and PA

With these settings, the same sound will be output from the PHONES jacks, the MASTER OUT jacks, and the DIRECT OUT 7/8 jacks.

The sound being monitored by the performer will be the same as the sound sent to the PA system.

* The master compressor and master EQ effects are not applied to DIRECT OUT.

| Jack | Output setting | Example destination |
|----------------|----------------|---------------------|
| PHONES | All | Monitor headphones |
| MASTER OUT | All | Drum monitor |
| DIRECT OUT 1 | - | - |
| DIRECT OUT 2 | - | - |
| DIRECT OUT 3 | - | - |
| DIRECT OUT 4 | - | - |
| DIRECT OUT 5/6 | - | - |
| DIRECT OUT 7/8 | All | PA (external mixer) |

Example 3) Performing while listening to a guide

All sound is sent from the PHONES jacks for monitoring.

By outputting CLICK (the click and song click track output) and USB IN SUB (the sound that is input to the USB COMPUTER port) only from headphones, the performer alone can hear the guide sound while they perform.

| Jack | Output setting | Example destination |
|----------------|---|---------------------|
| PHONES | All CLICK and USB IN SUB are output only to PHONES | Monitor headphones |
| MASTER OUT | Output only SONG and USB IN MAIN | PA (external mixer) |
| DIRECT OUT 1 | KICK | |
| DIRECT OUT 2 | SNARE | |
| DIRECT OUT 3 | HI-HAT | |
| DIRECT OUT 4 | RIDE | |
| DIRECT OUT 5/6 | TOM 1-4 (Stereo) | |
| DIRECT OUT 7/8 | CRASH 1, 2, AUX 1-4 (Stereo) | |

Making detailed settings for output routing

Here's how to make detailed settings for output routing to the MASTER OUT jacks, DIRECT OUT jacks, and PHONES jacks.

Reference

For details on the parameters that can be edited, refer to "Data List" (PDF).

1. In the SETUP MENU 1 screen (p. 42), press the [F1] (OUTPUT) button.
2. Press the PAGE [DOWN] button to access page 3 (OUTPUT ROUTING).

The routing screen appears.



3. Press a [F1] (ROUTING)–[F3] (ATT) button to select the item that you want to edit.

| Button | Explanation |
|-----------------------|--|
| [F1] (ROUTING) button | Specifies how the fader, pad equalizer/compressor, and master out output are applied or routed. |
| [F2] (LO CUT) button | Specifies whether the low-frequency region is cut from the output. The frequency setting is the same for each output. |
| [F3] (ATT) button | Specifies whether an attenuator is applied to the output from the DIRECT OUT jacks. If the ROUTING tab's Master Out setting is "DIRECT," this also applies to the MASTER OUT jacks. For more about the Master Out parameter, refer to "Data List" (PDF). |

MEMO

- To return to the default values, press the [F4] (DEFAULT) button.
- The LO CUT and ATT settings do not affect the USB audio output.

4. Press the [KIT] button to return to the DRUM KIT screen.

Routing parameter setting examples

| Parameter | Explanation |
|----------------------|---|
| Fader to Direct | When turned "OFF" <ul style="list-style-type: none"> • The output from the DIRECT OUT jacks is not affected by the panel faders. The output from the MASTER OUT jacks is not affected by the panel faders if the OUTPUT ROUTING Master Out setting is "DIRECT." The output of the PHONES jacks is always affected by the panel faders regardless of the Fader to Direct setting. • Separately from the balance that is adjusted at the PA, the performer can use the faders at hand to adjust the balance of the sound that they are monitoring. |
| | When turned "ON" <ul style="list-style-type: none"> • The output from the DIRECT OUT jacks bypasses the pad equalizer and pad compressor. The output from the MASTER OUT jacks bypasses the pad equalizer and pad compressor if the OUTPUT ROUTING Master Out setting is "DIRECT." • While the equalizer and compressor for each pad are adjusted at the PA, the performer can perform with the sound processed by the pad equalizer and pad compressor of each drum kit. |
| PadEq/Comp to Direct | <ul style="list-style-type: none"> • The output from the DIRECT OUT jacks bypasses the pad equalizer and pad compressor. • The output from the MASTER OUT jacks bypasses the pad equalizer and pad compressor if the OUTPUT ROUTING Master Out setting is "DIRECT." |

| Parameter | Explanation |
|-------------------|--|
| PadComp to Phones | When turned "OFF" <ul style="list-style-type: none"> The pad compressor does not apply to the output from the PHONES jacks. With settings such as shown in output destination setting example 2 (p. 43), you can hear the sound with full dynamics in your monitor headphones as you perform, yet use the pad compressor to reduce the dynamics for the drum monitor and the PA. |
| | With the "DIRECT" setting <ul style="list-style-type: none"> The master compressor and master EQ effects are not applied to the output from the MASTER OUT jacks, allowing you to use the MASTER OUT jacks as DIRECT OUT jacks (the setting of the [MASTER] knob is applied). This setting also applies to the output via USB audio to your computer. The PHONES jacks output the sound processed by the master compressor and master EQ. If you want the output of the MASTER OUT jacks to be output as direct output, assign the output to MASTER DIRECT in the PAD OUTPUT screen (DIRECT tab) and the OTHER OUTPUT screen (DIRECT tab). |

Reference

For other settings, refer to "Data List" (PDF).

Assigning Functions to Foot Switches or Pads (CONTROL)

Foot switches (BOSS FS-5U, FS-6; sold separately) or pads that are connected to the TD-50 can be assigned to control functions such as switching drum kits or switching set lists.

Reference

For details on the parameters that can be edited, refer to "Data List" (PDF).

Assigning a function to a footswitch

Connecting an FS-5U

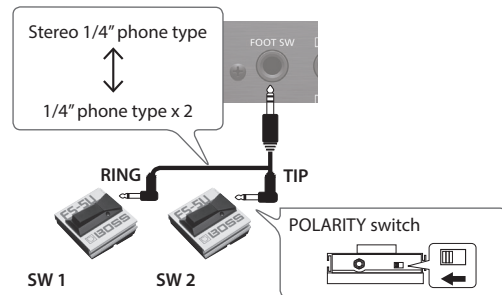

- * If you use a mono cable to connect a single FS-5U, it will operate as SW 2.
- * The FS-5L cannot be used.

Connecting an FS-6

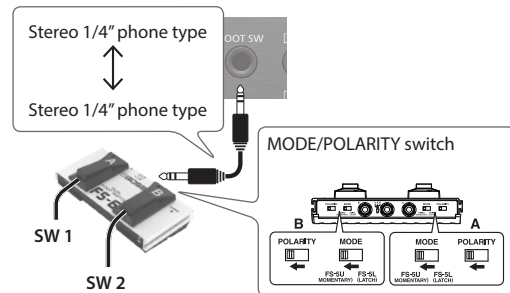

1. In the SETUP MENU 1 screen (p. 42), press the [F4] (CONTROL) button.

2. Press the [F1] (FOOT SW) button.

The FOOT SWITCH CONTROL screen appears.



3. Use cursor buttons to select a parameter, and use the [-] [+] buttons or the dial to edit the value.

MEMO

If you want to use a footswitch to switch drum kits in a set list (p. 33), assign the function of the footswitch to "KIT# DEC" or "KIT# INC," and press the [SET LIST] button to make it light. (Create a set list beforehand.)

4. Press the [KIT] button to return to the DRUM KIT screen.

Other Settings (OPTION)

Here you can make settings for the [PREVIEW] button, the MIX IN jack, and the display.

Reference

For details on the parameters that can be edited, refer to "Data List" (PDF).

1. In the SETUP MENU 1 screen (p. 42), press the [F3] (OPTION) button.

The option settings screen appears.



2. Press a [F1] (PREVIEW)–[F4] (GUIDE) button to select the item that you want to edit.

| Button | Explanation |
|-----------------------|---|
| [F1] (PREVIEW) button | Specifies how the sound is heard when you press the [PREVIEW] button. |
| [F2] (MIX IN) button | Makes settings for the MIX IN jack. |
| [F3] (LCD) button | Adjusts the contrast of the display. |
| [F4] (GUIDE) button | Shows/hides the guide that temporarily appears when you switch pages. |

3. Use cursor buttons to select a parameter, and use the [-] [+] buttons or the dial to edit the value.

4. Press the [KIT] button to return to the DRUM KIT screen.

Assigning functions to pads

You can assign a function to a pad that's connected to TRIGGER IN jack 13/AUX3 or 14/AUX4, or to a pad that supports digital connection and is assigned to AUX3/4.

1. In the **SETUP MENU 1** screen (p. 42), press the **[F4] (CONTROL)** button.

2. Press the **[F2] (PAD CTRL)** button.

The **PAD SWITCH CONTROL** screen appears.



3. Use cursor buttons to select a parameter, and use the **[-]** **[+]** buttons or the dial to edit the value.

MEMO

- If you don't want sound to be heard when you strike the pad, use **MIXER VOLUME** (p. 22) to set the AUX3 and AUX4 volume setting to "0." Alternatively, press the **[INSTRUMENT]** button and select "OFF" as the instrument for AUX3 and AUX4 (p. 19).
- If you want to use a pad to switch drum kits in a set list (p. 33), assign the function of the pad to "KIT# DEC" or "KIT# INC," and press the **[SET LIST]** button to make it light. (Create a set list beforehand.)

4. Press the **[KIT]** button to return to the **DRUM KIT** screen.

MIDI Settings (MIDI)

Here you can make MIDI settings for the entire TD-50.

Reference

For details on the parameters that can be edited, refer to "Data List" (PDF).

1. In the **SETUP MENU 2** screen (p. 42), press the **[F1] (MIDI)** button.

The **MIDI** screen appears.

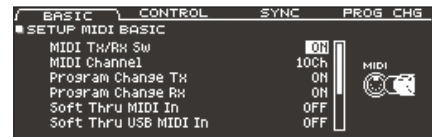

2. Press a **[F1] (BASIC)**–**[F4] (PROG CHG)** button to select the item that you want to edit.

| Button | Explanation |
|-------------------------------|---|
| [F1] (BASIC) button | Makes basic MIDI settings such as specifying the channel on which the TD-50 transmits and receives MIDI data. |
| [F2] (CONTROL) button | Specifies the MIDI messages that are transmitted or received to indicate the pad striking location or the position of the hi-hat pedal. |
| [F3] (SYNC) button | Specifies settings related to MIDI synchronization. |
| [F4] (PROG CHG) button | Lets you freely specify the correspondence between drum kits and the program changes that are transmitted and received. |

3. Use cursor buttons to select a parameter, and use the **[-]** **[+]** buttons or the dial to edit the value.

4. Press the **[KIT]** button to return to the **DRUM KIT** screen.

Viewing Information for the TD-50 Itself (INFO)

Here's how to view information for the TD-50 unit itself, such as its program version.

1. In the SETUP MENU 2 screen (p. 42), press the [F3] (INFO) button.

The information screen appears.

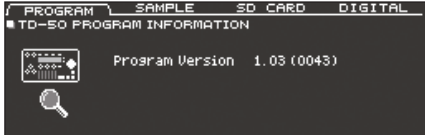

2. Press a [F1] (PROGRAM)–[F4] (DIGITAL) button to select the item that you want to edit.

| Button | Explanation |
|-----------------------|---|
| [F1] (PROGRAM) button | Displays the program version. |
| [F2] (SAMPLE) button | Displays the number of loaded user samples and the remaining amount of space for user samples in user memory. |
| [F3] (SD CARD) button | Displays the number of backup data, kit backup data, and recorded data that are saved on the SD card. |
| [F4] (DIGITAL) button | Displays the program version of the digital connection compatible pads that are connected to the TD-50. The FUNC button of the selected pad is blinking. |

3. Press the [KIT] button to return to the DRUM KIT screen.

Restoring the Factory Settings (FACTORY RESET)

The “Factory Reset” operation returns all data and settings stored in the TD-50 to their factory-set condition.

NOTE

When you execute this operation, all data and settings in the TD-50 will be lost. Before you proceed, you should save any important data and settings to your SD card (p. 39).

1. In the SETUP MENU 3 screen (p. 42), press the [F1] (FACTORY RESET) button.

The FACTORY RESET screen appears.

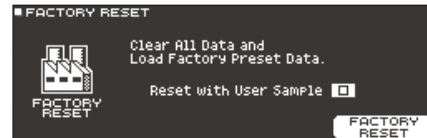

MEMO

If you want all user samples to also be returned to their factory-set state, use the [-] [+] buttons or the dial to add a check mark to “Reset with User Sample.” All user samples in user memory are overwritten by the factory-set data.

2. Press the [F5] (FACTORY RESET) button.

A confirmation message appears.



If you decide to cancel, select “CANCEL” and press the [ENTER] button.

3. Select “OK” and press the [ENTER] button.

The “Factory Reset” operation will be executed.

Appendix

List of Displayed Messages

Error Messages

| Message | Meaning | Action |
|--|---|---|
| Format SD Card Error! | Failed to format the SD card. | Insert an SD card correctly. Unlock the SD card. |
| Incorrect File! | The backup data or the kit backup data is damaged. | Do not use this data. |
| MIDI Buffer Full! | A large amount of MIDI messages were received in a short time, and could not be processed completely. | Confirm that the external MIDI device is properly connected. If the problem persists, reduce the amount of MIDI messages sent to the TD-50. |
| MIDI Offline! | A MIDI cable or USB cable is disconnected (alternatively, communication with the external MIDI device was interrupted for some reason). | Make sure that the MIDI cable or USB cable is not disconnected or broken. |
| No Backup Data! | There is no backup data on the SD card. | – |
| No Data! | You attempted to export a song for which recorded data does not exist. | Export a song for which recorded data exists. |
| No SD Card! | No SD card is in the SD card slot. | Insert an SD card correctly. |
| Rec Data Exists! Change Rec Number or Check Overwrite. | Recorded data exists. | Either change the recording-destination, or specify that the recorded data will be overwritten (p. 17). |
| Rec Data Full! | The storage capacity of the song recorder is full, and recording has stopped. Recording stopped because the maximum number of notes that can be recorded in one song was exceeded. | – |
| Sample Length Too Long! | The audio file is too long, and cannot be imported. | Files longer than 180 seconds cannot be imported. |
| Sample Length Too Short! | The audio file is too short, and cannot be imported. | In some cases, audio files shorter than one second cannot be imported. |
| SD Card is Locked! | The SD card is locked. The file attribute is read-only. | Unlock the SD card. Clear the read-only attribute of the file. |
| SD Card is not connected! | No SD card is in the SD card slot. | Insert an SD card correctly. |
| SD Card Media Error! | The contents of SD card are damaged. Failed to save recorded data. Failed to export the song. | Copy the necessary data from the SD card, and then format the SD card on the TD-50 (p. 41). If this does not solve the problem, try a different SD card. Check the lock status of the SD card. Check whether the file might be write-protected. |
| SD Card Memory Full! | There are no empty space on the SD card. | Delete unneeded data (p. 41). |
| System Overload! | The TD-50's processing could not keep up. | Reduce the number of notes that play simultaneously. |
| Unsupported format! | The TD-50 does not support this format. | Check whether this file format can be played (song (p. 14), user sample (p. 27)). |
| User Sample Does Not Exist! | User samples do not exist. | Select a location where user samples exist. |
| User Sample Exists! | User samples exist. | Delete the user samples, or select a vacant location. |
| User Sample Import Error! | The audio data to be imported is damaged. The data on the SD card is damaged. | Do not use this audio data. Do not use this SD card. |
| User Sample Memory Error! | The backup data or kit backup data including user samples is damaged. The data on the SD card is damaged. An empty user sample is assigned. (Only for 1 KIT SAVE) | Do not use this data. Do not use this SD card. You can't use 1 KIT SAVE for a kit to which empty user samples are assigned. |
| User Sample memory full! | There is no free user sample space. | Delete unneeded user sample (p. 29). |

Other Messages

| Message | Meaning | Action |
|---|--|--|
| USB Driver The modified settings will become effective after power off and restart. | The USB driver settings take effect when you turn the power of the TD-50 off and on again. | Turn the power of the TD-50 off and on again. |
| XStick always effective | Cross-stick technique is always enabled. | – |
| XStick switch available | The cross-stick switch is enabled. | In the DRUM KIT screen, press the [F4] (XSTICK) button to switch between sounding or not sounding the cross-stick sound (p. 13). |

Troubleshooting

| Problem | Items to check | Action | Page |
|--|--|---|----------------|
| Problems with sound | | | |
| A specific pad does not sound | Are the cables correctly connected to each pad and pedal? | Check the connections. | p. 9 |
| | Could the instrument be "OFF"? | Assign an instrument. | p. 19 |
| | Could the instrument's "Volume" be lowered? | Adjust the instrument's "Volume." | p. 22 *1 |
| | Have the settings for "OUTPUT" been made correctly? | Check the settings for "OUTPUT." | p. 42 |
| | Could the faders be lowered? | Adjust the settings of the faders. | p. 12 |
| | Could user samples have been deleted? | If you delete the user sample that's assigned to a pad, it will not produce sound. Either load the user sample once again, or assign a different instrument. | p. 27 |
| | Is the pad's "trigger type" set correctly? | Set the pad's "trigger type." | p. 35 |
| | Is the connection cable correctly connected to the TRIGGER INPUT jack or the DIGITAL TRIGGER IN port ? | Check the connections. | p. 9 |
| No sound/Insufficient volume | Is the product correctly connected to the external devices? | Check the connections. | p. 9 |
| | Could the product's volume be lowered? | | p. 12 |
| | Could the volume of the connected amplified speaker be lowered? | Adjust the volume to an appropriate level. | - |
| | Have you made the correct input selection on your audio system? | Check your audio system. | - |
| | Could the volume be lowered on the device connected to the MIX IN jack? | Adjust the volume to an appropriate level. | - |
| | Is the product's input level lowered? | Turn the [MIX IN] knob to an appropriate level. | p. 7 |
| | Could "Local Control" be "OFF"? | Set "Local Control" to "ON." | *1 |
| No sound when you strike a pad assigned to a TRIGGER IN jack / Trigger does not respond | If a pad connected to a DIGITAL TRIGGER IN port is assigned to the same trigger input as a pad connected to a TRIGGER IN jack, the sound of the pad that's connected to the TRIGGER IN jack is not output. | Disconnect the pad connection cable from the DIGITAL TRIGGER IN port. | p. 9 |
| No sound when you strike a pad connected to a DIGITAL TRIGGER IN port / Trigger does not respond | Is the trigger input set correctly? | After connecting the pad, specify the trigger input that it will play. | p. 9 |
| | Could you be using carbon or metal sticks? | Use wood or plastic sticks. Using carbon or metal sticks might make the sensor malfunction. | - |
| | Could you be using metal brushes? | Use nylon brushes. Using metal brushes might make the sensor malfunction, or might scratch the pad. | - |
| Problems with SD card | | | |
| SD card is connected but not recognized/Data is not visible | Is the SD card formatted correctly? | Format the SD card on this product. | p. 41 |
| Can't play MP3/WAV file | Does the product support the sampling frequency and bit rate of the MP3 file, or the sampling frequency and bit depth of the WAV file? | Use MP3/WAV files that the product supports. | p. 14 |
| | Playback may be unable to keep up if you raise the playback speed of a high bit-rate of MP3. | | - |
| Can't correctly set the A-B repeat times | When using a MP3 file, it might not be possible to play back the A-B repeat region correctly. | | - |
| Can't play or import an audio file | Is the audio file format correct? | Check the audio file format, file name, and file name extension. | p. 14 p. 27 |
| | Is the audio file in the correct location? | Check the location of the audio file. | p. 40 |
| | Could a large number of audio files be in the folder? | Keep the number of audio files in a folder to 200 or fewer. | - |
| Problems with USB | | | |
| Can't communicate with a computer | Is the USB cable connected correctly? | Check the connections. | p. 8 |
| | In order to transmit and receive audio as USB AUDIO, the USB driver must be installed. | Install the USB driver on your computer. | p. 30 |
| | Are you using a cable that supports USB 2.0? | The product cannot be used the cable that supports USB 3.0. Use the cable that supports USB 2.0. | - |
| | Have the settings for "Driver Mode" been made correctly? | Choose the setting that's appropriate for your situation. | p. 30 |
| Problems with MIDI | | | |
| No sound | Are the MIDI cables connected correctly? | Check the connections. | p. 9 |
| | Is the MIDI channel set correctly? | Set the MIDI channels of the product and external MIDI device to the same setting. | *1 |
| | Has the note number been set properly? | Set the pad's "NOTE NO." | *1 |

*1 Refer to "Data List" (PDF).

Main Specifications

Roland TD-50: Drum Sound Module

| | | | |
|--|--|--|---|
| Drum Kits | 100 | | |
| Instruments | More than 400 | | |
| Effect Types | Pad Compressor: each pad Pad Equalizer: each pad Room Type: 25 types | Reverb Type: 5 types Stereo Enhancer Multi-Effects: 3 systems, 30 types | Master Compressor Master Equalizer |
| User Sample Import | Number of User Sample: Maximum 500 (includes factory preloaded user samples) Sound Length (total): 24 minutes in mono, 12 minutes in stereo File formats that can be loaded: WAV (44.1 kHz, 16/24 bits) | | |
| Song Player (SD Card) | Audio File: WAV (44.1 kHz, 16/24 bits), MP3 | | |
| Recorder | Recording Method: Realtime Maximum Note Storage: approx. 40,000 notes Export File Format: WAV (44.1 kHz, 16 bits), SMF | | |
| Display | Graphic LCD 256 x 80 dots TRIGGER ACTIVITY Indicator (LED) | | |
| Faders | 8 (KICK, SNARE, TOMS, HI-HAT, CRASH, RIDE, AUX, AMBIENCE) | | |
| External Memory | SD Card (SDHC supported) | | |
| Connectors | TRIGGER IN jack x 14: 1/4-inch TRS phone type (Exclusion use with digital pad) DIGITAL TRIGGER IN port x 3: USB A type MASTER OUT (UNBALANCED) jacks (L/MONO, R): 1/4-inch phone type MASTER OUT (BALANCED) jacks (L, R): XLR type, balanced DIRECT OUT (BALANCED) jack x 8: 1/4-inch TRS phone type, balanced PHONES jack x 2: Stereo 1/4-inch phone type, Stereo miniature phone type MIX IN jack x 2: Stereo 1/4-inch phone type, Stereo miniature phone type MIDI (IN, OUT/THRU) connectors USB COMPUTER port: USB B type (USB Hi-Speed AUDIO/MIDI) FOOT SW jack: 1/4-inch TRS phone type AC IN jack | | |
| Number of USB Audio Record/ Playback Channels | Sampling Rate (Original): 44.1 kHz Sampling Rate (with Sampling rate converter): 96 kHz, 48 kHz Record: 10 channels Playback: 4 channels | | |
| Power Supply | AC 117 V, AC 220 V, AC 230 V, AC 240 V | | |
| Power Consumption | 30 W | | |
| Dimensions | 330 (W) x 255 (D) x 118 (H) mm 13 (W) x 10-1/16 (D) x 4-11/16 (H) inches | | |
| Weight | 3.3 kg/7 lbs 5 oz | | |
| Accessories | Quick Start Power Cord | | |
| Options (sold separately) | Pad: PD series, PDX series, BT-1 Cymbal: CY series Kick: KD series, KT series | Hi-Hat: VH-series Hi-Hat Control Pedal: FD series Acoustic Drum Trigger: RT series | Footswitch: BOSS FS-5U, FS-6 Personal Drum Monitor: PM-10 Drum Stand: MDS-50KV, MDS-50K |

* This document explains the specifications of the product at the time that the document was issued. For the latest information, refer to the Roland website.