

**th•mann**

SP 5600  
portable grand keyboard

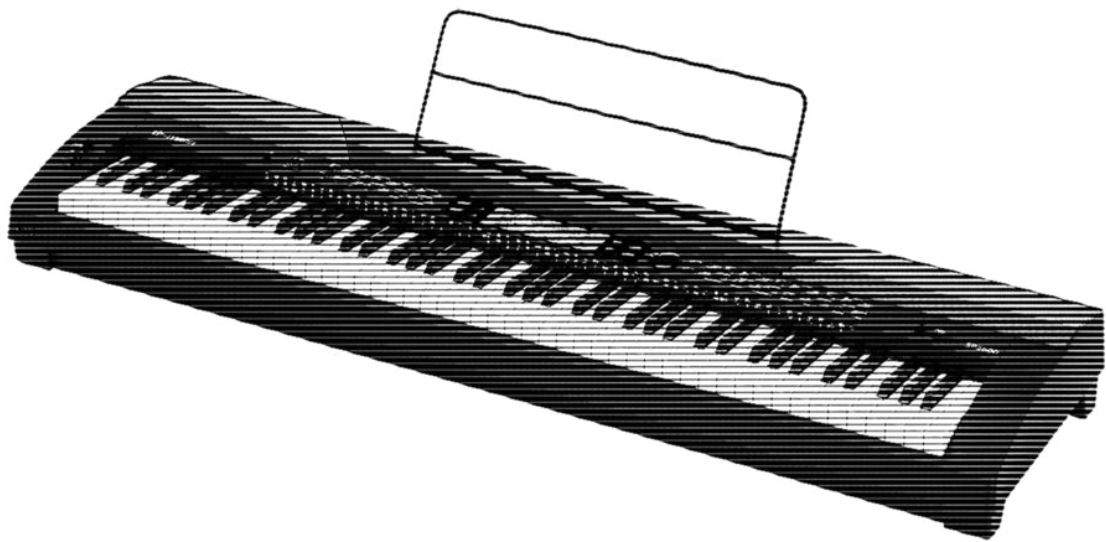

Musikhaus Thomann  
Thomann GmbH  
Hans-Thomann-Straße 1  
96138 Burgebrach  
Germany  
Telephone: +49 (0) 9546 9223-0  
E-mail: [info@thomann.de](mailto:info@thomann.de)  
Internet: [www.thomann.de](http://www.thomann.de)

16.11.2020, ID: 378054 (V5)

## Table of contents

<b>1</b>	<b>General information</b> .....	<b>5</b>
	1.1 Further information.....	5
	1.2 Notational conventions.....	5
	1.3 Symbols and signal words.....	6
<b>2</b>	<b>Safety instructions</b> .....	<b>7</b>
<b>3</b>	<b>Features</b> .....	<b>9</b>
<b>4</b>	<b>Assembly instructions</b> .....	<b>10</b>
<b>5</b>	<b>Connections and controls</b> .....	<b>11</b>
<b>6</b>	<b>Connection options</b> .....	<b>16</b>
<b>7</b>	<b>Quick start guide</b> .....	<b>18</b>
<b>8</b>	<b>Turning the keyboard on / off, setup</b> .....	<b>20</b>
	8.1 Turning the keyboard on / off.....	20
	8.2 Automatic shutdown.....	20
	8.3 Adjusting the volume.....	20
	8.4 Setting the touch sensitivity.....	20
	8.5 Sustain effect.....	21
	8.6 Digital effects.....	21
	8.7 Setting up the keyboard, Function menu.....	22
	8.7.1 Fine tuning.....	23
	8.7.2 Time signature.....	23
	8.7.3 Split point.....	23
	8.7.4 Pedal function.....	24
	8.7.5 Selection Harmony setting.....	25
	8.7.6 Equalizer.....	26
	8.7.7 Reverb effect.....	26
	8.7.8 Reverb volume.....	26
	8.7.9 Chorus effect.....	27
	8.7.10 Chorus volume.....	27
	8.7.11 MIDI receive channel.....	27
	8.7.12 MIDI send channel.....	28
	8.7.13 Automatic shutdown.....	28
	8.8 Loading / saving user settings.....	28
	8.9 Resetting user settings.....	29
	8.10 Deleting stored recordings.....	29
<b>9</b>	<b>Operating</b> .....	<b>30</b>
	9.1 Piano mode.....	30
	9.2 Transposing.....	30
	9.3 Playing demo sequences.....	30
	9.4 Style playing.....	31
	9.5 Playing songs.....	31

9.6	Metronome.....	32
9.7	Tempo.....	32
9.8	Mixer.....	32
9.9	Selecting voices.....	33
9.10	Dual mode.....	33
9.11	Split mode.....	34
9.12	TWINOVA.....	34
9.13	Harmony mode.....	35
9.14	Chord detection.....	36
9.15	Chord dictionary.....	39
9.16	Auto Accompaniment.....	41
9.17	Accompaniment track volume, muting.....	41
9.18	Fade in, Fade out.....	42
9.19	One Touch Setting.....	42
9.20	Performance Assistant.....	43
9.20.1	GUITAR mode.....	43
9.20.2	PIANO mode.....	44
9.21	Practising songs.....	44
9.22	Recording function.....	45
9.22.1	Recording preparation.....	46
9.22.2	Recording.....	46
9.22.3	Stopping recording.....	47
9.22.4	Playing a recording.....	47
9.22.5	Delete recording.....	47
9.23	MIDI function.....	48
9.24	USB storage medium.....	48
9.24.1	USB stick playback.....	49
9.24.2	Loading data from USB stick.....	49
9.24.3	Save data to USB stick.....	49
9.24.4	Deleting all data on a USB stick.....	50
9.25	Reset to factory defaults.....	50
<b>10</b>	<b>Technical specifications.....</b>	<b>51</b>
<b>11</b>	<b>Plug and connection assignment.....</b>	<b>53</b>
<b>12</b>	<b>Troubleshooting.....</b>	<b>54</b>
<b>13</b>	<b>Appendix.....</b>	<b>55</b>
13.1	Song list.....	55
13.2	Styles list.....	57
13.3	Voice list.....	62
13.4	Demo list.....	71
13.5	MIDI implementation chart.....	72
<b>14</b>	<b>Protecting the environment.....</b>	<b>74</b>

# 1 General information

This user manual contains important information on the safe operation of the device. Read and follow all safety notes and all instructions. Save this manual for future reference. Make sure that it is available to all persons using this device. If you sell the device to another user, be sure that they also receive this manual.

Our products and user manuals are subject to a process of continuous development. We therefore reserve the right to make changes without notice. Please refer to the latest version of the user manual which is ready for download under [www.thomann.de](http://www.thomann.de).

## 1.1 Further information

On our website ([www.thomann.de](http://www.thomann.de)) you will find lots of further information and details on the following points:

Download	This manual is also available as PDF file for you to download.
Keyword search	Use the search function in the electronic version to find the topics of interest for you quickly.
Online guides	Our online guides provide detailed information on technical basics and terms.
Personal consultation	For personal consultation please contact our technical hotline.
Service	If you have any problems with the device the customer service will gladly assist you.

## 1.2 Notational conventions

This manual uses the following notational conventions:

### Letterings

The letterings for connectors and controls are marked by square brackets and italics.

**Examples:** *[VOLUME]* control, *[Mono]* button.

### Displays

Texts and values displayed on the device are marked by quotation marks and italics.

**Examples:** '24ch', 'OFF'.

## Instructions

The individual steps of an instruction are numbered consecutively. The result of a step is indented and highlighted by an arrow.

### Example:

1. ➤ Switch on the device.
2. ➤ Press [Auto].  
⇒ Automatic operation is started.
3. ➤ Switch off the device.

## Cross-references

References to other locations in this manual are identified by an arrow and the specified page number. In the electronic version of the manual, you can click the cross-reference to jump to the specified location.



Example: See ➤ 'Cross-references' on page 6.

## 1.3 Symbols and signal words

In this section you will find an overview of the meaning of symbols and signal words that are used in this manual.

Signal word	Meaning
<b>DANGER!</b>	This combination of symbol and signal word indicates an immediate dangerous situation that will result in death or serious injury if it is not avoided.
<b>CAUTION!</b>	This combination of symbol and signal word indicates a possible dangerous situation that can result in minor injury if it is not avoided.
<b>NOTICE!</b>	This combination of symbol and signal word indicates a possible dangerous situation that can result in material and environmental damage if it is not avoided.

Warning signs	Type of danger
	Warning – high-voltage.
	Warning – danger zone.

## 2 Safety instructions

### Intended use

This device is intended to be used for electronic sound generation using a piano keyboard. Use the device only as described in this user manual. Any other use or use under other operating conditions is considered to be improper and may result in personal injury or property damage. No liability will be assumed for damages resulting from improper use.

This device may be used only by persons with sufficient physical, sensorial, and intellectual abilities and having corresponding knowledge and experience. Other persons may use this device only if they are supervised or instructed by a person who is responsible for their safety.

### Safety



#### **DANGER!**

##### **Danger for children**

Ensure that plastic bags, packaging, etc. are disposed of properly and are not within reach of babies and young children. Choking hazard!

Ensure that children do not detach any small parts (e.g. knobs or the like) from the unit. They could swallow the pieces and choke!

Never let children unattended use electrical devices.



#### **DANGER!**

##### **Electric shock caused by high voltages inside**

Within the device there are areas where high voltages may be present. Never remove any covers.

There are no user-serviceable parts inside.

Do not use the device if covers, protectors or optical components are missing or damaged.



#### **CAUTION!**

##### **Possible hearing damage**

With loudspeakers or headphones connected, the device can produce volume levels that may cause temporary or permanent hearing impairment.

Do not operate the device permanently at a high volume level. Decrease the volume level immediately if you experience ringing in your ears or hearing impairment.



### **NOTICE!**

#### **Operating conditions**

This device has been designed for indoor use only. To prevent damage, never expose the device to any liquid or moisture. Avoid direct sunlight, heavy dirt, and strong vibrations.

Only operate the device within the ambient conditions specified in the chapter 'Technical specifications' of this user manual. Avoid heavy temperature fluctuations and do not switch the device on immediately after it was exposed to temperature fluctuations (for example after transport at low outside temperatures).

Dust and dirt inside can damage the unit. When operated in harmful ambient conditions (dust, smoke, nicotine, fog, etc.), the unit should be maintained by qualified service personnel at regular intervals to prevent overheating and other malfunction.



### **NOTICE!**

#### **External power supply**

The device is powered by an external power supply. Before connecting the external power supply, ensure that the input voltage (AC outlet) matches the voltage rating of the device and that the AC outlet is protected by a residual current circuit breaker. Failure to do so could result in damage to the device and possibly the user.

Unplug the external power supply before electrical storms occur and when the device is unused for long periods of time to reduce the risk of electric shock or fire.



### 3 Features

- 88 keys with hammer action
- Multifunction LED display
- Pitch bend wheel
- 128-voice polyphony
- 600 voices
- 230 programmed styles, 10 user styles
- 120 programmed songs, 5 user songs
- 5 demo songs
- Reverb, Chorus and Sustain effects
- Master EQ
- Sequencer
- Accompaniment and recording function
- Learning function and chord library
- Split and duo mode
- Metronome
- Transpose function
- Built-in speakers
- USB port
- Automatic shutoff
- Sustain pedal, music stand and 12 V power adapter included

## 4 Assembly instructions

Unpack and check carefully there is no transportation damage before using the unit. Keep the equipment packaging. To fully protect the product against vibration, dust and moisture during transportation or storage use the original packaging or your own packaging material suitable for transport or storage, respectively.

Set up the device in the desired location.

### Power supply

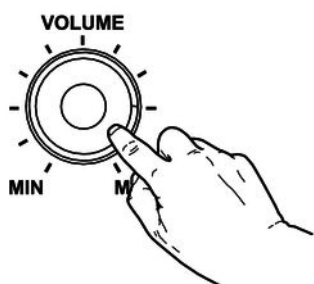

The unit is powered by the included 12 V power supply. Make sure that the device is turned off before you connect it to the power supply or disconnect it.

Turn the volume control counter-clockwise to minimum before connecting the device to the power supply or to other devices. This is to protect the speakers from damage.

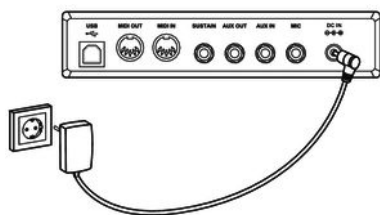

Connect the cable from the power adapter outlet to the input socket [DC IN] on the rear panel of the device. Plug the plug of the power cord into a properly wired and earthed mains wall outlet.

## 5 Connections and controls

### Overview

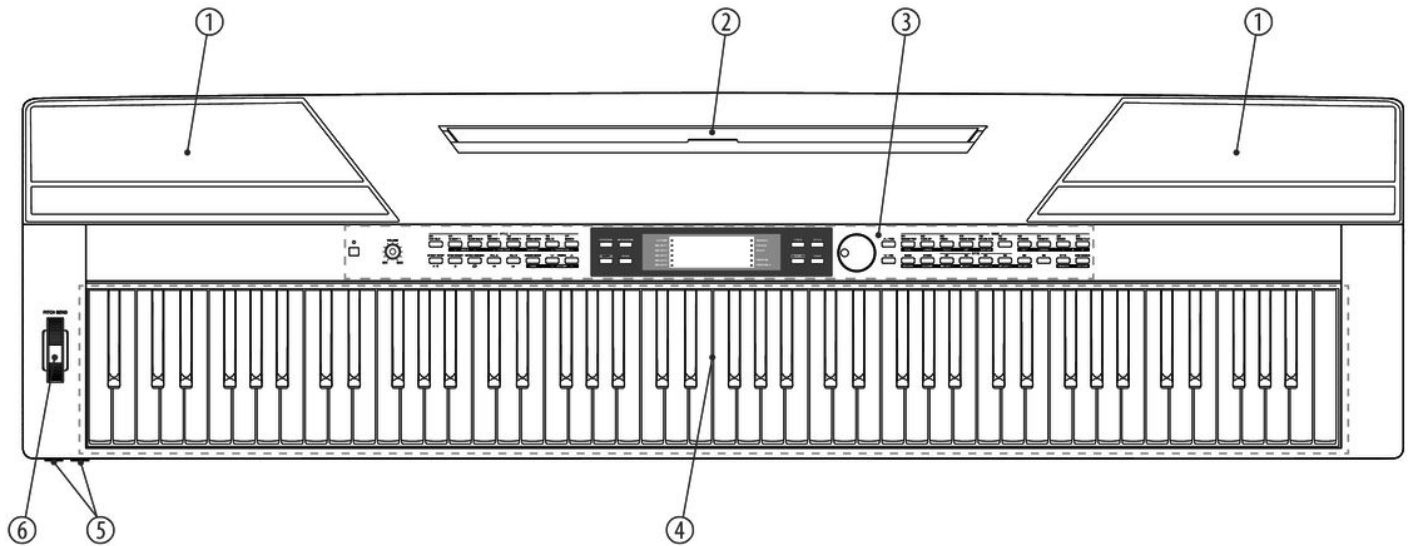

- |   |   |
|---|---|
| 1 | Built-in speakers.                            |
| 2 | Music stand holder.                           |
| 3 | Control panel with function keys and display. |
| 4 | Claviature with 88 keys.                      |
| 5 | 2 × connection sockets for headphones.        |
| 6 | Pitch bend wheel for changing the pitch.      |

## Operating panel

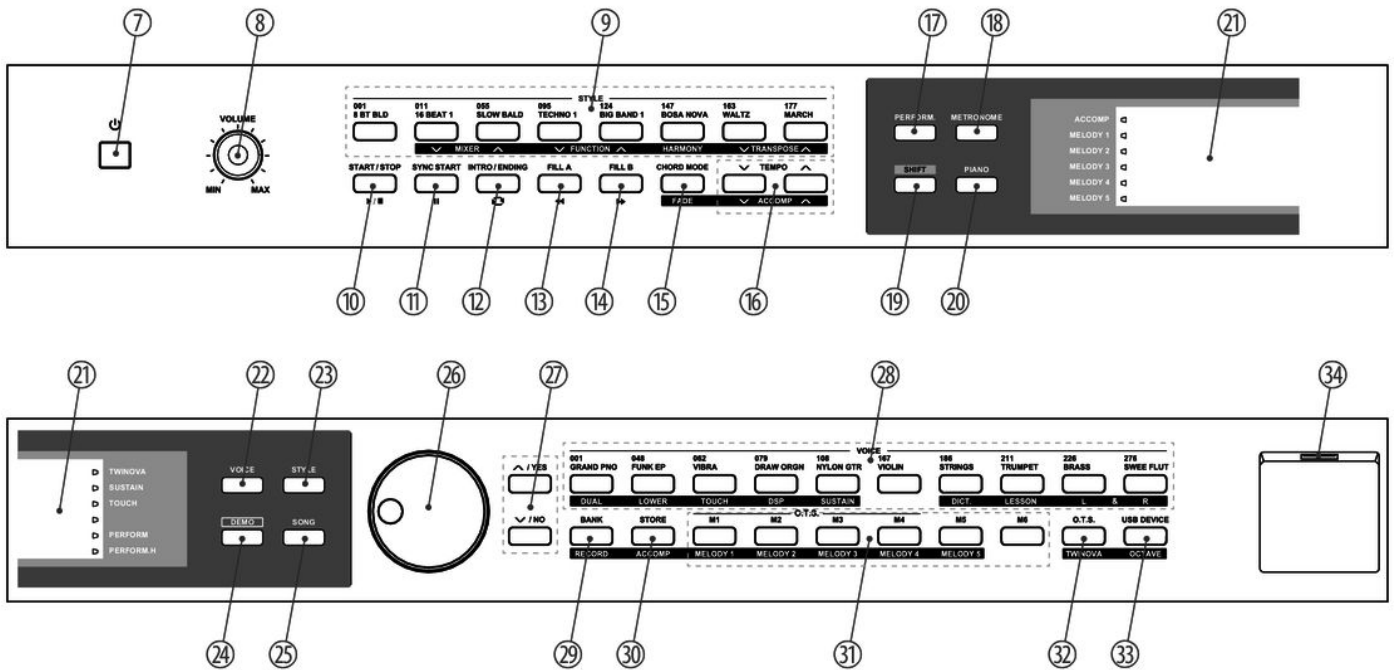

7	Button to turn the device on and off.
8	[VOLUME] Rotary volume control.
9	[STYLE] Single button function: direct Style selection. Button function while pressing the [SHIFT] button: <ul style="list-style-type: none"> <li>[MIXER] To open the Mixer menu.</li> <li>[FUNCTION] To open the Function menu.</li> <li>[HARMONY] Enabling / disabling the Harmony mode.</li> <li>[TRANSPOSE] Transposing the piano keys in semitone steps.</li> </ul>
10	[START / STOP] To start / stop the playback of demo songs or styles.
11	[SYNC START] Enabling / disabling the Sync start function in accompaniment and recording mode.
12	[INTRO/ENDING] Inserting an intro / ending in accompaniment mode.

13	[FILL A] Inserting Fills in accompaniment mode.
14	[FILL B] Inserting Fills in accompaniment mode.
15	[CHORD MODE]   [FADE] Single button function: Enabling / disabling the Chord mode. Button function while pressing the [SHIFT] button: Enabling / disabling the Fade function in accompaniment mode.
16	[TEMPO]   [ACCOMP] Single button function: Increasing / decreasing playback tempo. Button function while pressing the [SHIFT] button: Setting the accompaniment track volume.
17	[PERFORM] Enabling / disabling the Performance assistant.
18	[METRONOME] Enabling / disabling the Metronome.
19	[SHIFT] Enabling the second function of dual function buttons.
20	[PIANO] Calling Piano mode.
21	Display.
22	[VOICE] Calling Voice mode.
23	[STYLE] Calling Style mode.
24	[DEMO] Calling Demo mode.
25	[SONG] Calling Song mode.
26	Jog dial for selecting functions, parameters and values.
27	▲   [YES]: Increasing parameter selection and displayed value by one. ▼   [NO]: Decreasing parameter selection and displayed value by one.

28	<p><i>[VOICES]</i></p> <p>Single button function: direct Voice selection.</p> <p>Button function while pressing the <i>[SHIFT]</i> button:</p> <ul style="list-style-type: none"><li>■ <i>[DUAL]</i> Enabling / disabling Dual mode (Layer function).</li><li>■ <i>[LOWER]</i> Enabling / disabling Lower mode (Split function).</li><li>■ <i>[TOUCH]</i> Opening the menu to adjust the touch sensitivity of the keyboard.</li><li>■ <i>[DSP]</i> Turning digital effects on and off.</li><li>■ <i>[SUSTAIN]</i> Enabling / disabling the Sustain function.</li><li>■ <i>[DICT]</i> Opening chord dictionary.</li><li>■ <i>[LESSON]</i> Enabling / disabling the Lesson mode.</li><li>■ <i>[L]</i> Selecting the left hand in Lesson mode.</li><li>■ <i>[R]</i> Selecting the right hand in Lesson mode.</li></ul>
29	<p><i>[BANK]   [RECORD]</i></p> <p>Single button function: Selecting memory bank.</p> <p>Button function while pressing the <i>[SHIFT]</i> button: Enabling / disabling the Recording mode.</p>
30	<p><i>[STORE]   [ACCOMP]</i></p> <p>Single button function: Saving current values as user setting.</p> <p>Button function while pressing the <i>[SHIFT]</i> button: Record enabling accompaniment track.</p>
31	<p><i>[M1] ... [M6]   [MELODY 1] ... [MELODY 5]</i></p> <p>Single button function: Calling up user settings M1 ... M5 (in O.T.S. mode M1 ... M4).</p> <p>Button function while pressing the <i>[SHIFT]</i> button: Record enabling melody tracks 1 ... 5.</p>
32	<p><i>[O.T.S.]   [TWINOVA]</i></p> <p>Single button function: Enabling / disabling Single-finger mode (One Touch Setting).</p> <p>Button function while pressing the <i>[SHIFT]</i> button: Enabling / disabling the TWINOVA mode.</p>
33	<p><i>[USB DEVICE]   [OCTAVE]</i></p> <p>Single button function: Opening the menu for adjusting the USB functions.</p> <p>Button function while pressing the <i>[SHIFT]</i> button: Octaving the keyboard in TWINOVA mode.</p>
34	<p>USB interface for connecting a USB device.</p>

## Rear panel connections

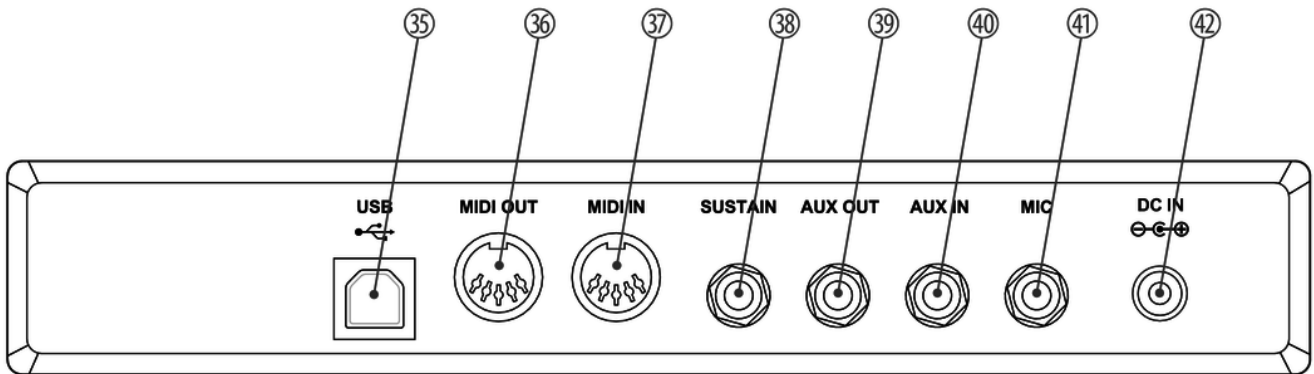

35	[USB] USB interface to connect a computer.
36	[MIDI OUT] MIDI out for connecting an external MIDI device.
37	[MIDI IN] MIDI in for connecting an external MIDI device.
38	[SUSTAIN] Pedal connecting socket (1/4" phone jack).
39	[AUX OUT] Output socket for connecting the device to an amplifier, stereo system, mixer or recording device (1/4" phone jack).
40	[AUX IN] Input socket for connecting an external audio device (e.g. MP3 or CD player) (1/4" phone jack).
41	[MIC] Input socket for connecting a microphone.
42	[DC IN] Connection for the power adapter.

## 6 Connection options

### Headphones

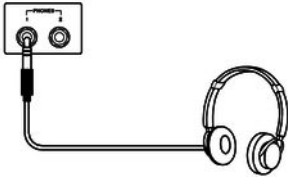

To the left beneath the keyboard you find the headphones outlets 1 and 2.

Connecting headphones (not supplied) to outlet 2 mutes the speakers.

When using output 1 You hear the sound through headphones and speakers.

### External audio devices via AUX OUT

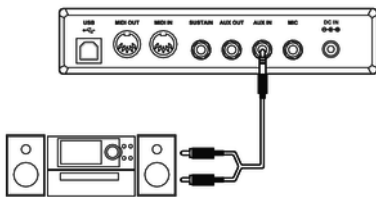

Use the [AUX OUT] socket to connect the keyboard to an amplifier, stereo device, mixing console or recording device. Plug one end of the audio cable into the [AUX OUT] socket on the rear panel of the keyboard and the other end into the input of the respective audio device.



#### NOTICE!

To prevent damage to the speakers, turn the volume down to 'Minimum' before you connect other devices to the keyboard.

### External audio devices via AUX IN

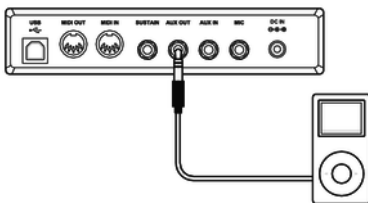

Use the [AUX IN] socket to connect a, for example, CD or MP3 player to the keyboard. So you can playback music through the internal speakers of the keyboard and simultaneously play along to it. Plug one end of the audio cable into the [AUX IN] socket on the rear panel of the keyboard and the other end into the output of the respective audio device.

### Computer via USB

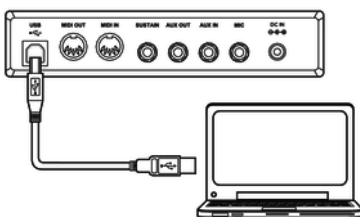

You can connect the keyboard to exchange data with a PC via the USB port. This also allows the transfer of MIDI files.



#### NOTICE!

Do not set the USB interface as the in and output at the same time in the computer software. Otherwise, there will be overlap when playing the keyboard.



**MIDI device via MIDI IN**

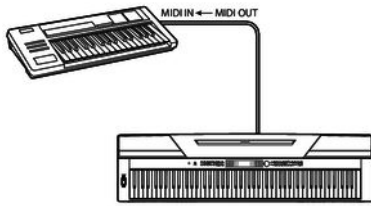

Use the MIDI interface [MIDI IN] to receive MIDI data from an external MIDI device.

**MIDI device via MIDI OUT**

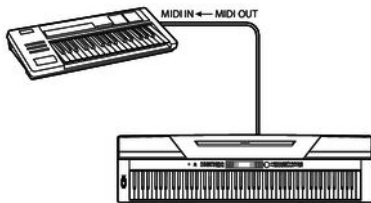

Use the MIDI interface [MIDI OUT] to send MIDI data to an external MIDI device.

**Sustain pedal**

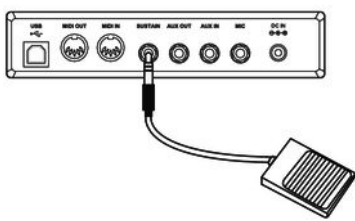

Use the connection socket [SUSTAIN] to connect a sustain pedal to the keyboard.

**Microphone**

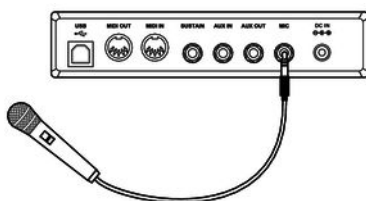

Use the connection socket [MIC] to connect a dynamic microphone (1/4" jack) to the device.

**Pedaly**

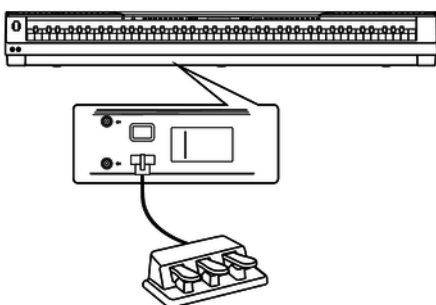

Use the connection socket on the bottom of the keyboard to connect the triple-pedal (Sustain, Sostenuto and Soft) of the optional Thomann original stand (item no. 352262).

## 7 Quick start guide

In order to provide you with a quick introduction, the main functions of the keyboard are described in brief in this chapter. A detailed description of the setting options can be found in the chapters ↪ *Chapter 9 'Operating' on page 30* and ↪ *Chapter 8 'Turning the keyboard on / off, setup' on page 20*.

### Turning the keyboard on / off

Press the power button on the left of the operating panel to turn the device on and off. The display shows 'Loading!'. The keyboard is immediately operational.

### Adjusting the volume

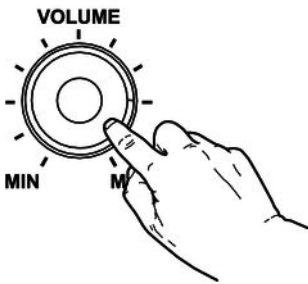

Adjust the rotary control [VOLUME] for a pleasant volume for playback and practising. Turn this control clockwise to increase the volume. Turn it counter-clockwise to reduce volume.

### Playing demo sequences

The demo sequences stored in the device show the sound and the pitch range of the keyboard.

1. ➤ Press [DEMO] to start playing the demo sequences in a continuous loop.
2. ➤ Use [YES] and [NO] to toggle between the five demo sequences (see ↪ *Chapter 13.4 'Demo list' on page 71*).
3. ➤ Press [DEMO] again or [START/STOP] to stop playing the demo sequences.

### Playing voices

The keyboard features a selection of 600 authentic voices, see ↪ *Chapter 13.3 'Voice list' on page 62*.

1. ➤ Press [VOICE] or one of the direct selection buttons to activate the last set or a desired voice directly.
  - ⇒ The display shows the name and number of the first right hand voice (main voice), e.g. 'VOICE R1', '001', 'GrandPno'.
2. ➤ Use [YES] and [NO], the jog dial or a direct select button to assign another voice.

Press the [VOICE] button repeatedly to toggle between the upper and lower voice of a direct selection button.

In dual and split mode, you toggle between the first and second right hand voice and the left hand voice by repeatedly pressing the [VOICE] button: 'VOICE R1', 'VOICE R2' and 'VOICE L', see the following chapters for Dual and Split mode.

## Style playing

The styles stored in the keyboard are used to support your own playing at performances, while practising and recording.

1. ▶ Press *[STYLE]* to activate the Style mode.
2. ▶ Use *[YES]* and *[NO]*, the jog wheel or a direct select button to enable the desired style directly (see [Chapter 13.2 'Styles list' on page 57](#)).
3. ▶ Press *[START/STOP]* to start or stop style playback.

## Playing songs

The keyboard offers a choice of 120 songs to accompany your playing at performances, while practising and recording. In addition, five tracks for your own recordings are available.

1. ▶ Press *[SONG]* to start playing the songs in a continuous loop.
2. ▶ Use *[YES]* and *[NO]* to toggle between the stored songs (see [Chapter 13.1 'Song list' on page 55](#)).
3. ▶ Press *[START/STOP]* to start or stop song playback.
4. ▶ Press *[STYLE]* or *[VOICE]* to exit the song mode.

## Recording songs

You can record up to five own tracks with the keyboard and store them in the internal memory.

1. ▶ Hold down *[SHIFT]* and press *[RECORD]* to enable the recording mode.
2. ▶ Use *[YES]* and *[NO]* or the jog dial to select a free memory location for the recording.
3. ▶ Hold down *[SHIFT]* and press *[RECORD]* again to record-enable the keyboard.
4. ▶ The recording starts as soon as you play the first tone or chord or press *[START/STOP]*.
5. ▶ Hold down *[SHIFT]* and press *[RECORD]* again to end the recording and to play the recorded sequence in an endless loop.
6. ▶ To disable the recording mode, hold down *[SHIFT]* and press *[RECORD]*.

## 8 Turning the keyboard on / off, setup

### 8.1 Turning the keyboard on / off

Press the power button on the left of the operating panel to turn the device on and off. The display shows 'Loading!'. The keyboard is immediately operational.



*If the display does not light up after switching on the keyboard, check the power supply.*

*If you hear nothing coming from the speakers, the volume may be set to 'minimum'.*

### 8.2 Automatic shutdown

If the keyboard is not in use, it shuts off automatically after 30 minutes. To adjust or deactivate the automatic shutdown, press [SHIFT] and [FUNCTION] twice. The time window can then be set via [YES] and [NO].

To turn the device on again after an automatic shutdown, press the on / off switch to the left of the panel.

### 8.3 Adjusting the volume

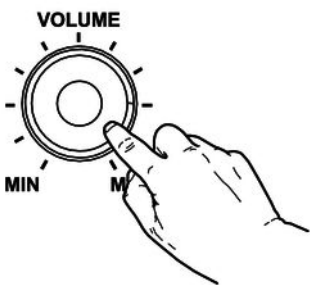

Adjust the rotary control [VOLUME] for a pleasant volume for playback and practising. Turn this control clockwise to increase the volume. Turn it counter-clockwise to reduce volume.

### 8.4 Setting the touch sensitivity

With this function you can adjust the touch response of the keyboard at four levels.

1. ➤ Hold down [SHIFT] and press [TOUCH] to open the menu for adjusting the touch sensitivity.
2. ➤ Adjust the touch sensitivity with [YES] and [NO] or with the jog dial.
3. ➤ Press [YES] and [NO] simultaneously to restore the default setting '002'.

Parameter	Meaning
'OFF'	Touch sensitivity is off.
'001'	Soft In this setting, the volume is lower than usual even when playing with a soft touch.
'002'	Normal This setting corresponds to the usual touch response of a clavature.
'003'	Hard In this setting, the volume is higher than usual even when playing with a hard touch.

## 8.5 Sustain effect

This feature allows you to assign a general Sustain to the keyboard. When the Sustain function is turned on, all tones played on the keyboard linger.

1. ➤ Hold down *[SHIFT]* and press *[RECORD]* to add the effect.
2. ➤ Hold down *[SHIFT]* and press *[RECORD]* again to disable the effect.

## 8.6 Digital effects

The DSP functions let you simulate the acoustic effects under different environmental conditions.

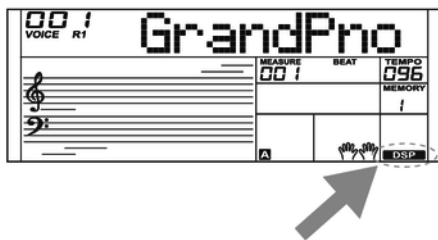

1. ➤ Hold down *[SHIFT]* and press *[DSP]* to enable the function.  
⇒ The icon 'DSP' appears on the display.

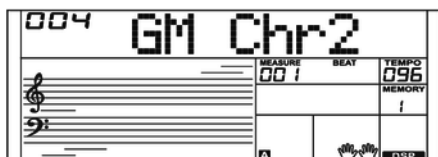

2. ➤ Hold down *[SHIFT]* and press *[FUNCTION] ▲* or *[FUNCTION] ▼* until the display shows 'GM Chr2'.
3. ➤ Turn the jog dial within 3 seconds to select the desired effect.

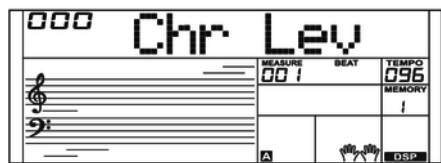

4. ➤ Hold down *[SHIFT]* and press *[FUNCTION]* ▲ or *[FUNCTION]* ▼ until the display shows 'Chr Lev'.
5. ➤ Select with the jog dial the desired effect strength between 000...127.
6. ➤ Hold down *[SHIFT]* and press *[DSP]* again to disable the function.
  - ⇒ The 'DSP' icon goes out.

### 8.7 Setting up the keyboard, Function menu

Hold down *[SHIFT]* and press *[FUNCTION]* ▲ or *[FUNCTION]* ▼ to open the Function menu. Select the desired sub menu using the buttons *[FUNCTION]* ▲ or *[FUNCTION]* ▼. You can then change the following parameters using the jog dial or *[YES]* and *[NO]*.

Option	LCD	Control range	Default value
Fine tuning	'Tune'	-50 ... 50	000
Time signature	'Beat'	0, 2 ... 9	004
Split point	'Split Pt'	1 ... 88	034
Pedal function	'SPd'	SUST, SOFT, St/T, MEM	SUST
	'UPd'	SOFT, St/T, MEM	SOFT
Selection Harmony setting	'HAR TYPE'	Duet, Standard Trio, Full Chord, Rock Duet, Country Duet, Country Trio, Block, 4 Close 1, 4 Close 2, 4 Open, 1+5, Octave 1, Octave 2, Strum, Echo 1, Echo 2, Echo 3, Echo 4, Tremolo 1, Tremolo 2, Tremolo 3, Tremolo 4, Trill 1, Trill 2, Trill 3, Trill 4	Duet
Equalizer	'EQ TYPE'	Pop, Rock, Class, Jazz, Dance, Reset	Reset
Reverb effect	'Rev TYPE'	Room 1, Room 2, Room 3, Hall 1, Hall 2, Hall 3, Chr 1, Chr 2, Del, PanD	Hall 1
Reverb volume	'Rev Lev'	0 ... 127	depending on the selected voice
Chorus effect	'Chr TYPE'	Chorus 1, Chorus 2, GM Chr 1, GM Chr 2, Flanger 1, Flanger 2, Rotary 2	GM Chr 2
Chorus volume	'Chr Lev'	0 ... 127	depending on the selected voice
MIDI receive channel	'Midi In'	1 ... 16, ALL	ALL
MIDI send channel	'Midi Out'	1 ... 16	001
Automatic shutoff	'POWER OFF'	030, 060, OFF	030



*If you don't press any key within five seconds after entering the function menu, the menu is automatically closed.*

### 8.7.1 Fine tuning

With this function you can fine tune the entire claviature in cent steps.

1. ➤ Use *[FUNCTION]* ▲ or *[FUNCTION]* ▼ to change into the 'Tune' menu. The current setting appears on the display.
2. ➤ Adjust the pitch using *[YES]* and *[NO]* or the jog dial in a range from -50 to +50 cents. Each time a key is pressed, the value changes by 1 cent.
3. ➤ Press *[YES]* and *[NO]* simultaneously to restore the default pitch.

### 8.7.2 Time signature

With this function you can set the time signature in a range from 0 to 9.

1. ➤ Use *[FUNCTION]* ▲ or *[FUNCTION]* ▼ to change into the 'Beat' menu. The current setting appears on the display.
2. ➤ Adjust the time signature with *[YES]* and *[NO]* or with the jog dial.
3. ➤ Press *[YES]* and *[NO]* simultaneously to restore the time signature standard value '004'.

### 8.7.3 Split point

Using this function you can select a point to split the whole claviature into two areas.

1. ➤ Use *[FUNCTION]* ▲ or *[FUNCTION]* ▼ to change into the 'Split Pt' menu. The display shows the current setting.
2. ➤ Specify the desired split point using the buttons *[YES]* and *[NO]* or the jog dial. The keys to the right of this point are the right hand area, the keys of the other sides are the left hand area (chord area).
3. ➤ Press *[YES]* and *[NO]* simultaneously to restore the split point standard value 'F#3'.



*In TWINOVA mode, the default split point is E3 (32) and can only be determined by the user between C3 and C6 (28 to 64).*

### 8.7.4 Pedal function

With this function you can assign the pedal function.

1. Use *[FUNCTION]* ▲ or *[FUNCTION]* ▼ to change into one of the menus 'SPd' (Sustain) or 'UPd' (Soft). The current setting appears on the display.
2. Use *[YES]* and *[NO]* or the jog dial to assign the desired pedal function:

Sustain pedal (enclosed)	Display	Soft pedal (left pedal of the optional SP-5600 stand)	Display
Sustain pedal	'SPd Sust'	Soft pedal	'UPd Soft'
Soft pedal	'SPd Soft'	Enabling / disabling the accompaniment track	'UPd St/T'
Enabling / disabling the accompaniment track	'SPd St/T'	Controlling the memory function	'UPd Mem'
Controlling the memory function	'SPd Mem'		

3. Press *[YES]* and *[NO]* simultaneously to restore the pedal function standard value 'Soft' or 'Sust'.



### 8.7.5 Selection Harmony setting

With this function you can pre-select a harmony setting.

1. Use [FUNCTION] ▲ or [FUNCTION] ▼ to change into the 'HAR TYPE' menu. The current setting appears on the display.
2. Use [YES] and [NO] or the jog dial to select the desired parameter:
  - 'Duet'
  - 'Standard Trio'
  - 'Full Chord'
  - 'Rock Duet'
  - 'Country Duet'
  - 'Country Trio'
  - 'Block'
  - '4 Close 1'
  - '4 Close 2'
  - '4 Open'
  - '1+5'
  - 'Octave1'
  - 'Octave2'
  - 'Strum'
  - 'Echo1'
  - 'Echo2'
  - 'Echo3'
  - 'Echo4'
  - 'Tremolo1'
  - 'Tremolo2'
  - 'Tremolo3'
  - 'Tremolo4'
  - 'Trill1'
  - 'Trill2'
  - 'Trill3'
  - 'Trill4'
3. Press [YES] and [NO] simultaneously to load the standard value 'Duet'.

### 8.7.6 Equalizer

With this function you can pre-select a certain tone colour.

1. ➤ Use *[FUNCTION]* ▲ or *[FUNCTION]* ▼ to change into the *[EQ TYPE]* menu. The current setting appears on the display.
2. ➤ Use *[YES]* and *[NO]* or the jog dial to select the desired presetting:
  - 'Pop'
  - 'Rock'
  - 'Class'
  - 'Jazz'
  - 'Dance'
  - 'Reset'
3. ➤ Press *[YES]* and *[NO]* simultaneously to load the standard value 'Reset' (EQ off).

### 8.7.7 Reverb effect

With this function you can turn on the Reverb effect and select the effect type.

1. ➤ Use *[FUNCTION]* ▲ or *[FUNCTION]* ▼ to change into the 'Rev TYPE' menu. The current setting appears on the display.
2. ➤ Use *[YES]* and *[NO]* or the jog dial to select the desired parameter:
  - 'Room1'
  - 'Room2'
  - 'Room3'
  - 'Hall1'
  - 'Hall2'
  - 'Hall3'
  - 'Chr1'
  - 'Chr2'
  - 'Del'
  - 'PanD'
3. ➤ Press *[YES]* and *[NO]* simultaneously to load the standard value 'Hall1'.

### 8.7.8 Reverb volume

With this function you can set the Reverb effects volume in a range from 0 to 127.

1. ➤ Use *[FUNCTION]* ▲ or *[FUNCTION]* ▼ to change into the 'RevLev' menu. The current setting appears on the display.
2. ➤ Adjust the effects ratio with the buttons *[YES]* and *[NO]* or with the jog dial.
3. ➤ Press *[YES]* and *[NO]* simultaneously to reset the effects ratio to the standard value (depending on the selected voice).

### 8.7.9 Chorus effect

With this function you can turn on the Chorus effect and select the effect type.

1. ➤ Use *[FUNCTION]* ▲ or *[FUNCTION]* ▼ to change into the 'Chr TYPE' menu. The current setting appears on the display.
2. ➤ Use *[YES]* and *[NO]* or the jog dial to assign the desired parameter:
  - 'Chorus1'
  - 'Chorus2'
  - 'GM Chorus1'
  - 'GM Chorus2'
  - 'Flanger1'
  - 'Flanger2'
  - 'Rotary1'
  - 'Rotary2'
3. ➤ Press *[YES]* and *[NO]* simultaneously to load the standard value 'GM Chorus2'.

### 8.7.10 Chorus volume

With this function you can set the Chorus effects volume in a range from 0 to 127.

1. ➤ Use *[FUNCTION]* ▲ or *[FUNCTION]* ▼ to change into the 'ChrLev' menu. The current setting appears on the display.
2. ➤ Adjust the effects ratio with the buttons *[YES]* and *[NO]* or with the jog dial.
3. ➤ Press *[YES]* and *[NO]* simultaneously to reset the effects ratio to the standard value (depending on the selected voice).

### 8.7.11 MIDI receive channel

With this function you can determine on which channel the keyboard receives MIDI information from other devices.

1. ➤ Use *[FUNCTION]* ▲ or *[FUNCTION]* ▼ to change into the 'Midi In' menu. The current setting appears on the display.
2. ➤ Specify the desired MIDI receive channel using the buttons *[YES]* and *[NO]* or the jog dial.
3. ➤ Press *[YES]* and *[NO]* simultaneously to reset channel selection to the standard value 'ALL'.

### 8.7.12 MIDI send channel

With this function you can determine on which channel the keyboard sends MIDI information to other devices.

1. Use **[FUNCTION] ▲** or **[FUNCTION] ▼** to change into the 'Midi Out' menu. The current setting appears on the display.
2. Specify the desired MIDI send channel using **[YES]** and **[NO]** or the jog dial.
3. Press **[YES]** and **[NO]** simultaneously to reset channel selection to the standard value '001'.

### 8.7.13 Automatic shutdown

With this function you can specify whether and after what time the automatic shutdown of the keyboard is carried out.

1. Use **[FUNCTION] ▲** or **[FUNCTION] ▼** to change into the 'Power Off' menu. The current setting appears on the display.
2. Use the buttons **[YES]** and **[NO]** or the jog dial to assign one of the following options:
  - '030' (automatic shutdown after 30 minutes)
  - '060' (automatic shutdown after 60 minutes)
  - 'OFF' (automatic shutdown off).
3. Press **[YES]** and **[NO]** simultaneously to activate the presetting '030'.

## 8.8 Loading / saving user settings

1. Press **[BANK]**. The display shows the last selected memory bank.
2. Press **[BANK]** again and specify the desired memory bank 1 ... 8.
3. Hold down **[STORE]** and simultaneously press one of the **[M1]** to **[M4]** buttons. The current settings are then stored in the respective memory location (M1 to M6). Please note that any data previously stored there will be deleted.
4. Press one of the **[M1]** to **[M6]** buttons. The saved settings are then loaded from the corresponding memory and replace the current settings thereby.



*In O.T.S. mode, no settings can be loaded from the device memory.*

## 8.9 Resetting user settings

Proceed as follows to reset the user settings:

1. ▶ Turn off the keyboard.
2. ▶ When turning it back on again, keep *[STORE]* and *[M1]* pressed.  
⇒ All user settings will be reset without further confirmation prompt.

## 8.10 Deleting stored recordings

### Deleting all recordings

Proceed as follows to clear the recording memory:

1. ▶ Turn off the keyboard.
2. ▶ When turning it back on again, keep *[SONG]* and *[RECORD]* pressed.  
⇒ All recordings will be deleted without further confirmation prompt.

### Deleting certain tracks

Proceed as follows to delete certain tracks:

1. ▶ Hold down *[SHIFT]* and press *[RECORD]* to enable the recording mode.
2. ▶ Use *[YES]* and *[NO]* or the jog dial to select the track you want to delete (accompaniment track *[ACCOMP]* or melody tracks *[MELODY 1]* ... *[MELODY 5]*).
3. ▶ Confirm with *[YES]* or cancel the procedure with *[NO]*.  
⇒ All highlighted recordings will be deleted without further confirmation prompt.

## 9 Operating

### 9.1 Piano mode

Press *[PIANO]* to activate the Piano mode. The whole keyboard sounds with normal piano voice.

### 9.2 Transposing

With this function you can adjust the pitch of the claviature in 12 semitone steps up or down.

1. ▶ Hold down *[SHIFT]* and press one of the *[TRANSPOSE]* buttons.  
⇒ The display shows 'Transpos'.
2. ▶ Use the *[TRANSPOSE]* buttons or the jog dial to adjust the keyboard pitch.
3. ▶ Press simultaneously the *[TRANSPOSE]* buttons or *[YES]* and *[NO]* to restore the presetting (no transposing).

### 9.3 Playing demo sequences

The demo sequences stored in the device show the sound and the pitch range of the keyboard.

1. ▶ Press *[DEMO]* to start playing the demo sequences in a continuous loop.
2. ▶ Use *[YES]* and *[NO]* to toggle between the five demo sequences (see ↪ Chapter 13.4 'Demo list' on page 71).
3. ▶ Press *[DEMO]* again or *[START/STOP]* to stop playing the demo sequences.

## 9.4 Style playing

The styles stored in the keyboard are used to support your own playing at performances, while practising and recording.

### 1. ▶ Rhythm track playback

Press *[STYLE]* to activate the Style mode.

⇒ The display shows 'STYLE', the number and the name of the selected style.

2. ▶ Use *[YES]* and *[NO]*, the jog wheel or a direct select button to enable the desired style directly (see [Chapter 13.2 'Styles list' on page 57](#)).

3. ▶ Press *[START/STOP]* to start playback of the auto accompaniment rhythm track. Alternatively, press *[SYNC START]* to activate the synchronous start mode and then press a key on the keyboard to start playback of the rhythm track of the automatic accompaniment.

4. ▶ Press *[START/STOP]* to stop playback of the auto accompaniment rhythm track.

### 5. ▶ Playback of all accompaniment tracks

In Style mode, press *[CHORD MODE]* to activate chord recognition (see).

⇒ The display shows 'A.B.C.'. The keyboard is divided into two areas, the left area is the chord area.

6. ▶ Activate the synchronous start mode with *[SYNC START]*.

7. ▶ Press a key in the chord area.

⇒ The display shows 'FULL RANGE'. Chords to control the automatic accompaniment are recognized on the entire keyboard.

8. ▶ Press *[SYNC START]* and play a chord in the chord area of the keyboard.

⇒ The auto accompaniment starts for all accompaniment tracks.

9. ▶ Press *[START/STOP]* to start the auto accompaniment rhythm track first.

10. ▶ Play a chord in the chord area.

⇒ Playback of all accompaniment tracks of the selected style starts.

## 9.5 Playing songs

The keyboard offers a choice of 120 songs to accompany your playing at performances, while practising and recording. In addition, five tracks for your own recordings are available.

1. ▶ Press *[SONG]* to start playing the songs in a continuous loop.

2. ▶ Use *[YES]* and *[NO]* or the jog dial to toggle between the stored songs (see [Chapter 13.1 'Song list' on page 55](#)). If the selected file is empty, the display shows the message 'NoFile!' and the song playback will be stopped.

3. ▶ Press *[START/STOP]* to start or stop song playback.

4. ▶ Press *[STYLE]* or *[VOICE]* to exit the song mode.

## 9.6 Metronome

1. ▶ Press **[METRONOME]** to turn the Metronome on and off.
2. ▶ Set the desired tempo with the two function buttons **[TEMPO]** or the jog dial, see [Chapter 9.7 'Tempo' on page 32](#).
3. ▶ Set the desired time signature via the functions menu, see [Chapter 8.7.2 'Time signature' on page 23](#).



*The metronome is always synchronized with the currently playing style.*

## 9.7 Tempo

All preprogrammed songs, styles and voices, and the metronome function are stored with certain tempo information. These presets can be adjusted at any time.

1. ▶ Press the two function buttons **[TEMPO]** or turn the jog dial during playback or with running metronome to adjust the desired tempo in a range from '30' ... '280'.
2. ▶ Press the function buttons **[TEMPO]** simultaneously to reset the tempo to the respective standard value.

## 9.8 Mixer

This menu is used to adjust the volume of the various style elements.

1. ▶ Hold down **[SHIFT]** and press one of the two function buttons **[MIXER]** to open the Mixer menu. The display shows the last selected option, e.g. 'Rhythm\_s' and the last setting.
2. ▶ Use **[YES]** and **[NO]** or the jog dial to adjust the volume in a range from '0' ... '127'.



**3.** ▶ Hold down *[SHIFT]* and press repeatedly one of the two function buttons *[MIXER]* to call up and adjust the following options in succession:

- 'Rhythm\_s'
- 'Rhythm\_m'
- 'Bass'
- 'Chord1'
- 'Chord2'
- 'Chord3'
- 'Phrase1'
- 'Phrase2'
- 'Upper1'
- 'Upper2'
- 'LOWER'
- 'U-Disk'

## 9.9 Selecting voices

The keyboard features a selection of 600 authentic voices, see [Chapter 13.3 'Voice list'](#) on page 62.

- 1.** ▶ Press *[VOICE]* or one of the direct selection buttons to activate the last set or a desired voice directly.
  - ⇒ The display shows the name and number of the first right hand voice (main voice), e.g. 'VOICE R1', '001', 'GrandPno'.
- 2.** ▶ Use *[YES]* and *[NO]*, the jog dial or a direct select button to assign another voice.
  - Press the *[VOICE]* button repeatedly to toggle between the upper and lower voice of a direct selection button.

In dual and split mode, you toggle between the first and second right hand voice and the left hand voice by repeatedly pressing the *[VOICE]* button: 'VOICE R1', 'VOICE R2' and 'VOICE L', see the following chapters for Dual and Split mode.

## 9.10 Dual mode

In Dual mode, you can play two voices simultaneously.

- 1.** ▶ First, select the first voice as described in section [Chapter 9.9 'Selecting voices'](#) on page 33.
- 2.** ▶ Hold down *[SHIFT]* and press *[DUAL]* to switch to dual mode.
  - ⇒ The display shows the number and description of the second right hand voice, e.g. 'VOICE R2', '186', 'Strings'.

3. ➤ Use *[YES]* and *[NO]*, the jog dial or a direct select button to assign another voice.  
Press the *[VOICE]* button repeatedly to toggle between the upper and lower voice of a direct selection button.  
⇒ The currently set second voice appears in the display ('Voice R2'). If you now press a key, both voices sound simultaneously.
4. ➤ Hold down *[SHIFT]* and press *[DUAL]* again to exit the dual mode.



*When the keyboard is split, the Dual mode affects only the keys to the right of the keyboard split point.*

## 9.11 Split mode

With this function you can split the claviature into two areas and assign different voices. By default, the bass voice is left of the split point.

1. ➤ If desired, individually specify the split point as described at [Chapter 8.7.3 'Split point' on page 23](#).
2. ➤ Assign the right hand voice as described in section [Chapter 9.9 'Selecting voices' on page 33](#).
3. ➤ Hold down *[SHIFT]* and press *[LOWER]* to switch to split mode.
4. ➤ Use *[YES]* and *[NO]*, the jog dial or a direct select button to assign a voice for the area to the left of the split point (second voice).  
⇒ The currently set second voice appears in the display ('Voice L'). You now have the opportunity to play the keyboard with two different voices.
5. ➤ Press *[LOWER]* again to exit split mode.

## 9.12 TWINOVA

In TWINOVA mode, the keyboard is divided into two areas with the same voice and the same pitch.

1. ➤ Select the desired voice, see [Chapter 9.9 'Selecting voices' on page 33](#).
2. ➤ Hold down *[SHIFT]* and press *[TWINOVA]* to switch to TWINOVA mode.
3. ➤ If necessary, specify a split point, see [Chapter 8.7.3 'Split point' on page 23](#).
4. ➤ If necessary, adapt the Octave area. Hold down *[SHIFT]* and press *[OCTAVE]*.  
⇒ The display shows 'Octave'.

5. ▶ Use [YES] and [NO] or the jog dial to move the octave area by one octave up or down ('-01' ... '+01').  
Press [YES] and [NO] simultaneously to restore the standard setting '000'.
6. ▶ Hold down [SHIFT] and press [TWINOVA] again to exit the TWINOVA mode.

## 9.13 Harmony mode

In harmony mode, suitable tones (harmonized) are automatically added to the notes played to create polyphony.

1. ▶ Hold down [SHIFT] and press [HARMONY] to switch to harmony mode.
  - ⇒ The [HARMONY] symbol appears on the display and the last selected Harmony type is displayed, e.g. 'Duet'.
2. ▶ Select one of the following harmony settings as described in chapter [Chapter 8.7.5 'Selection Harmony setting'](#) on page 25:
  - 'Duet'
  - 'Standard Trio'
  - 'Full Chord'
  - 'Rock Duet'
  - 'Country Duet'
  - 'Country Trio'
  - 'Block'
  - '4 Close 1'
  - '4 Close 2'
  - '4 Open'
  - '1+5'
  - 'Octave1'
  - 'Octave2'
  - 'Strum'
  - 'Echo1'
  - 'Echo2'
  - 'Echo3'
  - 'Echo4'
  - 'Tremolo1'
  - 'Tremolo2'
  - 'Tremolo3'
  - 'Tremolo4'
  - 'Trill1'
  - 'Trill2'
  - 'Trill3'
  - 'Trill4'
3. ▶ Hold down [SHIFT] and press [HARMONY] again to exit the harmony mode.



*The Harmony settings Duet, Standard Trio, Full Chord, Rock Duet, Country Duet, Octave, Echo, Tremolo and Trill can be activated at any time. The other settings are only available when the chord recognition is turned on.*

## 9.14 Chord detection

By default, the 'Auto Bass Chord' (A.B.C.) is disabled. Press the button [CHORD MODE] to activate the function. The area to the left of the split point is already known as the chord area. When you now play a chord, both bass and chord voices will sound together.







*As the A.B.C. chord detection is based on the root note of the chord, some chords that could be played according to the chord dictionary can not be detected by A.B.C., such as B $\flat$ , B $\flat$ 6, B $\flat$ 6(9), B $\flat$ (9), B $\flat$ aug, B $\flat$ aug, B $\flat$ m6, Bm6, A $\dim$ 7, B $\flat$ dim7.*

**Single and multi-finger mode.**

If the chord is played on base of the illustration for multi-finger chords below, it will be detected as a 'multi-fingered' chord. If not, it will be detected as a 'single-finger' chord.

■ **Single-finger chords**

With this method, you can play chords with only one, two or three fingers within the capabilities of the auto accompaniment. Here we show you some examples of single finger chords (C, Cm, C7 and Cm7).

































<p><b>C</b></p> 	<p>• <b>To play a major chord</b> Press the root note of the chord</p>
<p><b>C<sub>m</sub></b></p> 	<p>• <b>To play a minor chord</b> Press the root note together with the nearest black key to the left of it .</p>
<p><b>C<sub>7</sub></b></p> 	<p>• <b>To play a seventh chord</b> Press the root note together with the nearest white key to the left of it .</p>
<p><b>C<sub>m7</sub></b></p> 	<p>• <b>To play a minor seventh chord</b> Press the root notes together with the nearest white and black keys to the left of it (three keys altogether) .</p>



*When the A.B.C. function is activated, press the keys to the left of the split point. The chords are detected as single-finger chords.*

■ **Multi-finger chords**

With this method, you can play chords with normal fingering within the capabilities of the auto accompaniment. Here we show you 32 chords using the example of C chords.

0 C 	1 C <sub>6</sub> 	2 C <sub>M7</sub> 	3 C <sub>M7</sub> (#11) 	4 C <sub>M</sub> (9) 	5 C <sub>M7</sub> (9) 
6 C <sub>6</sub> (9) 	7 C <sub>aug</sub> 	8 C <sub>m</sub> 	9 C <sub>m6</sub> 	10 C <sub>m7</sub> 	11 C <sub>m7</sub> (b5) 
12 C <sub>m</sub> (9) 	13 C <sub>m7</sub> (9) 	14 C <sub>m7</sub> (11) 	15 C <sub>m</sub> M <sub>7</sub> 	16 C <sub>m</sub> M <sub>7</sub> (9) 	17 C <sub>dim</sub> 
18 C <sub>dim7</sub> 	19 C <sub>7</sub> 	20 C <sub>7sus4</sub> 	21 C <sub>7</sub> (b5) 	22 C <sub>7</sub> (9) 	23 C <sub>7</sub> (#11) 
24 C <sub>7</sub> (b13) 	25 C <sub>7</sub> (b9) 	26 C <sub>7</sub> (13) 	27 C <sub>7</sub> (#9) 	28 C <sub>M7aug</sub> 	29 C <sub>7aug</sub> 
30 C <sub>sus4</sub> 	31 C <sub>1+2+5</sub> 	The notes in brackets are optional; the chords will also be recognised without them.			

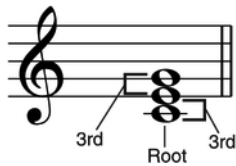

Major third – four half steps (semitones)

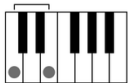

Minor third – three half steps (semitones)

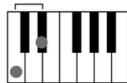

#### ■ Chord basics

A chord consists of three or more notes played together. The most commonly used chord is the triad consisting of three notes: Root, third and fifth of the corresponding scale. The C major chord for example is formed from the notes C (root), E (the third note of the C major scale), and G (the fifth note of the C major scale). In the C major chord shown, the lowest note is the root (this is the basic form of the chord - if you play other notes of the chord as the lowest note, this is called 'chord inversion'). The root is the central sound of the chord on which the other chord notes are built upon. The interval between adjacent notes and the root determines whether the result is a major or minor third.

#### ■ Chord structure

The lower interval in our triad (between root and third) determines whether the result is a major or minor triad. In addition, we can shift the highest note by a half step up or down to produce two additional chords.

The basic characteristic of the triad remains even if we change the order of the notes to create different inversions. Consecutive chords can be softly connected in a chord progression, e.g. by choosing suitable chord inversions (also called 'voicings').

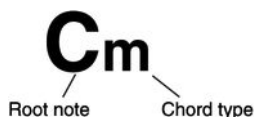

<p><b>Major chord</b></p> <p><b>C<sub>M</sub></b></p> <p>Minor 3rd    Major 3rd</p>	<p><b>Minor chord</b></p> <p><b>C<sub>m</sub></b></p> <p>Major 3rd    Minor 3rd</p>	<p><b>Augmented chord</b></p> <p><b>C<sub>aug</sub></b></p> <p>Major 3rd    Major 3rd</p>	<p><b>Diminished chord</b></p> <p><b>C<sub>dim</sub></b></p> <p>Minor 3rd    Minor 3rd</p>
---	---	---	--

- **Chord names**  
Chord names will tell you everything you need to know about a chord. Through the chord name, you know the root, whether it is a major, minor, or diminished chord, whether a large or flatted seventh is needed and what changes or tensions are used - all at a glance.

■ **Some chord types**

<p><b>Suspended 4<sup>th</sup></b></p> <p><b>C<sub>aus4</sub></b></p> <p>Perfect 5<sup>th</sup>    Perfect 4<sup>th</sup></p>	<p><b>7<sup>th</sup></b></p> <p><b>C<sub>7</sub></b></p> <p>Flatted 7<sup>th</sup>    Major chord</p>	<p><b>Minor 7<sup>th</sup></b></p> <p><b>C<sub>m7</sub></b></p> <p>Flatted 7<sup>th</sup>    Minor chord</p>	<p><b>Major 7<sup>th</sup></b></p> <p><b>C<sub>M7</sub></b></p> <p>Major 7<sup>th</sup>    Major chord</p>
<p><b>Minor/major 7<sup>th</sup></b></p> <p><b>C<sub>mM7</sub></b></p> <p>Major 7<sup>th</sup>    Minor chord</p>	<p><b>7<sup>th</sup>, flatted 5<sup>th</sup></b></p> <p><b>C<sub>7</sub><sup>(b5)</sup></b></p> <p>Flatted 5<sup>th</sup>    7<sup>th</sup> chord</p>	<p><b>Minor 7<sup>th</sup>, flatted 5<sup>th</sup></b></p> <p><b>C<sub>m7</sub><sup>(b5)</sup></b></p> <p>Flatted 5<sup>th</sup>    Minor 7<sup>th</sup> chord</p>	<p><b>7<sup>th</sup>, suspended 4<sup>th</sup></b></p> <p><b>C<sub>7sus4</sub></b></p> <p>Flatted 7<sup>th</sup>    Suspended 4<sup>th</sup> chord</p>

## 9.15 Chord dictionary

The Chord dictionary is basically a built-in 'Chord book' assisting you to find the right tones of a chord if you e.g. know only the chord name, but not how to play it.

**1.** ▶ **DICT 1 (chord learning mode)**

Hold down *[SHIFT]* and press *[DICT.]* to call up the 'DICT.1' mode. In this mode, the keys from C4 on are used to assign the chord type, and the keys from C6 to assign the root note. If you have pressed the keys for chord type and root note, the display shows the chord name and the individual notes in the notation system.

For example, If you want to play a Cm7 chord, press the C6 key (root note C in the Cm7 chord). You will hear no sound, but the root note is displayed.

Press the A4 key (chord type for minor-seventh chord, 'm7'). You will hear no sound, but the chord name and the notes you should play for the specified chord appear in the display.

**2.** ▶ **DICT 2 (chord testing mode)**

Hold down *[SHIFT]* and press *[DICT.]* again to call up the 'DICT.2' mode. The display shows a randomly generated chord name, but not its individual notes in the notation system. If you play the right chord within three seconds, the next randomly generated chord name appears. If this does not happen, the individual notes of the chord in the notation system appear automatically in the display.

In the chord dictionary, the 12 root notes and 24 chord types are presented as follows:

Key names	Root note	Key names	Root note
C6	C	F#6	F#/G <sub>b</sub>
C#6	C#/D <sub>b</sub>	G6	G
D6	D	A <sub>b</sub> 6	G#/A <sub>b</sub>
E <sub>b</sub> 6	D#/E <sub>b</sub> 6	A6	A
E6	E	B <sub>b</sub> 6	A#/B <sub>b</sub>
F6	F	B6	B

Key names	Chord type	Key names	Chord type
C4	M	C5	7 <sub>b</sub> 9
C#4	M(9)	C#5	7(9)
D4	6	D5	7(#9)
E <sub>b</sub> 4	mM7	E <sub>b</sub> 5	7 <sub>b</sub> 13
E4	M7	E5	7(13)
F4	m	F5	7(#11)
F#4	m(9)	F#5	dim7
G4	m6	G5	dim
A <sub>b</sub> 4	m7(9)	A <sub>b</sub> 5	7aug
A4	m7	A5	aug
B <sub>b</sub> 4	m7 <sub>b</sub> 5	B <sub>b</sub> 5	7sus4
B4	7	B5	sus4



## 9.16 Auto Accompaniment

### Auto accompaniment functions

The accompaniment function is controlled via four parameters: INTRO, MAIN (A, B), FILL (A, B) and ENDING.

#### 1. ► INTRO

To insert an intro, press *[INTRO/ENDING]* before beginning to play. Depending on the selected Style the rhythm starts with two to four bars, followed by the main part.

#### 2. ► MAIN (A, B)

The main part consists of an accompaniment pattern with different sections and is repeated until you enter a new song section (FILL or ENDING). The individual sections of the main part are selected via *[A]* and *[B]*.

#### 3. ► FILL (A, B)

Use *[A]* and *[B]* to insert two different fill bars. Each fill measure will be repeated until you release the button.

#### 4. ► ENDING

If you press *[INTRO/ENDING]* while Auto Accompaniment is activated, an ending part suitable for the Accompaniment is started, finishing the song.

### Playing with auto accompaniment

1. ► Select the desired style ().

2. ► Use *[CHORD MODE]* to enable chord recognition.

3. ► Use *[SYNC START]* to enable Sync Start operation.

4. ► Press *[INTRO/ENDING]* to start the song with an Intro.

⇒ The character 'A' is flashing on the display.

5. ► The accompaniment starts as soon as you press a key in the chord area.

6. ► If desired, you can use *[FILL B]* to insert fill measures as transition into main part B.

⇒ The character 'B' is flashing on the display.

7. ► Press *[INTRO/ENDING]* again to conclude the song with an Ending.

## 9.17 Accompaniment track volume, muting

This function allows you to adjust the volume of the accompaniment track to the volume of the claviature or to mute the accompaniment track.

#### 1. ► Setting the accompaniment track volume

Hold down *[SHIFT]*.

Use *[ACCOMP]* to adjust the accompaniment track volume in a range from 0 ... 127.

## 2. ▶ **Muting the accompaniment track**

Hold down *[SHIFT]*.

Press the two function buttons *[ACCOMP]* simultaneously to mute the accompaniment track. The display shows 'OFF'.

## 3. ▶ **Re-enabling the accompaniment track**

Hold down *[SHIFT]* and press the two function buttons *[ACCOMP]* to re-enable the accompaniment track.

⇒ The display returns to the set volume level of the accompaniment track, e.g. '100'.

## 9.18 Fade in, Fade out

With this function you can increase the volume of the accompaniment track gradually to the preset volume of the selected Style (Fade in) and decrease it again at the end of the piece (Fade Out).

### 1. ▶ Hold down *[SHIFT]* and press *[FADE]* before starting the Style.

⇒ The volume of the Style is raised within ten seconds from zero to the preset value.

### 2. ▶ Hold down *[SHIFT]* and press *[FADE]* at the end of the piece.

⇒ The volume of the Style is lowered within ten seconds to zero.

## 9.19 One Touch Setting

One Touch Setting (O.T.S. or one-key operation) is a convenient function that allows you to immediately reconfigure all settings with just one single key press. This is about rhythm-based compilations of keyboard voices. With this function, four parameter types (M1 to M4) can be loaded.

### 1. ▶ Press *[O.T.S.]* to activate the function. The display shows 'OTS'. Press one of the keys *[M1]* to *[M4]*, then the keyboard loads the corresponding parameter types that match the current Style. Chord recognition will automatically be switched on.

### 2. ▶ Press one of the *[M1]* to *[M4]* buttons to load one of the available presets.

### 3. ▶ Press the *[O.T.S.]* button again to deactivate O.T.S. mode.

### 4. ▶ The default parameters stored in O.T.S. are:

- Track on / off
- Change voice R1, R2, L
- Volume R1, R2, L
- Chorus level voice R1, R2, L
- Reverb level voice R1, R2, L

## 9.20 Performance Assistant

The 'Performance Assistant' is a playing aid, which allows you to simulate different keyboards on the claviature.

1. ➤ Press *[PERFORM]* to activate the playing aid.  
GUITAR mode is enabled by default. Use the jog dial to select a file.
2. ➤ Adjust the Tempo using the *[TEMPO]* buttons.
3. ➤ Adjust the time signature with *[YES]* and *[NO]*.

### 9.20.1 GUITAR mode

In this mode, you can simulate a guitar sound on the claviature. The table shows the various play areas.

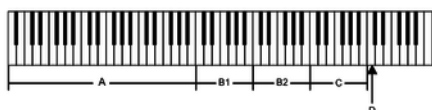

#### Chord area A

This area includes the keys A0 to B3 of the claviature.

The chord type appears in the display. The root of the guitar chord sounds.

#### Area B1

This area includes the white keys C4 to B4 of the claviature.

Once the chord type is displayed, you can play several figures of broken chords with the white keys in this area. While playing, you also have the possibility to vary the chord played in the chord area.

#### Area B2

This area includes the white keys C5 to A6 of the claviature.

Once the chord type is displayed, you can play a solo track with the white keys in this area. While playing, you also have the possibility to vary the chord played in the chord area.

#### Rhythm area C

This area includes the white keys C6 to G6 of the claviature.

Once the chord type is displayed, you can play a rhythm track with the white keys in this area. While playing, you also have the possibility to vary the chord played in the chord area.

#### Shift D

Key C7. Press this button to shift upwards.

## 9.20.2 PIANO mode

After enabling the playing aid, use the jog dial to change to the PIANO mode.

In this mode, the entire claviature sounds with the piano voice. The table shows the various play areas.



Play basic chords in area A and an accompanying melody in areas B and C an.

Keys A6, B6 and C7 give you the opportunity to complete a phrase with a suitable ending.

## 9.21 Practising songs

The keyboard offers 120 practising songs, where you can mute the right hand voice and play this part yourself.

### 1. ▶ Playing and stopping practising songs

Press [SONG] to enter the playback mode for practising songs. 'SONG' appears on the display and all practising songs are being played in an endless loop.

Press [START/STOP] to stop the currently playing practising song. This will not quit the mode for practising song playback 'SONG'.

### 2. ▶ Single loop

If you press [START/STOP] again the current song is repeated in an endless loop until you press [START/STOP] again.

### 3. ▶ Selecting a practising song

Use the jog dial or [YES] and [NO] to select the desired practising song. If you select a new practising song, the display shows first the title in running text, then the abbreviation.

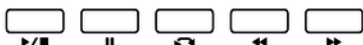

### 4. ▶ Playback control

Pre-count

An Intro of different length will be played before playback begins. The bar display starts with a negative value. The practising song starts with bar 1.

Fast-forward, rewind, pause

Hold down ►► during playback to fast-forward the practising song. Use ◀◀ to rewind bar by bar. Press ■ to pause playback and again ■ to continue the playback at the same position. Press [START/STOP] to start the practising song from the beginning.

Repeat function

While the practising song is playing you can set two loop marks with ⇄. Press the button at the desired start point of the loop and again at the end point.

### 5. ▶ To exit practising song playback press any direct select or function button.

**Lesson mode**

When practising, it is mainly important to play the right **notes** at the right **time**. In this mode you can check your progress. Press *[LESSON]* in SONG mode to activate the Lesson mode. There are three training stages. Use *[R]* and *[L]* to specify which hand you want to practise. If you don't select a hand, the right hand will automatically be selected.

**Lesson 1 - playing in time**

Press *[LESSON]* to enter the Lesson mode. 'LESSON 1' appears on the display. In this mode, it is only rated whether you play the notes at the right time, but not whether you hit the right notes.

1. ▶ Press *[START/STOP]* to start practising.
2. ▶ If you have selected 'R' the right hand voice is muted and you have to play the right hand yourself. As long as you are in time, you will hear the right hand voice. If you have selected 'L' the left hand voice is muted and you have to play the left hand yourself. As long as you are in time, you will hear the left hand voice. Are both 'L' and 'R' selected the voices for both hands are muted. You then have to play in time with both hands.
3. ▶ After completing the exercise, you will learn the result.

**Lesson 2 - hitting the right notes**

Press *[LESSON]* again to enter the Lesson mode 2. 'LESSON 2' appears on the display. In this mode, it is only rated whether you hit the right notes, but not whether you play them at the right time. The practising song continues only when you play the right note.

1. ▶ Press *[START/STOP]* to start practising.
2. ▶ After completing the exercise, you will learn the result.

**Lesson 3 - hitting the right notes at the right time.**

Press *[LESSON]* again to enter the Lesson mode 3. 'LESSON 3' appears on the display. In this mode, it is rated whether you play the right notes at the right time. The practising song continues only when both is correct.

1. ▶ Press *[START/STOP]* to start practising.
2. ▶ After completing the exercise, you will learn the result.

**9.22 Recording function**

You can record your own songs with the keyboard and save up to five recordings as user songs in the internal memory. Unsaved recordings are retained in the clipboard memory after switching the keyboard off.

The recording are stored in the memory register 121 – 125.

## 9.22.1 Recording preparation

Before starting the recording, you have to select a user song for saving the recording.

1. ➤ Hold down [SHIFT] and press [RECORD] to enable the recording mode.
  - ⇒ The display shows the standard name of the first user song 'RecSong1' and the sequence number.
2. ➤ Press [YES] and [NO] or turn the jog dial to select a user song you want to record.
3. ➤ Hold down [SHIFT] and press [RECORD] again to record-enable the keyboard.
  - ⇒ The 'REC' icon appears on the display.
4. ➤ The recording starts as soon as you play the first tone or chord or press [START/STOP].

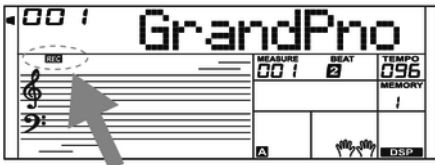

If you select the accompaniment track and A.B.C. (see [Chapter 9.14 'Chord detection' on page 36](#)) is open, play an effective chord in the left area. Press [CHORD MODE] again with open A.B.C. to enable the chord recognition for the entire keyboard or press [START/STOP] to start recording.

### 9.22.1.1 Setting accompaniment/metronome, voice, tempo and tracks

1. ➤ If desired, select an accompaniment/metronome or voice and set the recording tempo.
2. ➤ Keep [SHIFT] pressed and press [ACCOMP] (accompaniment track) or [MELODY1] ... [MELODY5] (melody tracks) to set the desired recording track. Preset is 'Melody1'.



You have the option to record the accompaniment track along with a melody track. If you want to record with accompaniment function or a style, select again the desired chord recognition after setting the recording mode.

If you want to use a metronome for recording, enable previously the metronome and set the desired tempo.

## 9.22.2 Recording

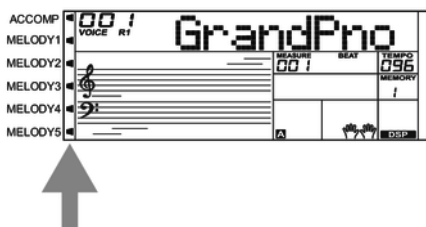

1. ➤ The availability of the tracks is indicated by the icons on the left edge of the display:
  - Icon flashing: selected track, existing data can always be overwritten.
  - Icon lights permanently: Track contains data and can play along to the recording.
  - Icon off: Track contains no data and cannot be played.

2. ➤ Use the corresponding buttons to select the track [ACCOMP] or [MELODY1] ... [MELODY5].



During recording the device selects automatically the next empty track next to the data containing track. If all tracks contain data, select 'Melody 1' to save your recording.

### 9.22.3 Stopping recording

To stop recording, hold down [SHIFT] and press [RECORD]. The display shows 'Wait... ' (depending on the length of the recording) until the recording is saved.

When the full memory capacity has been reached, the recording is terminated automatically and the recorded data is saved. While storing, the indicator flashes quickly. The display shows 'Rec\_Full'.

After saving the device plays the recording in endless loop. Press [START/STOP] to stop recording.

### 9.22.4 Playing a recording

Use [SONG] to change to normal playback mode and select the recording for playback ( ➤ Chapter 9.5 'Playing songs' on page 31).

### 9.22.5 Delete recording

#### Deleting certain tracks

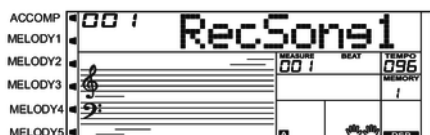

1. ➤ Hold down [SHIFT] and press [RECORD].
2. ➤ Use the jog dial to select one of the five user songs from which you want to delete one or more tracks.
3. ➤ Hold down [SHIFT] and press [RECORD] again.
  - ⇒ The 'REC' icon appears on the display.
4. ➤ Hold down [SHIFT] and keep [RECORD] pressed for two seconds.
  - ⇒ The display shows 'Delete?'.

- 5.** ▶ Release *[SHIFT]* and *[RECORD]*. Keep *[SHIFT]* pressed and press *[ACCOMP]* (accompaniment track) or *[MELODY1]* ... *[MELODY5]* (melody tracks) to select the desired recording track you want to keep.

The icons on the left edge of the display indicate which tracks should be kept or deleted:

- Icon on: Track will be deleted.
- Icon off: Track will be kept.

- 6.** ▶ Confirm with *[YES]* to delete the track.

⇒ All data on the selected track will be deleted.

- 7.** ▶ To cancel the process press *[NO]*.

⇒ The device returns to state Recording preparation without deleting data.

### Deletes all user songs

First switch off the device to delete all user songs.

- ▶ Hold down *[RECORD]* and *[SONG]* and switch on the device.

⇒ All user songs will be deleted without further confirmation prompt.

## 9.23 MIDI function

MIDI stands for 'Musical Instrument Digital Interface' and represents the standard interface between a computer and electronic instruments.

You can exchange MIDI data with other MIDI devices via the MIDI and USB interfaces of the keyboard.



*The exchange of MIDI data via the USB interface is only possible with WIN 32-bit systems.*

## 9.24 USB storage medium

The keyboard supports USB flash drives with a capacity from 16 MB to 32 GB that are formatted using the FAT 16/32 file system.

Connect a suitable USB stick with the keyboard and press *[USB DEVICE]* to enter the USB menu. If the stick could be correctly initialized the display shows 'Play'. If an error occurs the display shows 'DiskErr!'.



*In Memory mode, the 'MMKD' folder is automatically created for all user data.*

*On MIDI playback, you can adjust the volume using *[MIXER]* and *[YES]/[NO]*.*



### 9.24.1 USB stick playback

1. ➤ Connect the USB stick with the keyboard and open the USB menu.  
Use the jog dial to highlight the 'Play' option.
2. ➤ Confirm with [YES].  
⇒ The display shows the available directories.
3. ➤ Use the jog dial to highlight the desired directory and confirm for opening with [YES].
4. ➤ Use the jog dial to highlight the desired MIDI file and start or stop playback with [START/STOP].

### 9.24.2 Loading data from USB stick

1. ➤ Connect the USB stick with the keyboard and open the USB menu.  
Use the jog dial to highlight the 'Load' option.
2. ➤ Confirm with [YES].  
⇒ The display shows the available options: Loading a song ('LoadSong'), loading a style ('LoadSty') and loading user settings ('LoadMem').
3. ➤ Use the jog dial to highlight the desired option and confirm with [YES].
4. ➤ Use the jog dial to highlight the song, style or user setting to be loaded and start the procedure with [YES].
5. ➤ You can cancel the process at any time with [NO].

### 9.24.3 Save data to USB stick

1. ➤ Connect the USB stick with the keyboard and open the USB menu.  
Use the jog dial to highlight the 'Save' option.
2. ➤ Confirm with [YES].  
⇒ The display shows the available options: Saving a song ('SaveSong'), saving a style ('SaveSty') and saving user settings ('SaveMem').
3. ➤ Use the jog dial to highlight the desired option and confirm with [YES].
4. ➤ Use the jog dial to highlight the desired file (i.e. user song) and confirm with [YES].
5. ➤ Use the keyboard of the device to enter a file name and confirm again with [YES].
6. ➤ You can cancel the process at any time with [NO].

## 9.24.4 Deleting all data on a USB stick

1. ▶ Connect the USB stick with the keyboard and open the USB menu.  
Use the jog dial to highlight the 'Delete' option.
2. ▶ Confirm with [YES].  
⇒ The display shows the available options: Deleting a song ('UserSong'), deleting a style ('UserSty') and deleting user settings ('UserMem').
3. ▶ Use the jog dial to highlight the desired option and confirm with [YES].
4. ▶ Use the jog dial to highlight the desired file and confirm with [YES].
5. ▶ Confirm the confirmation prompt with [YES] to delete the data.
6. ▶ You can cancel the process at any time with [NO].

## 9.25 Reset to factory defaults

Proceed as follows to restore the factory default settings:

1. ▶ Turn off the keyboard.
2. ▶ When turning it back on again, keep the buttons [YES] and [NO] pressed.  
⇒ All user songs and settings are reset or deleted without further confirmation prompt. The display shows 'Loading!'.

If you only want to delete the stored user settings but want to keep your own recordings in the memory, proceed as follows:

1. ▶ Turn off the keyboard.
2. ▶ When turning it back on again, keep [STORE] and [M1] pressed.  
⇒ All user settings will be deleted without further confirmation prompt.

If you only want to delete your own recordings but want to keep your changed user settings in the memory, proceed as follows:

1. ▶ Turn off the keyboard.
2. ▶ When turning it back on again, keep [SONG] and [RECORD] pressed.  
⇒ All recordings will be deleted without further confirmation prompt.

## 10 Technical specifications

Input connections	Power supply	Connector for power adapter
	USB port	USB type B
	MIDI port	DIN socket, 5-pin
	AUX in	1/4" jack socket
	Microphone	1/4" jack socket
	Pedal box	1/4" jack socket
Output connections	MIDI port	DIN plug, 5-pin
	AUX out	1/4" jack socket
Display	Multi-functional LCD	
Keyboard	88 weighted keys with hammer action Touch sensitivity adjustable in four steps (off, soft, normal, hard)	
Tonal colours	Number	600
	Polyphony	128-voice
	Layer	Left, right 1, right 2
	Functions	Split, duo (Twinova)
Styles	Number	230
	Control	[START/STOP], [SYNC START], [INTRO/ENDING], [MAIN A], [MAIN B], [FILL IN A], [FILL IN B], [A.B.C.], [FADE IN], [FADE OUT], [ACCOMP VOLUME]
	O.T.S.	built-in
	Chord types	32
Effects	DSP	on / off
	Master EQ	6 presettings
	Reverb	10 types, 128 levels
	Chorus	8 types, 128 levels
Accompaniment function	built-in	
Harmony mode	26 types	
Pitch adjustment	Transposing	-12 ... +12
	Octave transposing	-1 ... +1
	Voices	-50 ... +50
Functions	Mixer	12 tracks
	Memory for user settings	8 banks, each with 6 memory locations

## Technical specifications

	Pedal support	Sustain
	Pitch bend wheel	built-in
	Metronome	0, 2 ... 9
	Tempo	30 ... 280
	Chord dictionary	built-in
Pedals	Sustain	
Demo and practice songs	Practising songs	120
	Sequencer	5 user songs (5 melody tracks, 1 accompaniment track)
	Demo pieces	5
Amp	2 × 10 W	
Speaker	2 × 10 W	
	2 × 20 W	
Power supply	Power adapter (12 V $\overline{=}$ / 2000 mA, centre positive)	
Dimensions (W × H × D)	1365 mm × 137 mm × 366 mm	
Weight	13.8 kg	
Colour	Black	
Ambient conditions	Temperature range	0 °C...40 °C
	Relative humidity	50 %, non-condensing

### Further information

Design	Black
Surface	Matt
Wooden keyboard	No
Ivory-feel keyboard	No
Auto Accompaniment	Yes
Number of rhythms	230
Polyphony	128
Sounds	600
Storage medium	USB MIDI

## 11 Plug and connection assignment

### Introduction

This chapter will help you select the right cables and plugs to connect your valuable equipment in such a way that a perfect sound experience is ensured.

Please note these advices, because especially in 'Sound & Light' caution is indicated: Even if a plug fits into the socket, an incorrect connection may result in a destroyed power amp, a short circuit or 'just' in poor transmission quality!

### Balanced and unbalanced transmission

Unbalanced transmission is mainly used in semi-professional environment and in hifi use. Instrument cables with two conductors (one core plus shielding) are typical representatives of the unbalanced transmission. One conductor is ground and shielding while the signal is transmitted through the core.

Unbalanced transmission is susceptible to electromagnetic interference, especially at low levels, such as microphone signals and when using long cables.

In a professional environment, therefore, the balanced transmission is preferred, because this enables an undisturbed transmission of signals over long distances. In addition to the conductors 'Ground' and 'Signal', in a balanced transmission a second core is added. This also transfers the signal, but phase-shifted by 180°.

Since the interference affects both cores equally, by subtracting the phase-shifted signals, the interfering signal is completely neutralized. The result is a pure signal without any noise interference.

### 1/4" TS phone plug (mono, unbalanced)

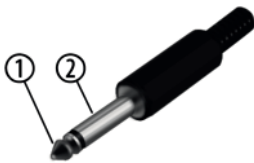

1	Signal
2	Ground, shielding

### 1/4" TRS phone plug (mono, balanced)



1	Signal (in phase, +)
2	Signal (out of phase, -)
3	Ground

## 12 Troubleshooting

In the following we list a few common problems that may occur during operation. We give you some suggestions for easy troubleshooting:

Symptom	Remedy
No sound when playing the keyboard.	Check the position of the volume control. Check if headphone output 2 has a headphone connected. Check the mixer's volume setting R1 / R2 / L.
Noise when using a mobile phone.	Do not place the turned on mobile phone on the keyboard. Keep a sufficient distance from the keyboard when using a mobile phone.
Auto accompaniment does not start with sync start.	The automatic start-up of the auto accompaniment along with sync start function only works when you play a piano key in the left hand area.
Harmony mode can not be activated.	Check whether a drum kit is assigned to the R1 voice. In this case, the harmony mode can not be activated.
Keyboard is not detected by the software when connected to a computer.	Check the USB cable for correct connection. Connect the USB cable to another USB port on the computer.

If the procedures recommended above do not succeed, please contact our Service Center. You can find the contact information at [www.thomann.de](http://www.thomann.de).

## 13 Appendix

### 13.1 Song list

No.	Name	Display	No.	Name	Display
<b>FOLK &amp; COUNTRY</b>			027	La Donne Mobile	DoneMble
001	Toccata	Toccata	028	Serenata	Serenata
002	Carry Me Back To Old Virginy	Virginy	029	Bridal March	Bridal
003	El Condor Pasa	ElCondor	030	Can't Help Fallin' In Love	InLove
004	Traumerei	Traumere	031	Chanson Du Toreador	Toreador
005	Aloha Oe	AlohaOe	032	Danny Boy	DannyBoy
006	Greensleeves	Sleeves	033	Ich Liebe Dich	LieDich
007	Home Sweet Home	SwetHome	034	Wiegenlied 2	Wieglied2
008	Heidenroslein	Heidenro	035	Spanish Serenade	Serenade
009	Long Long Ago	LongAgo	036	Piano Concerto	Concerto
010	Die Lorelei	Lorelei	037	Piano Concerto 2	Concrto2
011	Over The Waves	OverWave	038	Madame Butterfly	Madame
012	My Darling Clementine	Clemtine	039	Invitation To The Dance	ToDance
013	Gwine To Run All Night	Gwine	040	Wiegenlied 3	Wieglied3
014	Symphony No.6 "Pathetic"	Sympony6	041	Jingle Bells	JingBell
015	Oh! Susanna	Susanna	042	Joy To The World	JoyWorld
016	Prelude Op.28 No.15	Prelude	043	La Paloma	LaPaloma
017	The House Of The Rising Sun	RiseSun	044	My Bonnie	MyBonnie
018	Menuet	Menuet	045	La Reine De Saba	Saba
<b>GOLDEN &amp; POP</b>			046	La Cucaracha	Cucarach
019	Vaslse Des Fleurs	Fleurs	047	Little Brown Jug	BrownJug
020	Fruhlingsstimmen	Fruhling	048	Battle Hymn Of The Republic	BatlHyme
021	Frohlicher Landmann	Landmann	049	Yellow Rose Of Texas	YellRose
022	Are You Lonesome Tonight?	Lonesome	050	The Wabash Cannon Ball	CannBall
023	Toy Symphony	ToySymph	051	Annie Laurie	AnnieLa
024	Auld Lang Syne	LangSyne	052	Turkish March	Turkish
025	Ave Maria	AveMaria	053	An Die Musik	Musik
026	Tales Of Hoffman	Hoffman	054	Lieder Ohne Worte Op.62 No.6	Lieder

No.	Name	Display	No.	Name	Display
055	Red River Valley	RedRiver	082	Pizzicato Polka	Polka
056	Die Forelle	Forelle	083	Menuett	Menuett
057	Symphony No. 94 "Suprise"	No. 94	084	Rigoletto	Rigoletto
058	Polonaise	Polonais	085	Serenade	Serenade
059	Rondeau	Rondeau	086	Song Without Words	SOngNoWd
060	Moments Musicaux	Musicaux	087	Swan	Swan
061	Silent Night	SlTNight	088	The Dying Swan	DyingSwn
062	Moldau	Moldau	089	Swan Lake Valse	SwnWalse
063	Summertime	Summer	090	The Happy Farmer	HpFarmer
064	Dreaming Of Home And Mother	Dreaming	091	The Sleeping Beauty	SleepBty
065	Ring Ring De Banjo	DeBanjo	092	La Traviata	LaTravia
066	Der Lindenbaum	DerLinde	093	Wiegenlied	Wiegenli
067	Zigeunerweisen	Zigeuner	094	Mov. 2 Adagio Non Troppo Piano Sonata No. 9 In D	Sonata9
068	The Maiden's Prayer	Prayer	095	Piano Sonata No. 11 In A	Sonata11
069	Fur Elise	FurElise	096	Prelude In C	Prelude
070	Der Freischutz	DerFreis	097	Chinese Dance	ChDance
071	Maria! Maria!	Maria!	098	Emperor Waltz	Emperor
<b>CLASSICAL</b>			099	March Militaire	Militair
072	Waves Of The Danube	Danube	100	Symphony No. 40	Symphony
073	Santa Lucia	SantaLuc	<b>PIANO</b>		
074	Solveig's Song	Solveig	101	Hanon Piano Fingering 1	Hanon1
075	Piano Sonatan No. 8 In C Minor (Pathetique)	Patheque	102	Hanon Piano Fingering 2	Hanon2
076	Brahms Waltz	BrmsWltz	103	Hanon Piano Fingering 3	Hanon3
077	Aida	Aida	104	Hanon Piano Fingering 4	Hanon4
078	Carmen-Prelude	Carmen	105	Hanon Piano Fingering 5	Hanon5
079	L'Arlesienne	L'Arlesi	106	Basic Tutorial Beyer Piano 12	Beyer12
080	Ungarische Tanz	Uungaris	107	Basic Tutorial Beyer Piano 13	Beyer13
081	Mazurka	Mazurka	108	Basic Tutorial Beyer Piano 14	Beyer14



No.	Name	Display	No.	Name	Display
109	Basic Tutorial Beyer Piano 15	Beyer15	115	Basic Tutorial Beyer Piano 45	Beyer45
110	Basic Tutorial Beyer Piano 18	Beyer18	116	Christmas Eve	XmasEve
111	Cuckoo	Cuckoo	117	Basic Tutorial Beyer Piano 50	Beyer50
112	Basic Tutorial Beyer Piano 21	Beyer21	118	Basic Tutorial Beyer Piano 52	Beyer52
113	Basic Tutorial Beyer Piano 29	Beyer29	119	Basic Tutorial Beyer Piano 55	Beyer55
114	Butterfly	Buterfly	120	Basic Tutorial Beyer Piano 59	Beyer59

## 13.2 Styles list

No.	Name	Display	No.	Name	Display
<b>8BEAT</b>			021	Pop 16Beat 4	Pop16Bt4
001	8Beat Ballad	8BtBld	022	Modern 16Beat	Modr16Bt
002	8Beat Piano	8BtPiano	023	16Beat Hot	16BtHot
003	8Beat 1	8Beat1	024	16Beat Modern	16BtModr
004	Guitar Pop 1	GtPop1	025	16Beat Funk 3	16BtFuk3
005	8Beat Hip Hop	8BtHiHop	026	16Beat 3	16Beat3
006	8Beat Blues Rock	8BtBluRk	027	Cool Beat	CoolBeat
007	8Beat 2	8Beat2	028	16Beat Ballad 2	16BtBld2
008	Sweet Beat	SweetBt	029	16Beat 4	16Beat4
009	8Beat 3	8Beat3	030	Pop Shuffle	PopShfl
010	Rhythm&Beat 2	Rhy&Bt2	<b>POP &amp; BALLAD</b>		
<b>16BEAT</b>			031	Pop Rock 1	PopRock1
011	16Beat 1	16Beat1	032	Pop Dance 1	PopDanc1
012	16Beat Funk 1	16BtFuk1	033	Pop Fusion	PopFusn
013	16Beat Ballad 1	16BtBld1	034	Analog Night 1	AnalgNt1
014	16Beat R&B	16BtR&B	035	6/8 Pop	6/8Pop
015	Pop 16Beat 1	Pop16Bt1	036	Brit. Pop 1	BritPop1
016	16Beat Funk 2	16BtFuk2	037	Brit. Pop 2	BritPop2
017	16Beat Dance	16BtDanc	038	Pop Hit	PopHit
018	Pop 16Beat 2	Pop16Bt2	039	Fusion Shuffle	FusShufl
019	16Beat 2	16Beat2	040	Analog Night 2	AnalgNt2
020	Pop 16Beat 3	Pop16Bt3	041	Guitar Pop 3	GtPop3

No.	Name	Display	No.	Name	Display
042	Pop Beat	PopBeat	071	New Shuffle	NewShufl
043	Soft Beat	SoftBeat	072	Rock Hip Hop	RkHipHop
044	60's Pop	60'sPop	073	Rock&Roll 1	R'N'R1
045	Sting Latin	StigLatn	074	Rock Shuffle	RockShfl
046	R&B Ballad 1	R&BBld1	075	Rock&Roll 2	R'N'R1
047	Guitar Ballad	GtBallad	<b>BALLROOM</b>		
048	Ballad Rock	BaldRock	076	Tango 1	Tango1
049	Piano Pop	PianoPop	077	Spain Matador	Matador
050	Soft Ballad	SoftBald	078	Twist 1	Twist1
051	Natural Ballad	NatulBld	079	Twist 2	Twist2
052	Love Ballad	LoveBald	080	Big Band Fox	BandFox
053	Easy Ballad	EasyBald	081	Tango 2	Tango2
054	Miami Folk	MiamiBld	082	Slow Fox	SlowFox
055	Slow Ballad	SlowBald	083	Slow Waltz 1	SlowWlz1
056	Folk Ballad	FolkBald	084	Swing Fox	SwingFox
057	Pop Ballad 1	PopBald1	085	Salsa 1	Salsa1
058	Pop Ballad 2	PopBald2	086	Cha Cha 1	ChaCha1
059	EP Ballad	EPBallad	087	Cha Cha 2	ChaCha2
060	New R&B Ballad	NewRBBld	088	Beguine 1	Beguine1
<b>ROCK</b>			089	Beguine 2	Beguine2
061	Rock	Rock	090	Rumba 1	Rumba1
062	New Wave	NewWave	091	Samba 1	Samba1
063	Ska	Ska	092	Samba 2	Samba2
064	Pop Rock 2	PopRock2	093	Jive	Jive
065	Slow Rock	SlowRock	094	Fox Trot	FoxTrot
066	70's Rock&Roll	70'sRock	<b>DANCE</b>		
067	Folk Rock	FolkRock	095	Techno 1	Techno1
068	Soft Rock	SoftRock	096	Hip Hop 1	HipHop1
069	Old Rock	OldRock	097	House 1	House1
070	Easy Rock	EasyRock	098	Down Beat	DownBeat

No.	Name	Display	No.	Name	Display
099	Progressive	Progress	128	Swing	Swing
100	Rap 1	Rap1	129	Latin Jazz 2	LatinJz2
101	Disco	Disco	130	Fusion	Fusion
102	70's Disco	70'sDisc	131	Acid Jazz	AcidJazz
103	Club Dance	ClubDanc	132	Cool Jazz Ballad	CoolJzBd
104	Euro Dance	EuroDanc	133	Swing Shuffle	SwingSfl
105	Garage	Garage	134	Big Band Medium	BandMid
<b>SOUL &amp; FUNK</b>			135	Ragtime	Ragtime
106	Funk 1	Funk1	<b>COUNTRY</b>		
107	Classic Funk	ClasFunk	136	Country Pop 1	CntyPop1
108	Jay R&B	JayR&B	137	Bluegrass 1	Blugras1
109	Gospel Swing	GopSwing	138	8Beat Country	8BtCnty
110	Gospel	Gospel	139	Modern Country	ModrCnty
111	Funk 2	Funk2	140	Country Pop 2	CntyPop2
112	Electric Funk	ElecFunk	141	Bluegrass 2	Blugras2
113	Groove Funk	GrooveFk	142	2/4 Country	2/4Cnry
114	Rubber Funk	RubberFk	143	Country Quick Steps	QuickStp
115	Cool Funky	ColFunky	144	Country Folk	CntyFolk
116	Jazz Funk	JazzFunk	145	Country Shuffle	CnyShufl
117	Groove	Groove	<b>LATIN &amp; LATIN DANCE</b>		
118	Soul	Soul	146	Samba 3	Samba3
119	Hip Hop Soul	HipHopSl	147	Bossa Nova	BosaNova
120	Hip Hop Beat	HipHopBt	148	Latin	Latin
121	R&B	R&B	149	New Reggae	NewRegga
122	British Soul Pop	BritSoul	150	Reggae Dance	DanRegga
123	Latin Jazz 1	LatinJz1	151	Paso Doble	Pasodobl
124	Big Band 1	BigBand1	152	Lite Bossa	LteBossa
125	Dixieland 1	Dixland1	153	Latin Rock	LatinRck
126	Guitar Swing 1	GtSwing1	154	Beguine 3	Beguine3
127	Broadway Big Band	BwayBand	155	Slow Bolero	SlBolero

No.	Name	Display	No.	Name	Display
156	Disco Samba	DscSamba	184	Sirtake	Sirtake
157	Mambo	Mambo	185	Dangdut	Dangdut
158	Meneito	Meneito	186	6/8 Flipper	6/8Flipp
159	Rumba 2	Rumba2	187	New Age	NewAge
160	Rumba 3	Rumba3	188	Tarantella	Tarantel
161	Lambada	Lambada	189	Scottish	Scottish
162	Pop Cha Cha 1	PChaCha1	190	Norteno	Norteno
<b>WALTZ &amp; TRADITIONAL</b>			<b>PIANIST</b>		
163	Waltz	Waltz	191	Pianist 1	Pianist1
164	Old Waltz	OldWaltz	192	Pianist 2	Pianist2
165	English Waltz	EngWaltz	193	Pianist 3	Pianist3
166	German Waltz	GemWaltz	194	March 1	March1
167	Italian Mazurka	ItaMazuk	195	Italian Polka	ItaPolka
168	Waltz	MexWaltz	196	Slow Waltz	SlwWltz
169	Vienna Waltz	VinaWltz	197	Waltz 1	Waltz1
170	Slow Waltz 2	SlwWltz2	198	Waltz 2	Waltz2
171	Jazz Waltz	JazzWltz	199	Waltz 3	Waltz3
172	Polka	Polka	200	Vienna Waltz	VinaWtz
173	6/8 March	6/8March	201	Latin	Latin
174	German Polka	GemPolka	202	Tango	Tango
175	Party Polka	PtyPolka	203	Lambada	Lambada
176	Army March	ArmMarch	204	Samba	Samba
177	March	March	205	ChaCha	ChaCha
178	US March	USMarch	206	Beguine	Beguine
179	French Musette	FMusette	207	Salsa	Salsa
180	Mazurka	Mazurka	208	Pop Bossa	PopBossa
<b>WORLD</b>			209	Jazz 1	Jazz1
181	Enka Ballad	EnkaBald	210	Jazz 2	Jazz2
182	Laendler	Laendler	211	Jazz 3	Jazz3
183	Hawaiian	Hawaiian	212	Jazz 4	Jazz4

No.	Name	Display	No.	Name	Display
213	Jazz 5	Jazz5	222	Pop 1	Pop1
214	Jazz 6	Jazz6	223	Pop 2	Pop2
215	Jazz 7	Jazz7	224	Pop 3	Pop3
216	Boogie	Boogie	225	Pop 4	Pop4
217	Jive	Jive	226	Ballad 1	Ballad1
218	Dixland	Dixland	227	Ballad 2	Ballad2
219	Blues 1	Blues1	228	Ballad 3	Ballad3
220	Blues 2	Blues2	229	Ballad 4	Ballad4
221	Jazz Blues	JazBlues	230	6/8 Ballad 2	6/8Bld2

## 13.3 Voice list

No.	Name	Display	No.	Name	Display
<b>PIANO</b>			031	Detuned Electric Piano 2	DetunEP2
001	Acoustic Grand Piano	GrandPno	032	Electric Piano	E.Piano
002	Acoustic Grand Piano 2	GrandPn2	033	Electric Piano 2	E.Piano2
003	Acoustic Grand Piano 3	GrandPn3	034	Electric Piano 3	E.Piano3
004	Acoustic Grand Piano (wide)	GrandPnW	035	Electric Piano 4	E.Piano4
005	Acoustic Grand Piano (dark)	GrandPnD	036	Electric Piano 1 (velocity mix)	E.PnoV1
006	Bright Acoustic Piano	BritePno	037	Electric Piano 2 (velocity mix)	E.PnoV2
007	Bright Acoustic Piano 2	BritePn2	038	60's Electric Piano	60'sEP
008	Bright Acoustic Piano 3	BritePn3	039	EP legend	EPLegend
009	Bright Acoustic Piano (wide)	BritePnW	040	Phase EP	PhaseEP
010	Electric Grand Piano	E.Grand	041	Clavi	Clavi
011	Electric Grand Piano 2	E.Grand2	042	Clavi 2	Clavi2
012	Electric Grand Piano (wide)	E.GrandW	043	Phase Clavi	PhaseClv
013	Electric Grand Piano (dark)	E.GrandD	044	Wah Clavi	WahClv
014	Honky Tonk Piano	HnkyTonk	045	Pulse Clavi	PulseClv
015	Honky Tonk Piano 2	HnyTonk2	046	Dream EP	DreamEP
016	Honky Tonk Piano (wide)	HnyTonkW	047	Tremolo EP	TremoEP
017	Honky Tonk Piano (dark)	HnyTonkD	048	Funk EP	FunkEP
018	Harpsichord	Harpsi	049	Warm EP	WarmEP
019	Harpsichord 2	Harpsi2	050	Choir EP	ChoirEP
020	Harpsichord (octave mix)	HarpsiO	051	Wah EP	WahEP
021	Harpsichord (wide)	HarpsiW	052	Modern EP	ModernEP
022	Harpsichord (with key off)	HarpsiOf	053	EP Pad	EPPad
023	Octave Grand Piano	OctPno	054	Celesta	Celesta
024	Octave Grand Piano 2	OctPno2	055	Celesta 2	Celesta2
025	Piano & Strings	Pno&Str	056	Celesta 3	Celesta3
026	Piano & Pad	Pno&Pad	057	Glockenspiel	Glocken
027	Piano & Choir	Pno&Cho	058	Glockenspiel 2	Glocken2
028	Piano & EP	Pno&EP	059	Music Box	MusicBox
029	Piano & Vibraphone	Pno&Vib	060	Music Box 2	MusicBox2
030	Detuned Electric Piano	DetunEP	061	Music Box 3	MusicBox3

No.	Name	Display	No.	Name	Display
062	Vibraphone	Vibra	093	Church Organ 3	ChurOrg3
063	Vibraphone 2	Vibra2	094	Church Organ (octave mix)	ChurOrgO
064	Vibraphone (wide)	VibraW	095	Detuned Church Organ	DeChuOrg
065	Marimba	Marimba	096	Reed Organ	ReedOrgn
066	Marimba 2	Marimba2	097	Reed Organ 2	ReedOrg2
067	Marimba (wide)	MarimbaW	098	Rotary Organ	RotyOrgn
068	Xylophone	Xylophon	099	Puff Organ	PuffOrgn
069	Xylophone 2	Xylopho2	100	Accordion	Acordion
070	Xylophone 3	Xylopho3	101	Accordion 2	Acordin2
071	Tubular Bells	TubulBel	102	Accordion 3	Acordin3
072	Tubular Bells 2 Church Bell	TubulBe2	103	Harmonica	Harmnica
073	Church Bell	ChurBell	104	Harmonica 2	Harmnic2
074	Carillon	Carillon	105	Harmonica 3	Harmnic3
075	Dulcimer	Dulcimer	106	Tango Accordion	TangoAcd
076	Dulcimer 2	Dulcime2	107	Tango Accordion 2	TangAcd2
077	Santur	Santur	<b>GUITAR</b>		
<b>ORGAN</b>			108	Acoustic Guitar (nylon)	NylonGtr
078	Italian 60's Organ	60'sOrgn	109	Acoustic Guitar (nylon) 2	NylonGt2
079	Drawbar Organ	DrawOrgn	110	Acoustic Guitar (nylon) 3	NylonGt3
080	Drawbar Organ 2	DrawOrg2	111	Acoustic Guitar (nylon + key off)	NylGtrOf
081	Detuned Drawbar Organ	DeDraOrg	112	Ukulele	Ukulele
082	Drawbar Organ 3	DrawOrg3	113	Acoustic Guitar (steel)	SteelGtr
083	Detuned Percussive Organ	DePerOrg	114	Acoustic Guitar (steel) 2	SteelGt2
084	Percussive Organ	PercOrgn	115	12-Strings Guitar	12StrGtr
085	Percussive Organ 2	PercOrg2	116	Mandolin	Mandolin
086	70's Percussive Organ	70'sPcOr	117	Mandolin 2	Mandoli2
087	Percussive Organ 3	PercOrg3	118	Steel Guitar with Body Sound	SteelBdy
088	Rock Organ	RockOrgn	119	Electric Guitar (jazz)	JazzGtr
089	Rock Organ 2	RockOrg2	120	Electric Guitar (jazz) 2	JazzGtr2
090	Rock Organ 3	RockOrg3	121	Electric Guitar (pedal steel)	PedalGtr
091	Church Organ	ChurOrgn	122	Electric Guitar (clean)	CleanGtr
092	Church Organ 2	ChurOrg2	123	Electric Guitar (clean) 2	CleanGt2

No.	Name	Display	No.	Name	Display
124	Electric Guitar (detuned clean)	DetClnGt	155	Synth Bass	SynBass
125	Mid Tone Guitar	MidTonGt	156	Synth Bass 2	SynBass2
126	Electric Guitar (muted)	MutedGtr	157	Synth Bass 3	SynBass3
127	Electric Guitar (muted) 2	MutedGt2	158	Synth Bass 4	SynBass4
128	Electric Guitar (funky cutting)	FunkGt	159	Warm Synth Bass	WarmBass
129	Electric Guitar (muted velo-sw)	MutVelGt	160	Resonance SynBass	ResoBass
130	Jazz Man	JazzMan	161	Clavi Bass	ClavBass
131	Overdriven Guitar	Ovrdrive	162	Hammer	Hammer
132	Overdriven Guitar 2	Ovrdriv2	163	Attack Bass	AtackBas
133	Guitar Pinch	GtPinch	164	Synth Bass (rubber)	RubbBass
134	Distortion Guitar	DistGtr	165	Synth Bass (rubber) 2	RubbBas2
135	Distortion Guitar 2	DistGtr2	166	Attack Pulse	AtackPls
136	Distortion Guitar (with feedback)	FeedbkGt	<b>STRINGS &amp; ORCHESTRAL</b>		
137	Guitar Feedback	GtrFedbk	167	Violin	Violin
138	Distorted Rhythm Guitar	DistRyth	168	Violin 2	Violin2
139	Guitar Harmonics	GtrHarmo	169	Violin (slow attack)	SlViolin
140	Guitar Harmonics 2	GtHarmo2	170	Viola	Viola
141	Velocity Nylon Guitar	NylnGtVe	171	Viola 2	Viola2
<b>BASS</b>			172	Cello	Cello
142	Acoustic Bass	AcoBass	173	Cello 2	Cello2
143	Acoustic Bass 2	AcoBass2	174	Contrabass	Contrabs
144	Wah Bass	WahBass	175	Contrabass 2	Contrbs2
145	Electric Bass (finger)	FngrBass	176	Tremolo Strings	TremStr
146	Finger Slap Bass	FngrSlap	177	Tremolo Strings 2	TremStr2
147	Electric Bass (pick)	PickBass	178	Tremolo Strings 3	TremStr3
148	Electric Bass (pick) 2	PickBas2	179	Pizzicato Strings	PizzStr
149	Fretless Bass	Fretless	180	Pizzicato Strings 2	PizzStr2
150	Fretless Bass 2	Fretles2	181	Orchestral Harp	Harp
151	Slap Bass	SlapBass	182	Orchestral Harp 2	Harp2
152	Slap Bass 2	SlapBas2	183	Yang Chin	YangChin
153	Slap Bass 3	SlapBas3	184	Timpani	Timpani
154	Slap Bass 4	SlapBas4	185	Timpani 2	Timpani2



No.	Name	Display	No.	Name	Display
186	String Ensembles	Strings	217	Bright Trombone	BritBone
187	String Ensembles 2	Strings2	218	Tuba	Tuba
188	String Ensembles 3	Strings3	219	Tuba 2	Tuba2
189	String Ensembles 4	Strings4	220	Muted Trumpet	MuteTrp
190	Strings & Brass	Str&Bras	221	Muted Trumpet 2	MuteTrp2
191	60's Strings	60'sStr	222	Muted Trumpet 3	MuteTrp3
192	Synth Strings	SynStrs	223	French Horn	FrHorn
193	Synth Strings 2	SynStrs2	224	French Horn 2	FrHorn2
194	Synth Strings 3	SynStrs3	225	French Horn 3	FrHorn3
195	Synth Strings4	SynStrs4	226	Brass Section	Brass
196	Synth Strings5	SynStrs5	227	Brass Section 2	Brass2
197	Choir Aahs	ChoirAah	228	Brass Section 3	Brass3
198	Choir Aahs 2	ChorAah2	229	Synth Brass	SynBrass
199	Choir Aahs 3	ChorAah3	230	Synth Brass 2	SynBras2
200	Voice Oohs	VoiceOoh	231	Synth Brass 3	SynBras3
201	Voice Oohs 2	VoicOoh2	232	Synth Brass 4	SynBras4
202	Humming	Humming	233	Synth Brass 5	SynBras5
203	Analog Voice	AnlVoice	234	Synth Brass 6	SynBras6
204	Synth Voice	SynVoice	235	Synth Brass 7	SynBras7
205	Synth Voice 2	SynVoic2	236	Synth Brass 8	SynBras8
206	Orchestra Hit	OrchHit	237	Analog Synth Brass	AnaBrass
207	Orchestra Hit 2	OrchHit2	238	Analog Synth Brass 2	AnaBras2
208	Bass Hit Plus	BassHit	239	Analog Synth Brass 3	AnaBras3
209	6th Hit	6thHit	240	Jump Brass	JumpBras
210	Euro Hit	EuroHit	241	Jump Brass 2	JumpBrs2
<b>BRASS</b>			242	Funny	Funny
211	Trumpet	Trumpet	243	Funny 2	Funny2
212	Trumpet 2	Trumpet2	<b>BRASS</b>		
213	Dark Trumpet	DarkTrp	244	Soprano Sax	SprnoSax
214	Trombone	Trombone	245	Soprano Sax 2	SprnSax2
215	Trombone 2	Trmbone2	246	Soprano Sax 3	SprnSax3
216	Trombone 3	Trmbone3	247	Alto Sax	AltoSax

No.	Name	Display	No.	Name	Display
248	Alto Sax 2	AltoSax2	279	Flute 3	Flute3
249	Alto Sax 3	AltoSax3	280	2 Flutes	2Flutes
250	Tenor Sax	TenorSax	281	Recorder	Recorder
251	Tenor Sax 2	TenoSax2	282	Recorder 2	Recorder2
252	Tenor Sax 3	TenoSax3	283	2 Recorders	2Records
253	Baritone Sax	BariSax	284	Pan Flute	PanFlute
254	Baritone Sax 2	BariSax2	285	Pan Flute 2	PanFlut2
255	Baritone Sax 3	BariSax3	286	Sweet Pan Flute	SwPanFlu
256	Oboe	Oboe	287	Blown Bottle	Bottle
257	Oboe 2	Oboe2	288	Blown Bottle 2	Bottle2
258	Oboe 3	Oboe3	289	Shakuhachi	Shakhchi
259	2 Oboes	2Oboes	290	Shakuhachi 2	Shakhch2
260	English Horn	EngHorn	291	Whistle	Whistle
261	English Horn 2	EngHorn2	292	Whistle 2	Whistle2
262	English Horn 3	EngHorn3	293	Ocarina	Ocarina
263	2 English Horns	2EngHons	294	Ocarina 2	Ocarina2
264	Bassoon	Bassoon	<b>SYNTH LEAD</b>		
265	Bassoon 2	Bassoon2	295	Lead 1 (square)	SquareLd
266	Bassoon 3	Bassoon3	296	Lead 1a (square) 2	SquarLd2
267	2 Bassoons	2Bassoons	297	Lead 1 (square) 3	SquarLd3
268	Clarinet	Clarinet	298	Lead 1b (sine)	SineLead
269	Clarinet 2	Clarine2	299	Lead 2 (sawtooth)	SawLead
270	Clarinet 3	Clarine3	300	Lead 2a (sawtooth) 2	SawLead2
271	2 Clarinets	2Clarinis	301	Lead 2 (sawtooth) 3	SawLead3
<b>PIPE</b>			302	Lead 2b (saw + pulse)	SawPlsLd
272	Piccolo	Piccolo	303	Lead 2c (double sawtooth)	DubSawLd
273	Piccolo 2	Piccolo2	304	Lead 2d (sequenced analog)	SquAnaLd
274	Piccolo 3	Piccolo3	305	Lead 2d (sequenced analog) 2	SqAnaLd2
275	2 Piccolos	2Picolos	306	Wavy Sawtooth	WavySaw
276	Sweet Flute	SweeFlut	307	Bauble Lead	BaubleLd
277	Flute	Flute	308	Super Analog	SuperAna
278	Flute 2	Flute2	309	Lead 3 (calliope)	CaliopLd

No.	Name	Display	No.	Name	Display
310	Lead 3 (calliope) 2	CalipLd2	342	Fifth Lead	FifLead
311	Lead 4 (chiff)	ChiffLd	343	Corrie	Corrie
312	Lead 4 (chiff) 2	ChiffLd2	344	Quint	Quint
313	Lead 4 (chiff) 3	ChiffLd3	<b>SYNTH PAD</b>		
314	Lead 5 (charang)	CharanLd	345	Pad 1 (new age)	NewAge
315	Lead 5 (charang) 2	CharaLd2	346	Pad 1 (new age) 2	NewAge2
316	Lead 5 (charang) 3	CharaLd3	347	Pad 2 (warm)	WarmPad
317	Lead 5 (charang) 4	CharaLd4	348	Pad 2 (warm) 2	WarmPad2
318	Lead 5a (wire lead)	WireLead	349	Pad 2a (sine pad)	SinePad
319	Lead 5a (wire lead) 2	WireLd2	350	Pad 3 (polysynth)	PolySyn
320	Lead 6 (voice)	VoiceLd	351	Pad 3 (polysynth) 2	PolySyn2
321	Lead 6 (voice) 2	VoiceLd2	352	Pad 3 (polysynth) 3	PolySyn3
322	Lead 7 (fifths)	FifthsLd	353	Pad 3 (polysynth) 4	PolySyn4
323	Lead 7 (fifths) 2	FifthLd2	354	Pad 4 (choir)	ChoirPad
324	Lead 8 (bass + lead)	BassLead	355	Pad 4 (choir) 2	ChoirPd2
325	Lead 8 (bass + lead) 2	BasLead2	356	Pad 4a (itopia)	ItopiaPd
326	Lead 8 (bass + lead) 3	BasLead3	357	Pad 5 (bowed)	BowedPad
327	Lead 8a (soft wrl)	SftWrlLd	358	Pad 5 (bowed) 2	BowedPd2
328	Massiness	Massin	359	Pad 6 (metallic)	MetalPad
329	Square	Square	360	Pad 6 (metallic) 2	MetalPd2
330	Slow Square Lead	SlwSquLd	361	Pad 7 (halo)	HaloPad
331	Sine Solo	SineSolo	362	Pad 7 (halo) 2	HaloPad2
332	Square Lead 4	SquarLd4	363	Pad 8 (sweep)	SweepPad
333	Thick Square	ThickSqu	364	Pad 8 (sweep) 2	SweepPd2
334	2Oscillators Lead	2OscLd	365	Pad 8 (sweep) 3	SweepPd3
335	Wavy Sawtooth 2	WavySaw2	366	Pan Pad	PanPad
336	Analog Lead	AnaLead	367	Pan Pad 2	PanPad2
337	Big Lead	BigLead	368	Dipolar Pad	DipolPad
338	Fat Lead	FatLead	369	PWM Pad	PWMPad
339	PWM 4th	Rezz4th	370	Warmly Pad	WarmlyPd
340	Delayed Lead	DelyLead	371	Horn Pad	HornPad
341	Delayed Lead 2	DlyLead2	372	Click Pad	ClickPad

No.	Name	Display	No.	Name	Display
373	Analog Pad	AnalogPd	404	FX 7b (echo pan)	EchoPan
374	80's Poly Pad	80'sPoly	405	FX 7a (echo bell)	EchoBell
375	PWM 4th Soft	Rezz4thS	406	FX 7a (echo bell) 2	EchoBel2
376	Synth Calliope Soft	CalioLdS	407	FX 7a (echo bell) 3	EchoBel3
377	Soft Vox	SoftVox	408	FX 8 (sci-fi)	Sci-Fi
378	5th SawWave	5thSaw	409	FX 8 (sci-fi) 2	Sci-Fi2
379	5th Lead Soft	FiftLdSf	<b>ETHNIC MISC.</b>		
380	Slow Square	SISquare	410	Sitar	Sitar
381	New Year Pad	NewYear	411	Sitar 2	Sitar2
382	Space Voice	SpcVoice	412	Banjo	Banjo
383	Rising	Rising	413	Banjo 2	Banjo2
384	Congregate	Congrega	414	Shamisen	Shamisen
<b>SYNTH SFX</b>			415	Shamisen 2	Shamise2
385	FX 1 (rain)	FXRain	416	Koto	Koto
386	FX 1 (rain) 2	FXRain2	417	Koto 2	Koto2
387	FX 2 (soundtrack)	Soundtrk	418	Taisho Koto	TaishoKt
388	FX 2 (soundtrack) 2	Sondtrk2	419	Kalimba	Kalimba
389	Prelude	Prelude	420	Kalimba 2	Kalimba2
390	FX 3 (crystal)	Crystal	421	Bag Pipe	BagPipe
391	FX 3 (crystal) 2	Crystal2	422	Bag Pipe 2	BagPipe2
392	FX 3a (synth mallet)	SynMalet	423	Fiddle	Fiddle
393	FX 4 (atmosphere)	Atmosphr	424	Fiddle 2	Fiddle2
394	FX 4 (atmosphere) 2	Atmosph2	425	Fiddle 3	Fiddle3
395	Warm Air	WarmAir	426	Shanai	Shanai
396	FX 5 (brightness)	Bright	427	Shanai 2	Shanai2
397	Smog	Smog	<b>PERCUSSIVE</b>		
398	FX 6 (goblins)	Goblins	428	Tinkle Bell	TnklBell
399	FX 6 (goblins) 2	Goblins2	429	Agogo	Agogo
400	Choir Bell	ChorBell	430	Steel Drums	SteelDrum
401	Choir Bell 2	ChorBel2	431	Woodblock	WoodBlok
402	FX 7 (echoes)	Echoes	432	Castanets	Castanet
403	FX 7 (echoes) 2	Echoes2	433	Taiko Drum	TaikoDrum

No.	Name	Display	No.	Name	Display
434	Concert Bass Drum	ConBasDm	466	Analog Low Conga	AnLoCnga
435	Acoustic Bass Drum	BassDrum	467	High Timbale	HiTimbal
436	Jazz Kick	JazzKick	468	Low Timbale	LoTimbal
437	Side Stick	SidStick	469	Cabasa	Cabasa
438	Analog Rim Shot	AnRiShot	470	Maracas	Maracas
439	Acoustic Snare	A.Snare	471	Analog Maracas	AnMaracas
440	Jazz Snare	JazSnare	472	Short Guiro	ShGuiro
441	Brush Tap	BrushTap	473	Long Guiro	LoGuiro
442	Concert SD	ConcetSD	474	Claves	Claves
443	Hand Clap	HandClap	475	Mute Cuica	MuCuica
444	Tom	Tom	476	Open Cuica	OpCuica
445	Brush Tom	BrushTom	477	Mute Triangle	MuTrgle
446	Closed Hi-hat	ClosedHH	478	Open Triangle	OpTrgle
447	Analog Closed Hi-hat	AnCloHH	479	Shaker	Shaker
448	Pedal Hi-hat	PedalHH	480	Mute Surdo	MuSurdo
449	Open Hi-hat	OpenHH	481	Open Surdo	OpSurdo
450	Crash Cymbal	CrashCym	482	Melodic Tom	MeloTom
451	Analog Cymbal	AnaCym	483	Melodic Tom 2	MeloTom2
452	Ride Cymbal	RideCym	484	Synth Drum	SynDrum
453	China Cymbal	ChinaCym	485	Rhythm Box Tom	RhythBox
454	Ride Bell	RideBell	486	Electric Drum	ElecDrum
455	Tambourine	Tambouri	487	Reverse Cymbal	RevCymbL
456	Splash Cymbal	SplashCy	<b>SFX</b>		
457	Cowbell	Cowbell	488	Guitar Fret Noise	FretNoiz
458	Analog Cowbell	AnaCowbl	489	Guitar Cutting Noise	GtCtNoiz
459	High Bongo	HiBongo	490	Acoustic Bass String Slap	BsStSlap
460	Low Bongo	LoBongo	491	Breath Noise	BrthNoiz
461	Mute Hi Conga	MuHiCnga	492	Flute Key Click	FlKeyClk
462	Open Hi Conga	OpHiCnga	493	Seashore	Seashore
463	Low Conga	LowConga	494	Rain	Rain
464	Analog Hi Conga	AnHiCnga	495	Thunder	Thunder
465	Analog Mid Conga	AnMiCnga	496	Wind	Wind

No.	Name	Display	No.	Name	Display
497	Stream	Stream	<b>COMBINED VOICE</b>		
498	Bubble	Bubble	529	Stereo Piano & Strings Pad	Pn&StrPd
499	Bird Tweet	Tweet	530	Stereo Piano & Choir	Pn&Choir
500	Bird Tweet 2	Tweet2	531	Stereo Piano & Synth Strings	Pn&SyStr
501	Dog	Dog	532	Stereo Piano & Warm Pad	Pn&WrmPd
502	Horse Gallop	HouseGlp	533	Stereo Piano & Soft EP	Pn&SfEP
503	Telephone Ring	Telephone	534	FM Electric Piano	FMEP
504	Telephone Ring 2	Telphon2	535	Digital Piano	DigitlPn
505	Door Creaking	DoorCrek	536	E.Piano & Strings	EP&Str
506	Door	Door	537	Piano & Acoustic Guitar	EP&Str
507	Scratch	Scratch	538	E.Piano & Vibraphone	EP&Vibra
508	Wind Chime	WindChim	539	E.Piano 2 & Pad	EP2&Pad
509	Helicopter	Helicptr	540	E.Piano 2 & Strings	EP2&Str
510	Car Engine	CarEngin	541	Harpsichord & Stereo Strings	Hrps&Str
511	Car Stop	CarStop	542	Music Box & Stereo Strings	MBox&Str
512	Car Pass	CarPass	543	Vibraphone & Stereo Strings	Vib&Str
513	Car Crash	CarCrash	544	Vibraphone Octave	VibraOct
514	Siren	Siren	545	Vibraphone & Marimba & Kalimba	Vib&M&K
515	Train	Train	546	Marimba & Kalimba	Mar&Kal
516	Jetplane	Jetplane	547	Marimba Delay	MarDelay
517	Starship	Starship	578	Xylophone Octave	XylopOct
518	Burst Noise	BurtNois	549	Organ & Stereo Strings	Orgn&Str
519	Applause	Applause	550	Stereo Organ & Piano	Orgn&Pno
520	Laughing	Laughing	551	Rock Organ & Strings	RkOr&Str
521	Screaming	Scream	552	Church Organ & Choir	ChOr&Cho
522	Punch	Punch	553	Church Organ & Strings	ChOr&Str
523	Heart Beat	HeartBet	554	Acoustic Guitar & Flute	Gtr&Flut
524	Footsteps	Footstep	555	Acoustic Guitar & Clavi	Gtr&Clav
525	Gunshot	Gunshot	556	24 String Guitar	24StrGtr
526	Machine Gun	MachnGun	557	Steel Guitar & Warm Pad	StGt&Pad
527	Lasergun	Lasergun	558	Stereo Strings & Horn	Str&Horn
528	Explosion	Explosio	559	Orchestra	Orchestr

No.	Name	Display	No.	Name	Display
560	Full Strings	FullStr	581	Flute Octave	FluteOct
561	Full Strings 2	FullStr2	582	Flute & Oboe Octave	Fl&ObOct
562	Symphonic	Symphon	583	Flute & Clarinet Octave	Fl&ClOct
563	Stereo Choir & Strings	Cho&Str	584	Oboe & Bassoon	Oboe&Bn
564	Stereo Choir & Steel Guitar	Cho&Gtr	585	Oboe & Clarinet	Ob&Cl
565	3 Trumpet Loose	3Trumpet	586	Oboe & Clarinet & Bassoon	Ob&Cl&Bn
566	Trombone & Stereo Strings	Tomb&Str	587	Oboe Octave	OboeOct
567	3 Trombones Loose	3Trmbone	588	Oboe & Clarinet Octave	Ob&ClOct
568	3 Muted Trumpets Loose	3MuTrump	589	Oboe & Bassoon Octave	Ob&BnOct
569	Club Brass	ClubBras	590	Clarinet & Bassoon	Cl&Bn
570	Brass & Woodwinds	Brs&Wood	591	Clarinet & Oboe Octave	Cl&ObOct
571	Woodwinds & Strings	Wood&Str	<b>CHINESE INSTRUMENTS</b>		
572	Section Woods Small	WoodSmal	592	Standard Set	StandSet
573	Pan Flute & Strings Pad	PnFl&Str	593	Room Set	RoomSet
574	Koto & Shamisen	Kto&Sham	594	Power Set	PowerSet
575	Flute & Clarinet	Flu&Clar	595	Electronic Set	ElectSet
576	Flute & Oboe	Flu&Oboe	596	Analog Set	AnalgSet
577	Flute & Bassoon	Flu&Bn	597	Jazz Set	JazzSet
578	Flute & Oboe & Clarinet	Fl&Ob&Cl	598	Brush Set	BrushSet
579	Flute & Clarinet & Bassoon	Fl&Cl&Bn	599	Orchestra Set	OrcheSet
580	Flute & Oboe & Bassoon	Fl&Ob&Bn	600	SFX Set	SFXSet

### 13.4 Demo list

No.	Name	Display
001	Demo1	Demo1
002	Demo2	Demo2
003	Bossa Nova	BosaNova
004	Fusion	Fusion
005	Jazz	Jazz

### 13.5 MIDI implementation chart

Function		Sent	Received	Notes
Basic Channel	Default	1	ALL	
	Changed	1-16	1-16	
Mode	Default	No	Mode 3	
	Messages	No	Mode 3	
	Altered	*****	No	
Note Number	Note	0 – 127	0 – 127	
	True voice	*****	0 – 127	
Velocity Note	Note ON	Yes, 9nH, v = 1 – 127	Yes, 9nH, v = 1 – 127	
	Note OFF	No, 9nH, v = 0	Yes, 9nH, v = 0 or 8nH, v = 0 – 127	
After Touch	Keys	No	No	
	Channels	No	No	
Pitch Bend		Yes	Yes	
Control Change	0	Yes	Yes	Bank Select
	1	No	Yes	Modulation
	5	No	Yes	Portamento Time
	6	Yes	Yes	Data Entry
	7	Yes	Yes	Volume
	10	No	Yes	Pan
	11	No	Yes	Expression
	64	Yes	Yes	Sustain Pedal
	65	No	Yes	Portamento ON/OFF
	66	Yes	Yes	Sostenuto Pedal
	67	Yes	Yes	Soft Pedal
	80	No	Yes	Reverb Program
	81	No	Yes	Chorus Program
	91	Yes	Yes	Reverb Level
	93	Yes	Yes	Chorus Level
	120	No	Yes	All Sound Off
121	No	Yes	Reset All Controllers	
123	No	Yes	All Notes Off	



Function		Sent	Received	Notes
Program Change	True #	Yes *****	Yes 0 – 127	
System Exclusive		No	Yes	
System Common	Song Position Pointer	No	No	
	Song Select	No	No	
	Tune Request	No	No	
System Real Time	Clock	Yes	No	
	Commands	No *1	No *1	
Aux Messages	Local ON/OFF	No	No	
	Active Sensing	No	Yes	
	System Reset	No	No	

**MIDI channel modes**

	POLY	MONO
OMNI ON	Mode 1	Mode 2
OMNI OFF	Mode 3	Mode 4

## 14 Protecting the environment

### Disposal of the packaging material



For the transport and protective packaging, environmentally friendly materials have been chosen that can be supplied to normal recycling.

Ensure that plastic bags, packaging, etc. are properly disposed of.

Do not just dispose of these materials with your normal household waste, but make sure that they are collected for recycling. Please follow the notes and markings on the packaging.

### Disposal of your old device



This product is subject to the European Waste Electrical and Electronic Equipment Directive (WEEE) in its currently valid version. Do not dispose with your normal household waste.

Dispose of this device through an approved waste disposal firm or through your local waste facility. When discarding the device, comply with the rules and regulations that apply in your country. If in doubt, consult your local waste disposal facility.



