

ALLEN & HEATH



 **XONE:43**

USER GUIDE

Publication AP9968_1

Limited One Year Manufacturer's Warranty

Allen & Heath warrants the Allen & Heath - branded hardware product and accessories contained in the original packaging ("**Allen & Heath Product**") against defects in materials and workmanship when used in accordance with Allen & Heath's user manuals, technical specifications and other Allen & Heath product published guidelines for a period of ONE (1) YEAR from the date of original purchase by the end-user purchaser ("**Warranty Period**").

This warranty does not apply to any non-Allen & Heath branded hardware products or any software, even if packaged or sold with Allen & Heath hardware.

Please refer to the licensing agreement accompanying the software for details of your rights with respect to the use of software ("EULA").

Details of the EULA, warranty policy and other useful information can be found on the Allen & Heath website: www.allen-heath.com/legal.

Repair or replacement under the terms of the warranty does not provide right to extension or renewal of the warranty period. Repair or direct replacement of the product under the terms of this warranty may be fulfilled with functionally equivalent service exchange units.

This warranty is not transferable. This warranty will be the purchaser's sole and exclusive remedy and neither Allen & Heath nor its approved service centres shall be liable for any incidental or consequential damages or breach of any express or implied warranty of this product.

Conditions of Warranty

The equipment has not been subject to misuse either intended or accidental, neglect, or alteration other than as described in the User Guide or Service Manual, or approved by Allen & Heath.

Any necessary adjustment, alteration or repair has been carried out by an authorised Allen & Heath distributor or agent.

The defective unit is to be returned carriage prepaid to the place of purchase, an authorised Allen & Heath distributor or agent with proof of purchase. Please discuss this with the distributor or the agent before shipping. If the unit is to be repaired in a different country to that of its purchase the repair may take longer than normal, whilst the warranty is confirmed and parts are sourced. Units returned should be packed in the original carton to avoid transit damage.

DISCLAIMER: Allen & Heath shall not be liable for the loss of any saved/stored data in products that are either repaired or replaced.

Check with your Allen & Heath distributor or agent for any additional warranty information which may apply. If further assistance is required please contact Allen & Heath Ltd.



Xone:43 complies with the European Electromagnetic Compatibility directives 2004/108/EC and the European Low Voltage directives 2006/95/EC.

Any changes or modifications to the equipment not approved by Allen & Heath could void the compliance of the product and therefore the users authority to operate it.

XONE:43 User Guide AP9968 Issue 1

Copyright © 2015 Allen & Heath Limited. All rights reserved

Allen & Heath Limited

Kernick Industrial Estate, Penryn, Cornwall, TR10 9LU, UK

<http://www.allen-heath.com>

PACKED ITEMS

Check that you have received the following:

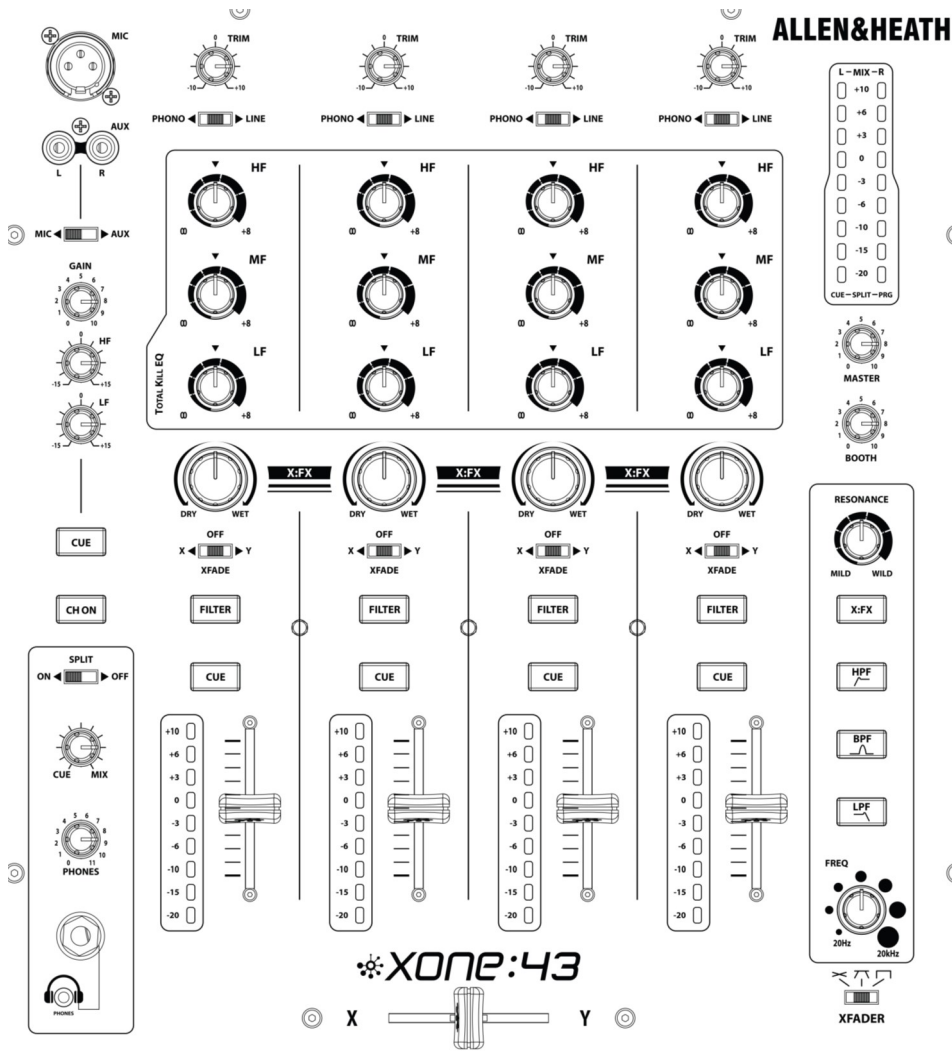

Xone:43 mixer

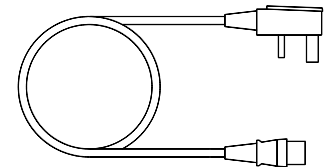

Mains Lead

Check that the correct mains plug is fitted.

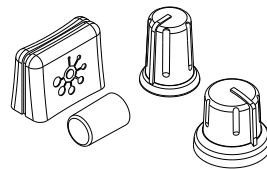

Spare knobs and buttons

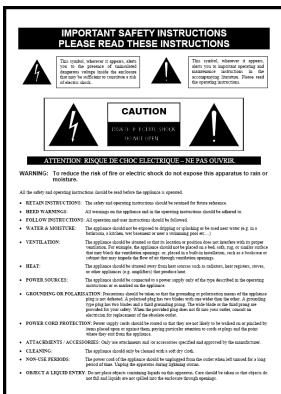

Safety Sheet

Important ! Read this sheet before starting.

Retain for future reference.

CONTENTS

Congratulations on purchasing the Allen & Heath Xone:43 DJ mixer.

The Xone:43 is a DJ mixer featuring four stereo dual input channels, a Mic/Aux input channel, 45mm linear VCA channel faders, Xone VCF filter, and X:FX external effects loop for send/return functionality with wet/dry control.

To ensure that you get the maximum benefit from the unit please spare a few minutes familiarizing yourself with the controls and setup procedures outlined in this user guide. For further information please refer to the additional information available on our website, or contact our product support team.

<http://www.allen-heath.com>

Warranty	2
Packed Items.....	3
Contents.....	4
Setup Examples	5
Mic / Aux Channel Input	6
Phono / Line Input Channels 1 to 4.....	7
Filter Section	9
Headphone Section.....	10
Master Section	11
Crossfader	12
Rear Connectors	13
Panel Drawings.....	15
Specifications	16
Block Diagram.....	17
Filter Reference	18
Operating Levels.....	19
Earthing.....	20
Replacing the Crossfader	21

SETUP EXAMPLES

CLASSIC VINYL

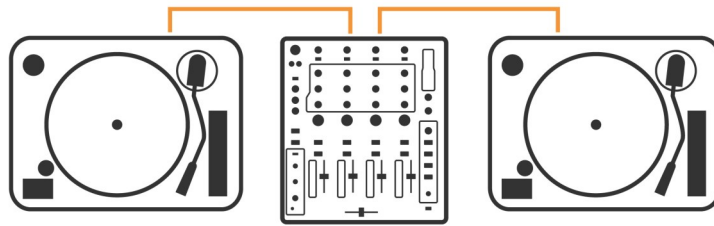

CD / MEDIA PLAYERS + FX UNIT

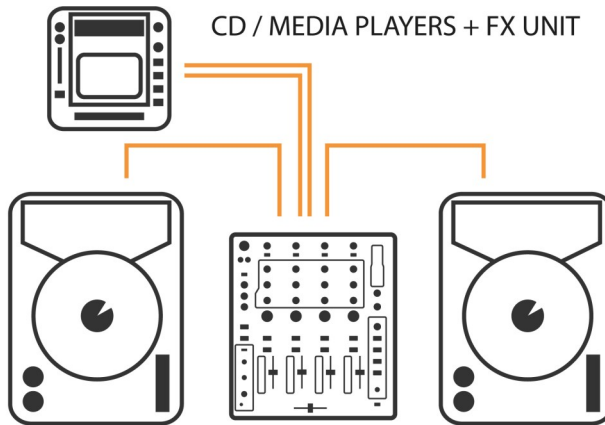

DIGITAL VINYL SYSTEM WITH EXTERNAL SOUND CARD

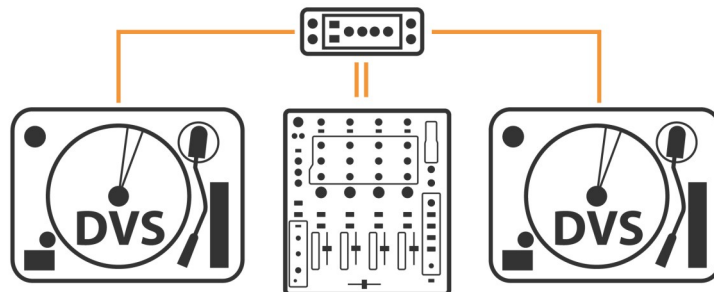

VINYL + CD / MEDIA PLAYERS

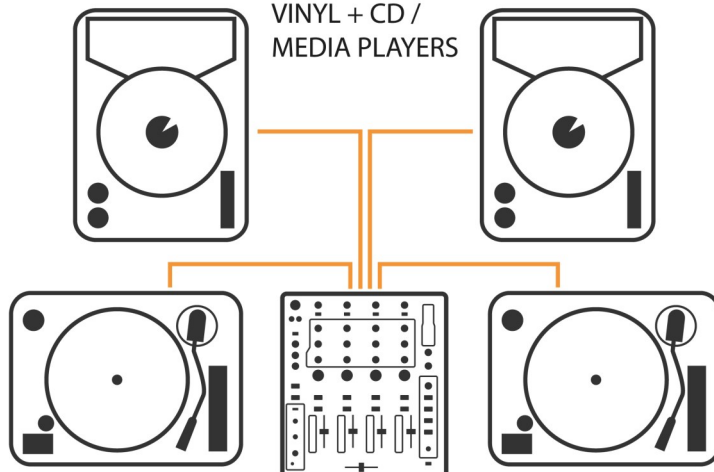

MIC / AUX INPUT CHANNEL

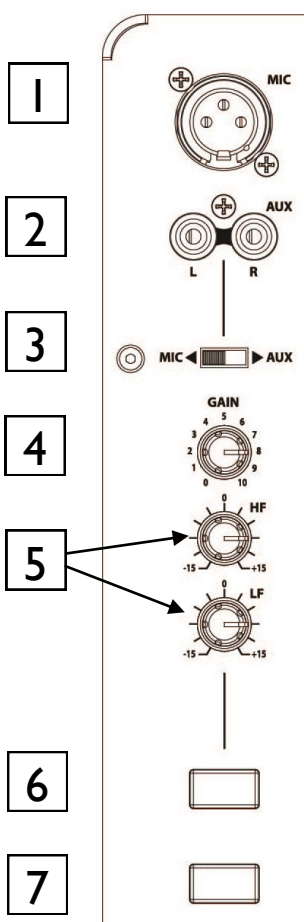

1 Mic Input

Standard 3-Pin XLR socket wired as Pin 1 = Ground, Pin 2 = hot (+), Pin 3 = cold (-).

2 Aux Input

Dual RCA sockets for connecting an external line level source.

3 Mic / Aux Select Switch

Selects either the XLR microphone input or the alternative Aux input.

4 Channel Gain Control

Adjusts the input sensitivity of the Mic / Aux channel to compensate for different source signal levels.

5 Channel Equaliser

The Mic / Aux input channel is equipped with a 2 band EQ stage providing +15dB of boost when fully clockwise and -15dB attenuation when fully anti-clockwise.

6 Cue Switch

Press the Cue switch to listen to the pre-channel on signal in the headphones and view its level on the main meters. Press the switch again to deselect cue.

7 Channel On Switch

Press the Channel On switch to send the channel audio to the main mix.

PHONO / LINE INPUT CHANNELS 1, 2, 3 and 4

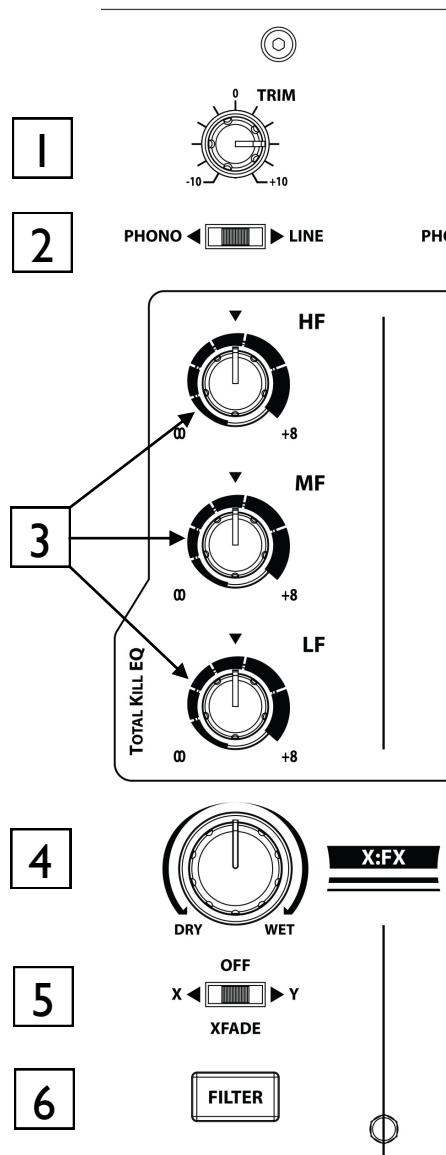

1 Channel Level Control

This control has a range from -10dB to +10dB. Use it to adjust the signal level of an audio source to give a nominal 0dB reading on the channel meter, with the peak level at or below 6dB.

2 Phono / Line Select Switch

Selects either the RCA phono input or the alternative RCA stereo line input.

3 Channel Equalizer / Isolator

The Xone:43 is equipped with a very powerful 3 band EQ providing a controlled +6dB of boost when fully clockwise, but dramatic cut of each band when fully anti-clockwise. Centre frequencies are set at:

- HF = 3.8kHz (high frequency, treble)
- MF = 1kHz (mid frequency)
- LF = 310Hz (low frequency, bass)

4 X:FX Dry / Wet Send

Use this control to vary the amount of channel signal that is sent to an external effects device connected to the X:FX send / return on the rear panel. With this control set to 'dry', none of the signal is routed to the external effects loop. With the control in the central position, half of the signal is sent to external effects, while the other half is unaffected or, if filter is selected, only the dry part of signal is filtered. With the control set to fully 'wet', all of the signal is sent to external effects and the VCF filter is bypassed.

5 XFade Assign Switch

Used to assign the channel to either the X (left), Off (middle) or Y (right) side of the cross-fader.

6 Filter Select

Press to route the channel signal through the VCF filter. The switch will illuminate to indicate that the channel is being sent to the filter.

PHONO / LINE INPUT CHANNELS 1, 2, 3 and 4

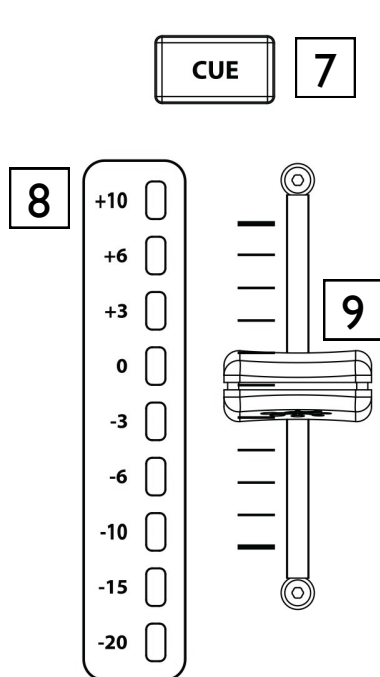

7 Cue Switch

Press the Cue switch to listen to the channel pre-fade signal in the headphones and see its level on the main meters. Press the switch to deselect cue.

8 Channel Meter

Displays the channel signal level. It is pre-EQ and pre-fader, allowing the input level to be displayed even if the EQ is set to off on all bands.

The channel level control should be set so that the meter averages around '0' with loudest peaks no higher than '+6'. Turn down the level control if the +10 indicator lights.

9 Channel Fader

A high quality, smooth travel fader adjusts the channel signal level from fully off to fully on.

FILTER SECTION

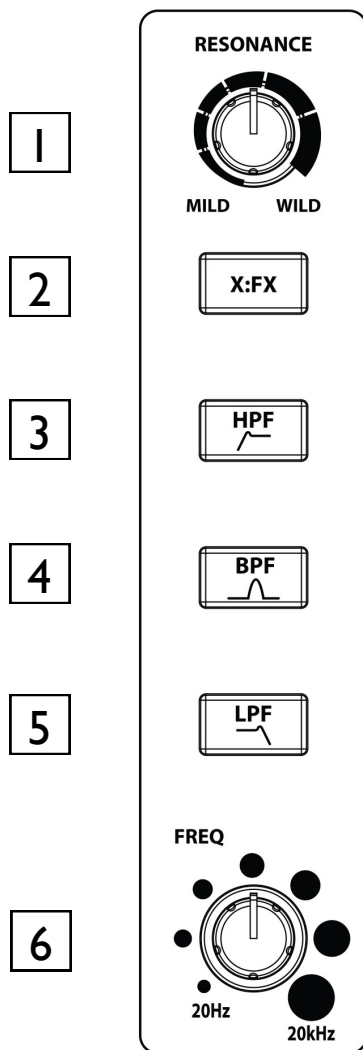

1 Resonance Control

This produces the classic Xone VCF sound by feeding some of the filter output back to its input. The control ranges from 'mild' producing a very subtle effect, to 'wild' producing a dramatic phase effect with feedback just short of oscillation.

2 X:FX Return to Filter

Pressing this button routes the X:FX return to the VCF filter, instead of directly into the main mix buss. The effected channel signal can then be filtered as well, allowing extra versatility and creativity to be brought into the mix.

3 HPF

Turns on the high pass (bass cut) filter slope.

4 BPF

Turns on the band pass (bell shaped) filter slope.

5 LPF

Turns on the low pass (treble cut) filter slope.

6 Frequency Sweep Control

This control sets the -3dB cut-off frequency of the filter. It ranges from very low frequency (20Hz) to very high frequency (20kHz).

HEADPHONE SECTION

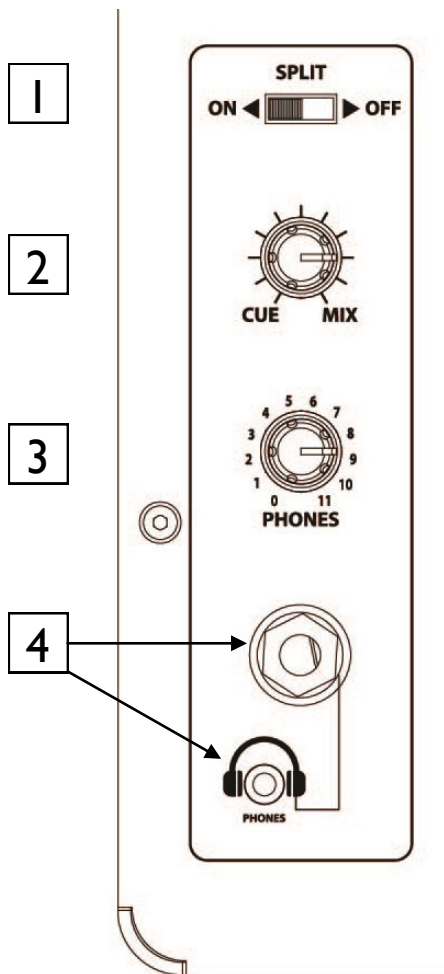

1 Split Cue Switch

Selects the way Cue operates. Normally, pressing a channel Cue switch overrides both left and right monitor program signals with the stereo Cue signal. With Split set to On, Cue overrides just the left channel leaving the program in the right channel. The left monitor meter displays the Cue signal, right displays program. This is very useful when beat mixing using headphones.

2 Cue / Mix Control

Allows the main mix output to be added to the Cue signal. Turned fully anticlockwise, only the active Cue is heard through the headphones when Cue is active. Gradually turning clockwise introduces the main mix output to the headphones, together with the active Cue. Selecting Split Cue will automatically override this control.

3 Headphones Level Control

Adjusts the level of the signal in the stereo headphones. This does not affect the level of the local booth monitor.

4 Headphone Outputs

Stereo 1/4" TRS jack and 3.5mm mini-jack sockets. Plug in good quality stereo headphones intended for DJ monitoring. Use closed-ear headphones that provide maximum acoustic isolation when cueing your sources.

MASTER SECTION

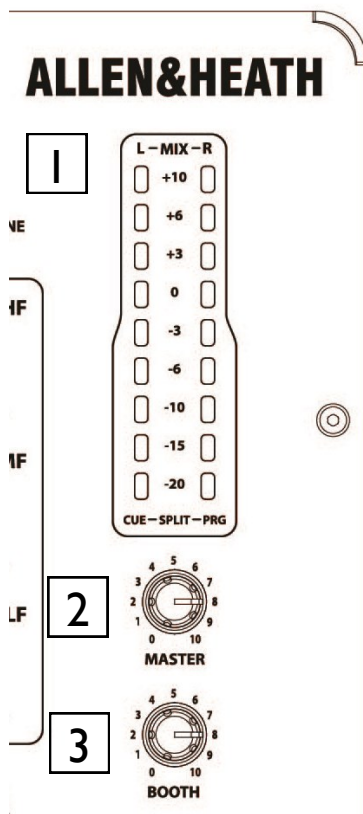

1 Mix / Monitor Meters

The main meters follow the selected monitor source. The default display is the mix level, pre-master level, which is overridden with an input channel level if the channel cue switch is selected.

In split cue mode, the left (L) mix meter will display the cued channel signal level and the right (R) mix meter will display the mix level. The cued mix audio is pre level to prevent mismatch due to the position of the master level control.

The mixer should be operated with these meters averaging around '0' with loudest peaks no higher than '+6'.

2 Master Level Control

A rotary master control adjusts the level of the master mix XLR outputs feeding the house sound system. This does not affect the booth output or the meter reading.

3 Booth Level Control

Adjusts the level of the signal to the stereo booth RCA output. This does not affect the headphones. The booth output could be used for a booth monitor, recording or an additional zone feed.

CROSSFADER



1

Crossfader

This lets you fade between signals routed to either side, typically to fade smoothly into a new music track or to creatively layer sounds when scratch or cut mixing.

The crossfader is a VCA controller which affects the level of signals routed via the filters. Make sure the switches on the channels you wish to fade are set to X or Y as appropriate.

2

Crossfader Curve Control

This control adjusts the crossfader curve between dipped, dipless and fast-cut, better suited for scratch or cut mixing.

REAR CONNECTORS

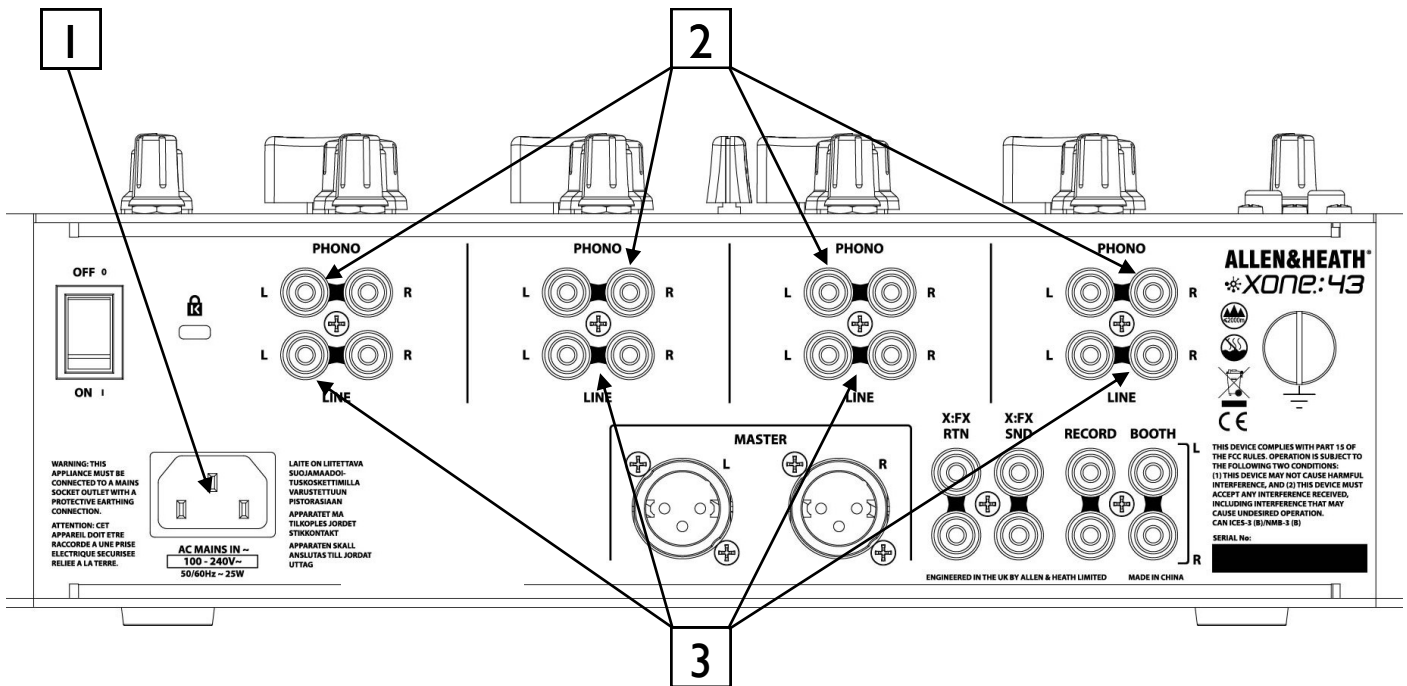

1 AC Mains Input

IEC cable with moulded mains plug suitable for your local supply.

Important: Read the **SAFETY INSTRUCTIONS** sheet included with the Xone:43 and printed on the rear panel.

Check that the correct mains lead with moulded plug has been supplied with your console. The power supply accepts mains voltages within the range 100-240V without changing any fuses or settings. Ensure that the IEC mains plug is pressed fully into the rear panel socket before switching on.

Note: It is standard practice to turn connected power amplifiers down or off before switching the console on or off. This prevents any potential damage to speaker systems due to switch-on transients.

2 CH 1, 2, 3 and 4 Phono Input

Plug in turntables with magnetic cartridges requiring RIAA equalisation. For non-RIAA turntables plug into the LINE input instead. Do not plug in line level sources to the phono inputs as these will overload the preamp and cause severe high level distortion.

3 CH 1, 2, 3 and 4 Line Input

RCA phono. Connect stereo line level music sources such as CD players. Do not connect turntables which require RIAA equalisation. Alternatively, you can connect to jack sources using a cable with RCA to jack adapters. Avoid using low grade cables such as those often supplied with domestic equipment as these can quickly prove unreliable in use.

REAR CONNECTORS

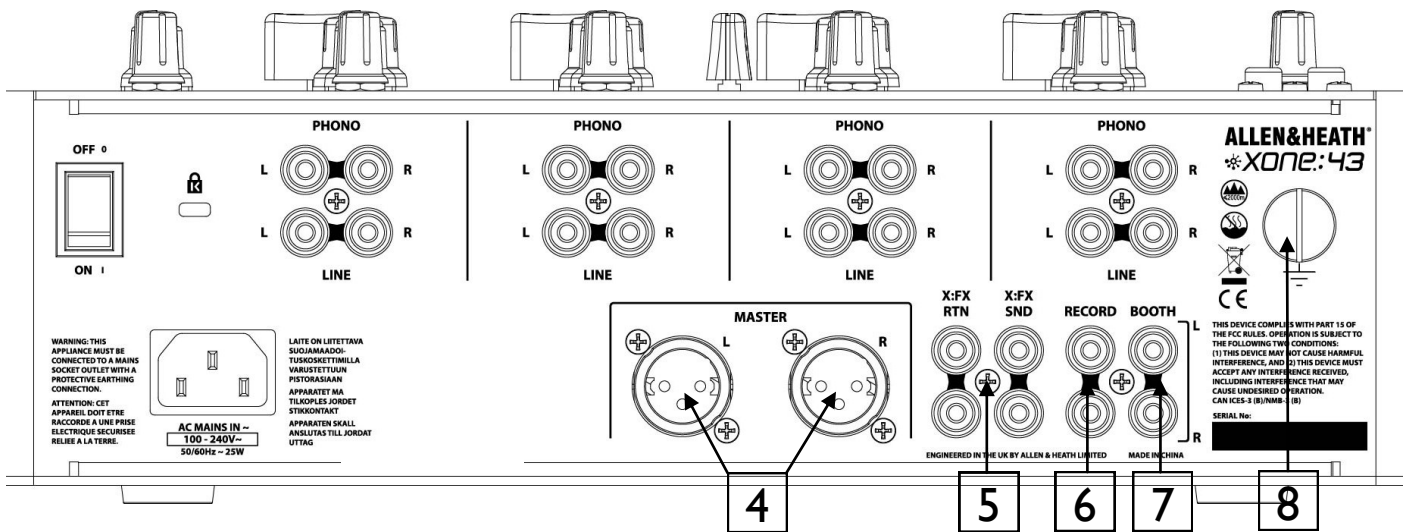

4 Master Output

Balanced XLR. This is the main output that feeds the house PA system. Plug into the house processor/amplifier system using balanced cables. Use balanced cables and equipment. When the main meter LEDs are at “0dB” the output will nominally be at +4dBu. Do not unbalance this output by shorting one phase to ground—for unbalanced operation use pin 2 only.

X:FX Send/Return

5 RCA phono. Connect your external effects device and use the X:FX dry / wet control to send channel signals to the effects unit. The signal returns to the mix bus but can be routed to the VCF filter by pressing the ‘X:FX’ button on the front panel filter section. This allows the filter to be ‘stacked’ with an external effects device.

6 Record Output

RCA Phono, nominal 0dBu. Pre-level mix output for connection to external recording devices.

7 Booth Output

RCA phono, 0dBu. Provides a line level stereo feed to the DJ local monitor amplifier system. It is not affected by the master fader or cue system.

8 Chassis Earth Terminal

A screw terminal is provided for connecting the earth straps from turntables. This connection earths the metal parts of the turntable to reduce hum, buzz or similar audible noise getting into the system.

PANEL DRAWINGS

Rear Panel

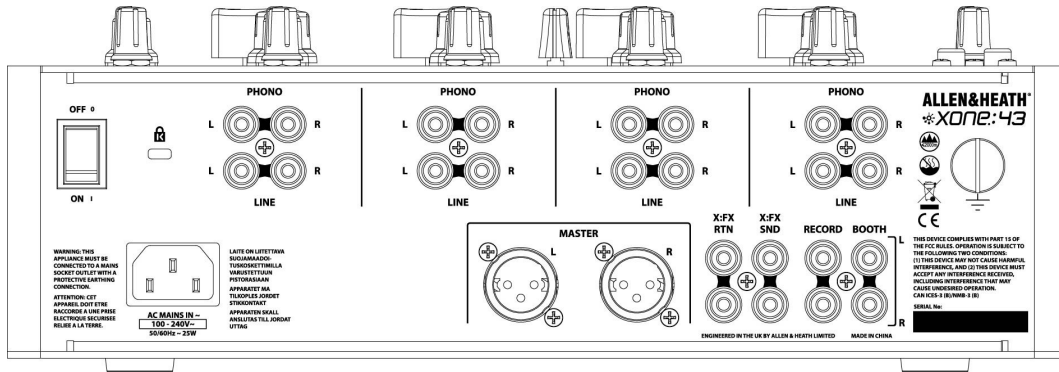

Front Panel

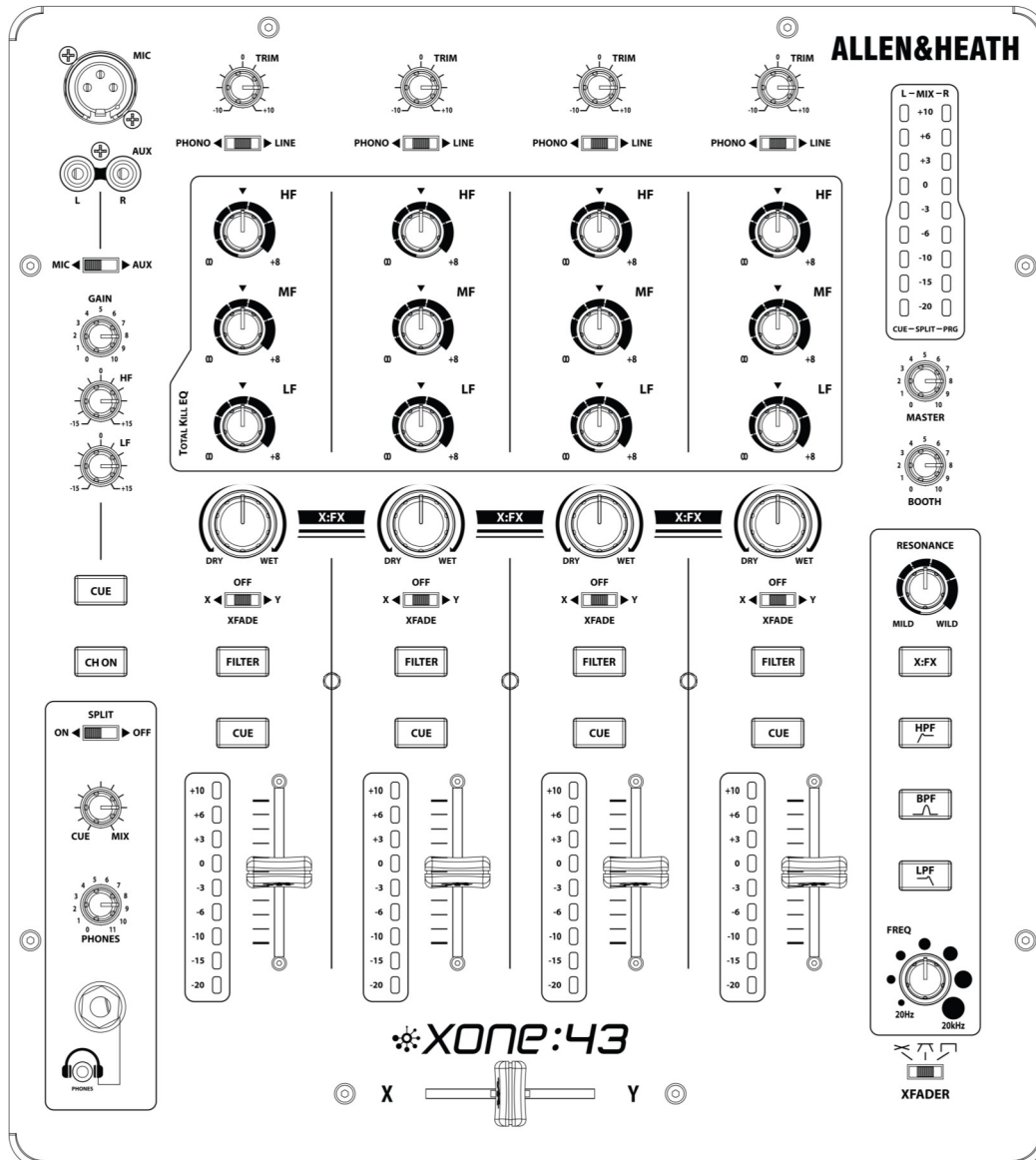

SPECIFICATIONS

Nom / max output levels	Main Mix	+4dBu	+27dBu
	Booth	0dBu	+22dBu
	X:FX Send	0dBu	+20dBu
	Record Out	0dBu	+20dBu
Internal headroom	Channels +20dB		
Frequency response	+/-0.5dB 20Hz - 20kHz		
Distortion	< 0.05% THD+noise @1kHz		
Crosstalk	< -83dB inter-channel		
Residual noise	Mix I	-89dBu	
	Booth	-93dBu	
	X:FX	-77dBu	
	Rec	-92dBu	
Mix noise	Mix I	-82dBu	
	Booth	-84dBu	
	X:FX	-77dBu	
	Rec	-87dBu	
Channel meters	Peak reading 9 LED -20dB to +10dB		
Main meters	Peak reading 9 LED -20dB to +10dB		
Mic EQ	2-Band +/-12dB		
Channel EQ	3-Band +6dB / total kill		
Channel fader	45mm stereo VCA, < -85dB shutoff		
Crossfader	45mm stereo VCA - replaceable		
Filters	Stereo VCF, analogue		
Consumption	30W max		

Dimensions and Weights

The console is fitted with rubber feet for desktop operation.

	Width	Height	Depth	Weight
Mixer	320 mm	110mm	370mm	5.1 kg

BLOCK DIAGRAM

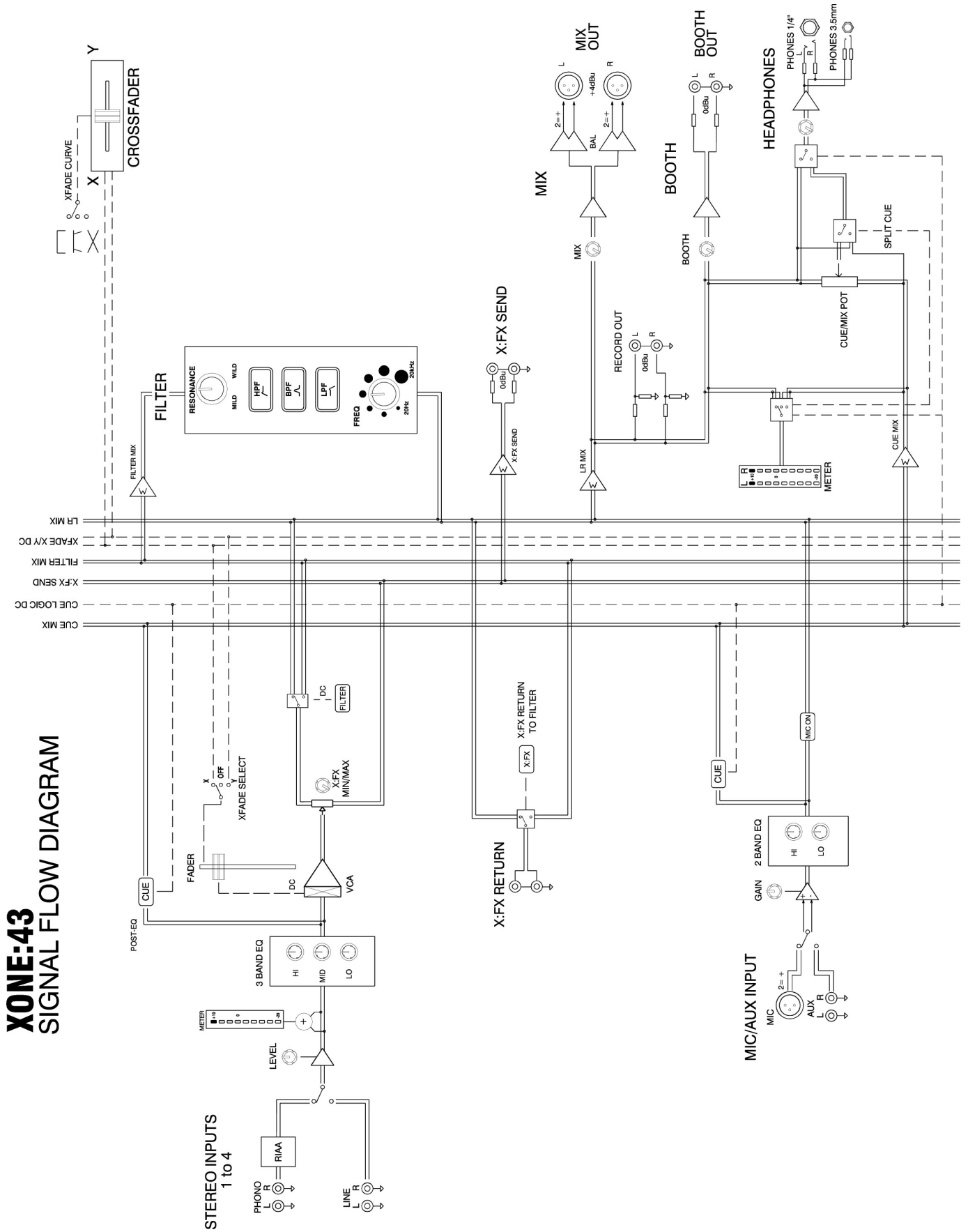

XONE:43 SIGNAL FLOW DIAGRAM

FILTER REFERENCE

The VCF Filters

A voltage controlled filter is an audio filter where the cut-off frequency is altered by a DC control voltage rather than a variable resistor. This produces a much wider operating range and more control over the filter response to create unlimited combinations of tonal effect.

Filter Type Select

The filters are 'state variable'. This means that they provide three simultaneous filter types: high-pass, band-pass and low-pass. Three large illuminated switches select which type is active. You can press any combination together to create different response types such as 'notch' and an interesting 'all-pass' effect. The switches are 'soft switched' for live performance, meaning that the audio signal is ramped between filter states to prevent audible clicks.

Note that the last selected type is lost when power is removed from the console. The LPF is always selected when power is applied.

The graphs below show the effect on the audio frequency response for the three filter types. The range of sweep from low to high frequency is shown together with the effect of adjusting RESONANCE (one frequency with several resonance settings shown).

The vertical scale shows the amount of cut or boost around the normal 0dB operating level. The horizontal scale shows the change in frequency from low (bass) to high (treble).

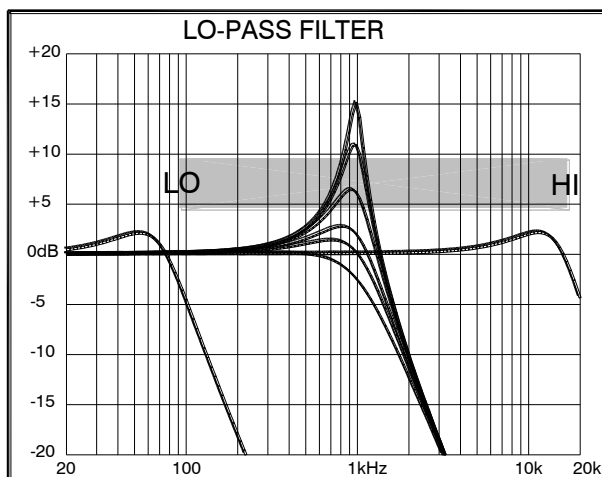
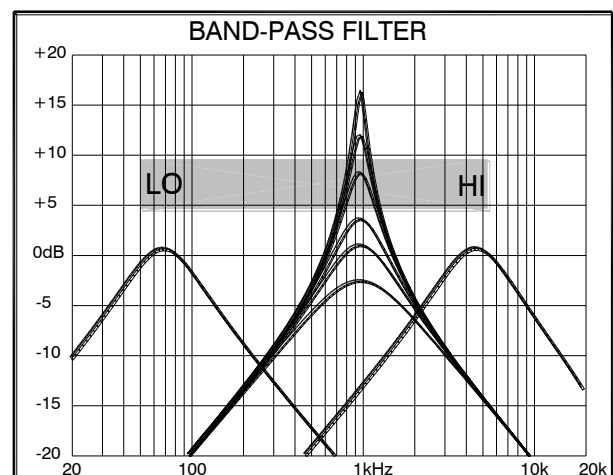
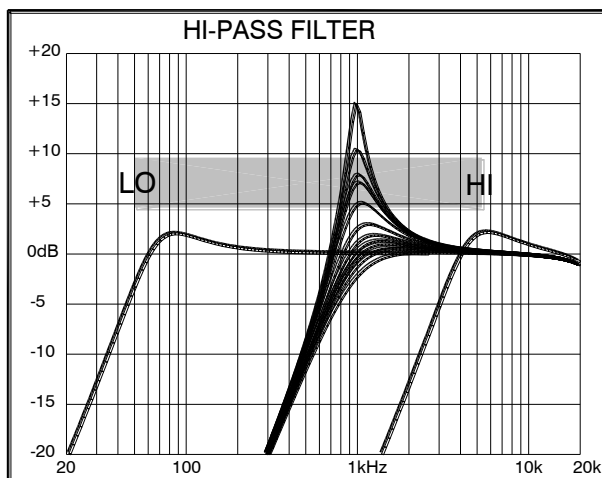

OPERATING LEVELS

It is most important that the system level settings are correctly set. It is well known that many DJs push the level to maximum with meters peaking hard in the belief that they are getting the best from the system. **THIS IS NOT THE CASE !** The best can only be achieved if the system levels are set within the normal operating range and not allowed to peak. Peaking simply results in signal distortion, not more volume. It is the specification of the amplifier / speaker system that sets the maximum volume that can be achieved, not the console. The human ear too can fool the operator into believing that more volume is needed. Be careful as this is in fact a warning that hearing damage will result if high listening levels are maintained. Remember that it is the **QUALITY** of the sound that pleases the ear, not the **VOLUME**.

The diagram below illustrates the operating range of the audio signal.

NORMAL OPERATING RANGE. For normal music the signal should range between -6 and $+6$ on the meters with average around 0 dB. This allows enough **HEADROOM** for unexpected peaks before the signal hits its maximum **CLIPPING** voltage and distorts.

It also achieves the best **SIGNAL-TO-NOISE-RATIO** by keeping the signal well above the residual **NOISE FLOOR** (system hiss).

The **DYNAMIC RANGE** is the maximum signal swing available between the residual noise floor and clipping.

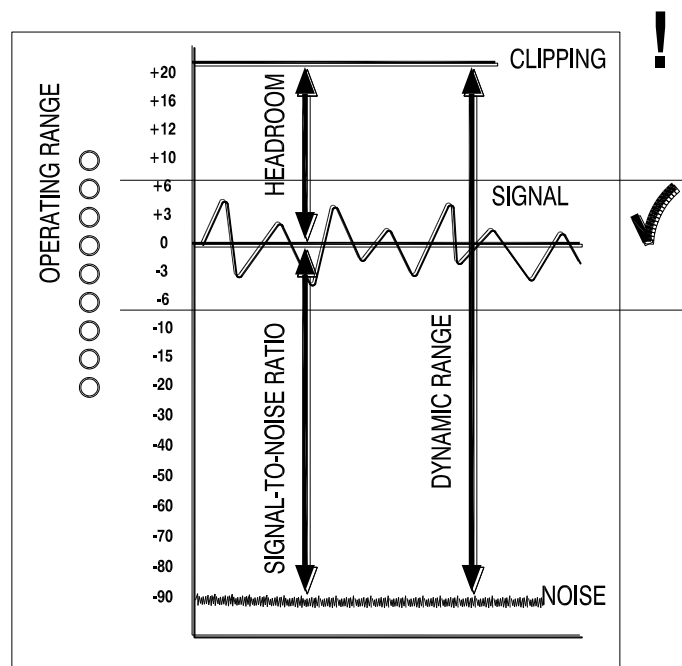

An important note ...

The human ear is a remarkable organ with the ability to compress or 'shut down' when sound levels become too high. Do not interpret this natural response as a reason to turn the system volume up further ! As the session wears on ear fatigue may set in, and the speaker cones may become hot so reducing the effectiveness of the system and listeners to gain any benefit from increased volume.

EARTHING

The connection to earth (ground) in an audio system is important for two reasons:



SAFETY - To protect the operator from high voltage electric shock, and

AUDIO PERFORMANCE - To minimise the effect of earth (ground) loops which result in audible hum and buzz, and to shield the audio signals from interference.

For safety it is important that all equipment earths are connected to mains earth so that exposed metal parts are prevented from carrying high voltage which can injure or even kill the operator. It is recommended that a qualified system engineer check the continuity of the safety earth from all points in the system including microphone bodies, turntable chassis, equipment cases, and so on.

The same earth is also used to shield audio cables from external interference such as the hum fields associated with power transformers, lighting dimmer buzz, and computer radiation. Problems arise when the signal sees more than one path to mains earth. An 'earth loop' (ground loop) results causing current to flow between the different earth paths. This condition is usually detected as a mains frequency audible hum or buzz.

To ensure safe and trouble-free operation we recommend the following:

Have your mains system checked by a qualified electrician. If the supply earthing is solid to start with you are less likely to experience problems.

Do not remove the earth connection from the console mains plug. The console chassis is connected to mains earth through the power cable to ensure your safety. Audio 0V is connected to the console chassis internally. If problems are encountered with earth loops operate the audio 'ground lift' switches on connected equipment accordingly, or disconnect the cable screens at one end, usually at the destination.

Make sure that turntables are correctly earthed. A chassis earth terminal is provided on the console rear panel to connect to turntable earth straps.

Use low impedance sources such as microphones and line level equipment rated at 200 ohms or less to reduce susceptibility to interference. The console outputs are designed to operate at very low impedance to minimise interference problems.

Use balanced connections for microphones and mix output as these provide further immunity by cancelling out interference that may be picked up on long cable runs. To connect an unbalanced source to a balanced console input, link the cold input (XLR pin 3 or jack ring) to 0V earth (XLR pin 1 or jack sleeve) at the console. To connect a balanced XLR output to unbalanced equipment, link the cold output to 0V earth at the console.

Use good quality cables and connectors and check for correct wiring and reliable solder joints. Allow sufficient cable loop to prevent damage through stretching.

If you are not sure ... Contact your service agent or local Allen & Heath dealer for advice.

REPLACING THE CROSSFADER

If the crossfader is subject to a lot of use it will, in time wear out and need replacing. Intermittent or noisy operation is an indication that it is becoming worn. Using a propriety fader cleaner such as CaigLube might temporarily restore use, but **DO NOT** use on a new fader as it will wash away the factory applied grease.

The standard fader can be ordered under A&H part number 004-632JIT

The Innofader can be ordered under part number 004-504JIT

Warning! Dismantling your mixer could invalidate the warranty; if you are unsure of your ability to safely carry out this work then it is advised that you leave it to a qualified service technician.

Tools you will need:

- T8 Torx screwdriver
- A small container to keep screws in.

Have a clean flat work surface ready before starting work.

Ensure that the power to the unit has been turned off and disconnected completely from the mains.

Step 1:

- Remove and retain 2 screws from front panel.
- Remove and retain 4 screws from rear panel upper phono sockets.



Step 2:

- Remove and retain 4 screws from side panel of the mixer (2 each side).
- Turn console over onto its front panel – take care not to scratch the unit.



Step 3:

- Remove and retain 6 screws from base panel.
- Note that the 2 nearest the rear connector remain in place.
- Turn console over to be the correct way up.

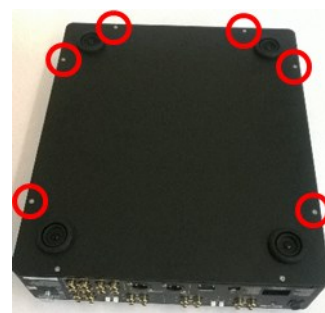

REPLACING THE CROSSFADER

Step 4:

- Gently slide the two halves of the console apart until the rear connector PCB is wholly visible.

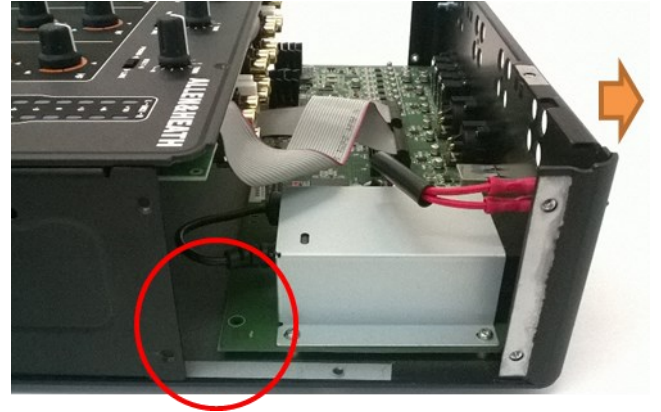

Step 5:

- With care unplug the grey flat wireform from the connector PCB.
- The console base and front panel can now be separated.



Step 6:

- Remove the crossfader cap.
- Remove and retain 2 screws from crossfader front panel.

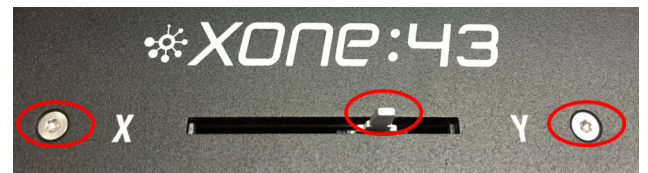

Step 7:

- With care unplug the white harness from the connector PCB.
- The cross fader and plate can now be separated.

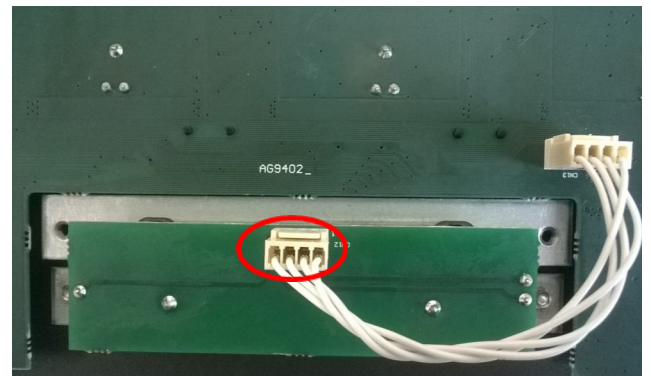

Step 8:

- Remove and retain 2 screws from crossfader plate.
- Note that these 2 screws from the cross fader plate are a different size length, do not mix them up with the other screws.



REPLACING THE CROSSFADER

Step 9:

- Fit the new replacement crossfader to the bracket as shown (slot 1).
- The longer (slot 2) beneath is for mounting the optional Innofader (not supplied). The standard crossfader must be fitted to slot 1 and not slot 2.

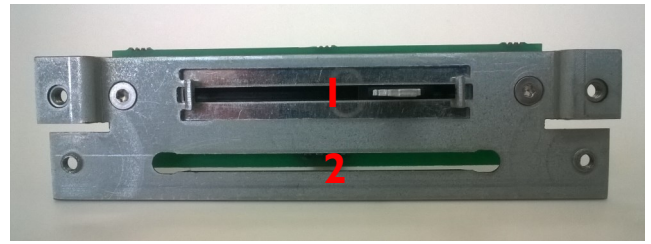

Step 10:

- Screw the crossfader plate back to the console.
- Replace the crossfader cap.
- Connect the white harness from the connector PCB.



Step 11:

- Re-assembly of the console is the reverse of steps 1-5. When re-assembling the console take great care to refit the wireform fully into the socket.