



User Guide





IMPORTANT

Please read this manual carefully before using your mixer for the first time.



This equipment complies with the EMC directive: EMC 2004/108/EC

And low voltage: Low Voltage 2006/95/EC

This product is approved to safety standards:

IEC 60065:2001 + Amd 1:2005

EN 60065:2001 + Amd 1:2006 + A11:2008

UL 60065-07, CSA C22.1 No 60065-03 + Amd 1:2006

And EMC standards: EN55103-1:2009, EN55103-2:2009

Warning: Any modification or changes made to this device, unless explicitly approved by Harman, will invalidate the authorisation of this device. Operation of an unauthorised device is prohibited under Section 302 of the Communications act of 1934, as amended, and Subpart 1 of Part 2 of Chapter 47 of the Code of Federal Regulations.

NOTE: This equipment has been tested and found to comply with the limits for a Class B digital device, pursuant to Part 15 of the FCC Rules. These limits are designed to provide reasonable protection against harmful interference in a residential installation. This equipment generates, uses and can radiate radio frequency energy and, if not installed and used in accordance with the instructions, may cause harmful interference to radio communications. However, there is no guarantee that interference will not occur in a particular installation. If this equipment does cause harmful interference to radio or television reception, which can be determined by turning the equipment off and on, the user is encouraged to try to correct the interference by one or more of the following measures:

- * Reorient or relocate the receiving antenna
- * Increase the separation between the equipment and the receiver
- * Connect the equipment into an outlet on a circuit different from that to which the receiver is connected.
- * Consult the dealer or an experienced radio/TV technician for help

For further details contact

Harman International Industries Ltd, Cranborne House, Cranborne Road, Potters Bar, Hertfordshire EN6 3JN, UK
Telephone +44(0) 1707 665000 Fax +44 (0)1707 660742 email: soundcraft@harman.com

© Harman International Industries Ltd. 2010

All rights reserved

Parts of the design of this product may be protected by worldwide patents.

Part No. BD10.947002 Rev1 Issue 0910

E&OE September 2010

Soundcraft is a trading division of Harman International Industries Ltd. Information in this manual is subject to change without notice and does not represent a commitment on the part of the vendor. Soundcraft shall not be liable for any loss or damage whatsoever arising from the use of information or any error contained in this manual.

No part of this manual may be reproduced, stored in a retrieval system, or transmitted, in any form or by any means, electronic, electrical, mechanical, optical, chemical, including photocopying and recording, for any purpose without the express written permission of Soundcraft.



Harman International Industries Limited

Cranborne House, Cranborne Road, Potters Bar, Hertfordshire, EN6 3JN, UK

Tel: +44 (0)1707 665000

Fax: +44 (0)1707 660742

<http://www.soundcraft.com>

Contents

INTRODUCTION	1 - 1
IMPORTANT SAFETY INSTRUCTIONS	1 - 2
SAFETY SYMBOL GUIDE	1 - 4
INSTALLATION	1 - 5
WORKING SAFELY WITH SOUND	1 - 6
WARRANTY	1 - 7
Soundcraft Vi1™ FEATURES AND SPECIFICATIONS	1 - 8
Audio Channels.....	1 - 8
I/O Capability.....	1 - 8
Miscellaneous.....	1 - 8
Channel Processing.....	1 - 9
Control Surface.....	1 - 9
CONSOLE OVERVIEW	1 - 11
Bays	1 - 11
Layers.....	1 - 12
Encoders.....	1 - 13
Master Audio Functions.....	1 - 14
Master Control.....	1 - 15
SYSTEM COMPONENTS	2-1
SYSTEM HARDWARE OVERVIEW	2-2
THE CONSOLE REAR CONNECTORS	2-3
Mains Power Supply Inlet	2-3
Audio And Data Rearcon.....	2-3
OPTIONAL STAGE BOX	2-5
Stage Box Description	2-5
Card Function Overview	2-5
Redundant MADI Cable Operation	2-6
Front Panel	2-7
OPERATION OVERVIEW	3-1
GENERAL RULES	3-1
CONVENTIONS USED IN THIS MANUAL	3-1
SCREENS	3-1
Input Screens	3-1
Screen Colour Codes.....	3-2
WIDESCREEN VISTONICS™ KNOBS	3-3
AUDIO FUNCTION STATES	3-3
MOMENTARY/LATCHING CONTROL ACTION	3-3
SOLO/SEL KEYS	3-4
LABELLING	3-4
General.....	3-4
Channel Labels	3-5
BUS CONFIGURATION	3-6
GANG	3-7
General.....	3-7
Creating A Gang.....	3-7
Switching-Off Gang Mode.....	3-7
Clearing A Gang.....	3-7
Gang All Input Channels.....	3-7

INPUT	4-1
SIGNAL FLOW	4-1
INPUT CHANNEL STRIP	4-2
INPUT CHANNEL TOUCH FIELDS	4-3
Change A Parameter Of An Input Channel	4-3
INPUT	4-4
INPUT field.....	4-4
GAIN field	4-4
TRIM field	4-4
LO CUT field	4-4
HI CUT field	4-5
FORMAT field	4-5
PAIRING field	4-5
PHANTOM field.....	4-5
PHASE field	4-5
IN1 PATCH field.....	4-5
IN2 PATCH field	4-5
CH Label field	4-5
DLY field	4-5
STEREO CONFIGURATION	4-6
Pairing of input channels.....	4-6
Pair An input Channel.....	4-6
EQUALISER	4-7
General.....	4-7
Equaliser Band Highlight.....	4-8
BAND Field	4-8
SHELF Switch.....	4-8
EQUALISER Field	4-8
DYNAMICS	4-9
General.....	4-9
GATE Function.....	4-9
DE-ESS Function	4-11
COMPRESSOR Function.....	4-12
LIMITER Function	4-12
MKUP	4-12
BUS	4-13
General.....	4-13
AUX (Mono)	4-13
AUX (Stereo).....	4-13
GRP (Mono).....	4-13
GRP (Stereo)	4-13
Empty	4-13
PANNING	4-14
General.....	4-14
PAN Function LR Mode	4-14
PAN Function LCR Mode.....	4-15
AUDIO FORMAT	4-16
General.....	4-16
Input Channels	4-16
Mix Busses	4-16
Masters	4-16
PAN/BAL	4-17
INSERT Function	4-18
Direct Out Function.....	4-18

OUTPUTS	5-1
SIGNAL FLOW	5-1
GENERAL	5-2
L,R & C Master Processing	5-3
MASTER EQ LINKING (V2.0 Software and above)	5-4
Default settings	5-4
MASTER BAY OUTPUT STRIPS	5-5
Bus Master Processing	5-6
INPUT BAY STRIP USING [ALL BUSSES]	5-6
MASTER BAY VISTONICS™ ENCODERS & KEYS	5-7
VST Key Function.....	5-7
CHANGING OUTPUT BUS PARAMETERS	5-8
Changing A Parameter Of A Bus	5-8
EQUALISER	5-9
DYNAMIC	5-9
PAN	5-10
LOW CUT Field	5-10
PHASE Field.....	5-10
DLY Field	5-10
MATRIX	6-1
SIGNAL FLOW	6-1
FUNCTION	6-1
Adjusting A Matrix Send Level.....	6-2
MATRIX CONFIGURATION	6-2
SOURCE field	6-2
MTX Point Field.....	6-3
ENCODERS	7-1
GENERAL INTRODUCTION	7-1
CHANNEL ENCODERS	7-2
CHANNEL VST ENCODER 1& 2	7-3
VST Encoder Priority	7-3
Changing Encoder Function	7-3
MASTER BAY PANEL ENCODERS	7-5
MASTER BAY VST ENCODERS	7-5
Master Vistonics Switch Function Panel.....	7-5
LAYERING (FADER PAGES)	8-1
GENERAL	8-1
INPUTS	8-1
Temporary Layer	8-2
User Layers.....	8-2
OUTPUTS	8-4
Master Fader section	8-4
ALL Busses	8-5
VST Master Area.....	8-6

VCA & MUTE GROUPS	9-1
VCA/MUTE GROUP INDICATION	9-1
MUTE GROUP MASTER SWITCHES	9-2
VCA CONTROL GROUP BEHAVIOUR.....	9-2
AUDIO BEHAVIOUR.....	9-2
ASSIGNING VCAs.....	9-3
ASSIGNING MUTE GROUPS.....	9-3
ASSIGNING VCAs AND MUTE GROUPS TO OUTPUT CHANNELS	9-3
VCA GROUPS WHEN AUX SENDS ARE CONTROLLED BY CHANNEL FADERS.....	9-3
Procedure.....	9-4
PATCH SYSTEM	10-1
SIGNAL FLOW.....	10-1
OVERVIEW	10-2
GENERAL RULES	10-2
INPUT	10-3
Patch A Source To An Input Channel.....	10-3
Using A Spare Mic For Several Inputs.....	10-4
OUTPUT	10-5
Patch a BUS to an OUTPUT.....	10-5
INSERT	10-6
Patching An Insert Point To An Input Channel.....	10-6
Patching Insert Send Or Return Signals To The Connectors Or MADI Channels.....	10-6
Stereo Inserts	10-6
DIRECT OUT	10-7
KEY SIGNAL	10-8
MATRIX.....	10-8
TIE LINES	10-9
MONITORING	11-1
SIGNAL FLOW.....	11-1
FUNCTION	11-1
DESK VIEW.....	11-2
SOLO TRIM.....	11-2
SOLO BLEND	11-2
PHONES Volume	11-2
SETUP.....	11-2
Level Meter.....	11-2
PFL/AFL Indication	11-2
ON.....	11-3
Monitor Volume	11-3
Monitor B	11-3
MONITOR SETUP PAGE.....	11-4
SOLO Section.....	11-4
MNTR A Section	11-5
MNTR B and HP Sections	11-6
DLY Field	11-6
MONITOR SETUP SUB-PAGE	11-8
Output Solo Selection	11-8
SOLO SYSTEM	11-10
Solo Operation Logic	11-11
Input Priority Mode	11-12
Autocancel Behaviour.....	11-13
Follow Output Solo Mode.....	11-14

TALKBACK & OSCILLATOR	12-1
DESK VIEW	12-1
Setup Key	12-1
TB Mic XLR	12-1
TB / Osc Level control	12-1
Routing the TB signal	12-1
SETUP	12-2
OSC Section	12-2
TB Send Section	12-4
TB Return Section	12-5
METERING	13-1
Input Channel Meter	13-1
Bus Master Meters	13-2
Master Output Meters	13-2
Monitor Meters	13-2
Scale	13-2
Meters On The Master Section Screen	13-3
Touch Selection	13-3
Peak Hold	13-4
Ballistics	13-4
MAIN MENU	14 - 1
MAIN	14 - 1
SECURITY Field	14 - 1
BRIGHTNESS Control	14 - 1
SHOW	14 - 2
GPIO	14 - 2
SYNC	14 - 3
TIE LINES	14 - 3
FX	14 - 4
MIDI	14 - 4
LOG	14 - 5
SETTINGS	14 - 6
POINT	14 - 6
ENABLE NEXT/LAST	14 - 6
DEACTIVATE FADER TOUCH	14 - 6
SYSTEM MONITORING	14 - 7
Overview	14 - 7
DESK	14 - 8
LOCAL IO	14 - 9
STAGE BOX	14 - 10
HIQNET	14 - 11

SNAPSHOTS, CUES and SHOWS	15 - 1
SNAPSHOT FILTERING	15 - 1
FRONT PANEL DISPLAY AND CONTROLS	15 - 2
SETUP.....	15 - 2
DATA Socket.....	15 - 2
STORE.....	15 - 2
UNDO	15 - 3
PREV MODE	15 - 3
LAST	15 - 3
NEXT.....	15 - 3
The Arrow Keys and RECALL.....	15 - 3
SETUP	15 - 4
HIDE SCOPE/SHOW SCOPE Buttons	15 - 4
The Cue List Touch-Screen Controls	15 - 4
Cue List Display	15 - 5
Edit & Control Buttons	15 - 6
CUE NUMBERING	15 - 8
Snapshot Scope GUI	15 - 9
SCROLL CUE LIST	15 - 11
SHOW TIMECODES	15 - 11
APPLY CHANGES TO SCOPED PARAMS IN SELECTED CUES	15 - 12
CUE LIST PAGE - Cue Number Field Touched.....	15 - 13
CUE LIST PAGE - Cue NAME Field Touched.....	15 - 14
CUE LIST PAGE - MIDI Field Touched	15 - 16
MIDI OUT Setup	15 - 17
CUE LIST PAGE - MIDI Field Touched & Event List Open	15 - 19
CUE LIST PAGE - GPIO/Misc Field Touched	15 - 20
Global Filter	15 - 21
ISO Key Functionality	15 - 21
Press & Hold ISO Key Functionality.....	15 - 21
Global Filter ON/OFF switch	15 - 21
Edit Global Filter Mode	15 - 22
LOAD ISO WITH SHOW	15 - 23
MANAGING SHOWS	15 - 24
Flash Drive.....	15 - 24
Updating A Show.....	15 - 24
USB Data Storage Device	15 - 25
Exporting A Show To A USB Data Storage Device.....	15 - 25
Importing A Show From A USB Data Storage Device.....	15 - 25
Export/Import Channel Labels.....	15 - 25
Export Exception Files	15 - 25
RECORDED DATA	15 - 26
Settings Recorded Within A Show Snapshot's Show Settings.....	15 - 26
Settings Recorded Within Audio Settings	15 - 27
Settings Not Recorded	15 - 27
Settings Restored To Their State At the Last Power-Down.....	15 - 27
Show Compatability.....	15 - 27
GPIO (Stagebox only)	16-1
CONFIGURATION	16-1
Screen Touch-Pads	16-1
GPI VST Keys & Encoders.....	16-1
GPO VST Keys & Encoders.....	16-2
HARDWARE	16-4
Schematic Diagram	16-4
Pin Lists	16-5

SOUNDCRAFT FaderGlow™	17-1
GENERAL	17-1
Colour Code	17-1
COPY, PASTE & LIBRARIES	18 - 1
INTRODUCTION	18 - 1
CONSOLE CONTROL KEYS	18 - 1
COPY & PASTE PRINCIPLES	18 - 2
DATA SELECTION & INDICATORS	18 - 2
COPYING CHANNEL OR BUS PARAMETERS	18 - 3
COPYING A BUS MASTER INCLUDING ALL CHANNEL SEND LEVELS	18 - 3
PARAMETERS NOT INCLUDED IN CHANNEL & BUS COPY MODES	18 - 3
CHANNEL COPY: ITEMS NOT INCLUDED IN COPY WITH SEL BUTTON	18 - 4
BUS OUTPUT COPY: ITEMS NOT INCLUDED IN COPY WITH SEL BUTTON	18 - 4
EXAMPLE: COPYING A WHOLE CHANNEL, INCLUDING THE 'IN1 PATCH' PARAMETER	18 - 4
COPYING FX PARAMETERS	18 - 4
LIBRARIES	18 - 6
NAVIGATING AND MANAGING LIBRARIES	18 - 8
COPY TO LIBRARY	18 - 9
PASTE FROM LIBRARY	18 - 10
EXPORTING AND IMPORTING LIBRARIES	18 - 11
SOUNDCRAFT Vi1™ FEATURES AND SPECIFICATIONS	19-1
AUDIO CHANNELS	19-1
Max number of simultaneous mixing channels	19-1
Insert points	19-1
Direct Outputs	19-1
Busses.....	19-1
I/O CAPABILITY	19-1
CHANNEL PROCESSING	19-2
Inputs.....	19-2
Outputs.....	19-2
CONTROL SURFACE	19-2
Inputs.....	19-2
Outputs	19-2
Misc	19-3
Vi1 TYPICAL SPECIFICATIONS	19-4
Vi1 FX Processor	20-1
General	20-1
LEXICON® Effects.....	20-1
BSS® Graphic Equalisers	20-1
LEXICON® Effects Format	20-1
FX Overview Page	20-2
Snapshot integration	20-2
TAP	20-2
Assigning FX processors	20-4
Channel Insert	20-4
Master Insert.....	20-6
Return in Channel section	20-8
FX TYPE	20-10

FX DESCRIPTIONS	20-11
REVERBS	20-11
DELAYS	20-14
MISC EFFECTS	20-15
BSS® Graphic Equalisers.....	20-19

MIDI	21 - 1
Main Menu –MIDI page open & RX Channel list selected	21 - 1
DEVICE LISTS	21 - 1
Main Menu –MIDI page open & TX Channel list selected	21 - 3
Main Menu –MIDI page open & Transmit Device IDs list selected	21 - 4
MIDI Event Types	21 - 5

TECHNICAL INFORMATION

BLOCK DIAGRAM	22-1
Soundcraft Vi1 Block Diagram	22 - 1

IMPORTANT SAFETY INSTRUCTIONS

Read these instructions.

Keep these instructions.

Heed all warnings.

Follow all instructions.

Do not use this apparatus near water.

Clean only with a dry cloth.

Do not block any ventilation openings. Install in accordance with the manufacturer's instructions.

Do not install near any heat sources such as radiators, heat registers, stoves, or other apparatus (including amplifiers) that produce heat.

Do not defeat the safety purpose of a polarised or grounding type plug. A polarised plug has two blades with one wider than the other. A grounding type plug has two blades and a third grounding prong. The wide blade or the third prong are provided for your safety. If the provided plug does not fit into your outlet, consult only a Qualified and Approved Electrician for replacement of the obsolete outlet.

Protect the power cord from being walked on or pinched particularly at plugs, convenience receptacles and the point where they exit from the apparatus.

Only use attachments/accessories specified by the manufacturer.

Batteries (battery pack or batteries installed) shall not be exposed to excessive heat such as sunshine, fire or the like.

This apparatus may not be used as a Television set.



Use only with the cart, stand, tripod, bracket or table specified by the manufacturer, or sold with the apparatus. When a cart is used, use caution when moving the cart/apparatus combination to avoid injury from tip-over.

Unplug this apparatus during lightning storms or when unused for long periods of time.

Refer all servicing to qualified service personnel. Servicing is required when the apparatus has been damaged in any way, such as power-supply cord or plug is damaged, liquid has been spilled or objects fallen into the apparatus, the apparatus has been exposed to rain or moisture, does not operate normally, or has been dropped.

Note: It is recommended that all maintenance and service on the product should be carried out by Soundcraft or its authorised agents. Soundcraft cannot accept any liability whatsoever for any loss or damage caused by service, maintenance or repair by unauthorised personnel.



WARNING: To reduce the risk of fire or electric shock, do not expose this apparatus to rain or moisture.

Do not expose the apparatus to dripping or splashing and do not place objects filled with liquids, such as vases, on the apparatus.

No naked flame sources, such as lighted candles, should be placed on the apparatus.

Warning: Do not use this apparatus in very dusty atmospheres, or in atmospheres containing flammable gases or chemicals.

THIS APPARATUS MUST BE EARTHED. Under no circumstances should the safety earth be disconnected from the mains lead.

The mains supply disconnect device is the mains plug. It must remain accessible so as to be readily operable when the apparatus is in use.

If any part of the mains cord set is damaged, the complete cord set should be replaced. The following information is for reference only.

The wires in the mains lead are coloured in accordance with the following code:

Earth (Ground):	Green and Yellow (US - Green/Yellow)
Neutral:	Blue (US - White)
Live (Hot):	Brown (US - Black)

As the colours of the wires in the mains lead may not correspond with the coloured markings identifying the terminals in your plug, proceed as follows:

* The wire which is coloured Green and Yellow must be connected to the terminal in the plug which is marked with the letter E or by the earth symbol. 

* The wire which is coloured Blue must be connected to the terminal in the plug which is marked with the letter N

* The wire which is coloured Brown must be connected to the terminal in the plug which is marked with the letter L

Ensure that these colour codes are followed carefully in the event of the plug being changed

This unit is capable of operating over a range of mains voltages as marked on the rear panel.

NOTE: This equipment has been tested and found to comply with the limits for a Class A digital device, pursuant to Part 15 of the FCC Rules. These limits are designed to provide reasonable protection against harmful interference when the equipment is operated in a commercial environment. This equipment generates, uses and can radiate radio frequency energy and, if not installed and used in accordance with the instruction manual, may cause harmful interference to radio communications. Operation of this equipment in a residential area is likely to cause harmful interference in which case the user will be required to correct the interference at his own expense.

This Class A digital apparatus meets the requirements of the Canadian Interference-Causing Equipment Regulations. Cet appareil numérique de la Classe A respecte toutes les exigences du Règlement sur le matériel brouilleur du Canada.

SAFETY SYMBOL GUIDE

For your own safety and to avoid invalidation of the warranty all text marked with these symbols should be read carefully.



WARNINGS

The lightning flash with arrowhead symbol, is intended to alert the user to the presence of un-insulated “dangerous voltage” within the product’s enclosure that may be of sufficient magnitude to constitute a risk of electric shock to persons.



CAUTIONS

The exclamation point within an equilateral triangle is intended to alert the user to the presence of important operating and maintenance (servicing) instructions in the literature accompanying the appliance.



NOTES

Contain important information and useful tips on the operation of your equipment.



HEADPHONES SAFETY WARNING

Contain important information and useful tips on headphone outputs and monitoring levels.

INSTALLATION

General Precautions

Avoid storing or using the mixing console in conditions of excessive heat or cold, or in positions where it is likely to be subject to vibration, dust or moisture. Do not use any liquids to clean the fascia of the unit: a soft dry cloth is ideal.

Avoid using the console close to strong sources of electromagnetic radiation (e.g. video monitors, high-power electric cabling): this may cause degradation of the audio quality due to induced voltages in connecting leads and chassis.

Caution! In all cases, refer servicing to qualified personnel.

Handling and Transport

The console is supplied in a strong carton. If it is necessary to move it any distance after installation it is recommended that this packing is used to protect it. Be sure to disconnect all cabling before moving. If the console is to be regularly moved we recommend that it is installed in a foam lined flightcase. At all times avoid applying excessive force to any knobs, switches or connectors.

Power Cable

Always use the power supply cable supplied with the mixer: the use of alternative cables may cause damage and voids the warranty.

Warning! In the event of an electrical storm, or large mains voltage fluctuations, immediately switch off the mixer and unplug from the mains.

Signal Levels

It is important to supply the correct input levels to the console, otherwise signal to noise ratio or distortion performance may be degraded; and in extreme cases, damage to the internal) circuitry may result. Likewise, on all balanced inputs avoid sources with large common mode DC, AC or RF voltages, as these will reduce the available signal range on the inputs. Note that $0\text{dBu} = 0.775\text{V RMS}$.

Refer to the Specifications section for details of input and output levels.

MAINS INSTALLATION

General Wiring Procedures

To take full advantage of the excellent signal to noise ratio and low distortion of Soundcraft consoles, care must be taken to ensure that incorrect installation and wiring does not degrade the performance of the desk. Hum, buzz, instability and Radio Frequency interference can usually be traced to earth loops and inferior earthing systems. In some areas, especially heavily industrial areas, the incoming mains earth will not be adequate and a separate technical earth for all the audio equipment must be supplied. However, check with your local electricity supply company to ensure that safety regulations are not infringed or negated.

The successful, hum free, installation of a system requires forethought, and the establishment of a set of ground rules, which must be consistently adhered to at all stages of installation.

WORKING SAFELY WITH SOUND

Although your new console will not make any noise until you feed it signals, it has the capability to produce sounds which when monitored through a PA system or headphones can damage hearing over time. The table below is taken from the Occupational Safety & Health Administration directive on Occupational noise exposure (1926.52):

PERMISSABLE NOISE EXPOSURE

DURATION PER DAY, HOURS	SOUND LEVEL dBA SLOW RESPONSE
8	90
6	92
4	95
3	97
2	100
1.5	102
1	105
0.5	110
<0.25	115



Conforming to this directive will minimise the risk of hearing damage caused by long listening periods. A simple rule to follow is the longer you listen the lower the average volume should be.

Please take care when working with your audio - if you are manipulating controls which you don't understand (which we all do when we are learning), make sure your monitors are turned down. Remember that your ears are the most important tool of your trade, look after them, and they will look after you.

Most importantly - don't be afraid to experiment to find out how each parameter affects the sound - this will extend your creativity and help you to get the best results.

Recommended headphone impedance is 50-600 ohms.

WARRANTY

- 1 Soundcraft is a trading division of Harman International Industries Ltd.
End User means the person who first puts the equipment into regular operation.
Dealer means the person other than Soundcraft (if any) from whom the End User purchased the Equipment, provided such a person is authorised for this purpose by Soundcraft or its accredited Distributor.

Equipment means the equipment supplied with this manual.
- 2 If within the period of twelve months from the date of delivery of the Equipment to the End User it shall prove defective by reason only of faulty materials and/or workmanship to such an extent that the effectiveness and/or usability thereof is materially affected the Equipment or the defective component should be returned to the Dealer or to Soundcraft and subject to the following conditions the Dealer or Soundcraft will repair or replace the defective components. Any components replaced will become the property of Soundcraft.
- 3 Any Equipment or component returned will be at the risk of the End User whilst in transit (both to and from the Dealer or Soundcraft) and postage must be prepaid.
- 4 This warranty shall only be available if:
 - a) the Equipment has been properly installed in accordance with instructions contained in Soundcraft's manual; and
 - b) the End User has notified Soundcraft or the Dealer within 14 days of the defect appearing; and
 - c) no persons other than authorised representatives of Soundcraft or the Dealer have effected any replacement of parts maintenance adjustments or repairs to the Equipment; and
 - d) the End User has used the Equipment only for such purposes as Soundcraft recommends, with only such operating supplies as meet Soundcraft's specifications and otherwise in all respects in accordance Soundcraft's recommendations.
- 5 Defects arising as a result of the following are not covered by this Warranty: faulty or negligent handling, chemical or electro-chemical or electrical influences, accidental damage, Acts of God, neglect, deficiency in electrical power, air-conditioning or humidity control.
6. The benefit of this Warranty may not be assigned by the End User.
7. End Users who are consumers should note their rights under this Warranty are in addition to and do not affect any other rights to which they may be entitled against the seller of the Equipment.

Soundcraft Vi1™ FEATURES AND SPECIFICATIONS

Audio Channels

Max number of simultaneous mixing channels

64 mono inputs into 27 mix busses.

Pairs of mono inputs can be linked to create stereo channels.

Insert points

24 insert send/return pairs can be configured (using available I/O) and assigned to any of the 64 inputs or 27 output channels

Direct Outputs

All 32 input channels on the Vi1 can have direct outputs in addition to their internal bus routing, assuming sufficient I/O is available (eg via 64ch optical MADI card, see below)

Busses

24 Grp/Aux/Matrix*, plus main LCR Mix and LR Solo busses.

* a maximum of 8 matrix outputs can be configured.

I/O Capability

The following I/O is available and can be patched to any channel input, direct output, bus output or insert point as required:

Local Inputs

- 32 analogue mic/line inputs
- 1 Talkback Mic input (mounted on control surface)
- 2 pairs of AES/EBU inputs (=4 channels)
- 64ch MADI In via optical SC connectors via optional card

(Optional) Stagebox Inputs

- 32 analogue mic/line inputs (with remote gain control, PAD, 48V and pre-A-D 80Hz HPF)

Stagebox Outputs

- 32 analogue line outputs

Miscellaneous

GPIO facility

- 8 GPIO inputs and outputs on the stagebox (All outputs are relay contact closure)

MIDI

- 1 MIDI Input and 2 MIDI Outputs on rear of control surface.

Channel Processing

Inputs

- Analogue gain (remote control of stagebox or local mic preamp)
- Digital Gain Trim (+18/-36dB)
- Delay (0-100ms)
- HPF, LPF (variable 20-600Hz and 1-20kHz)
- 4-band fully parametric EQ, shelf mode on HF/LF.
- Compressor (variable threshold, attack, release, ratio, makeup gain with 'auto' mode)
- Limiter (variable threshold, attack, release)
- Gate or De-Esser. Gate switchable to ducker.
- Insert point for external processing.
- Pan - LR or LCR switchable.
- Direct Output, patchable to any I/O and with selectable tap-off point.

Outputs

- HPF (variable 20-600Hz)
- 4-band fully parametric EQ, shelf mode on HF/LF.
- Compressor
- Limiter
- Delay (0-1sec)
- Insert point for external processing.
- Pan (Output bus to LCR) - LR or LCR switchable.
- Bus Feed feature - allows switched routing of one bus to another.
- Graphic EQ 1/3-octave (with FX Card)
- Assignable Lexicon Multi-FX processors x8 (with FX Card)

Control Surface

Inputs

16 input faders, switchable in 4 fixed and 5 configurable layers to access 64 inputs

Widescreen Vistonics™ channel strip interface x controlling 16 input channels at a time.

Fader tray contains motorised faders, Mute, Solo, Isolate and F (user defined) switches, plus one assignable rotary encoder with LED display ring. This encoder is globally assignable to Gain, Pan, Gate Threshold, or one of 2 user-definable parameters.

Input level and gain reduction meters are located above each fader.

Input faders can be assigned to the 8 VCA (control group) masters and/or 4 Mute Groups.

Input faders can be switched to control all 24 Grp/Aux/Matrix Outputs, or can control an individual Aux send mix, using the switchable 'Follow Solo' function. Soundcraft FaderGlow™ clearly indicates using colours when faders are not controlling inputs.

Outputs

8 assignable Output faders, plus dedicated LR and C Master faders, plus 16 assignable rotary Output faders. Output faders are colour-coded using Soundcraft FaderGlow.

Output faders can be assigned to the 8 VCA (control group) masters and/or 4 Mute Groups.

Widescreen Vistonics™ interface for Output processing control, also functions as complete meter overview display for all Inputs & Outputs, plus snapshot Cue List and diagnostics info display.

Misc

Gang mode for temporary linking of any number of channels or outputs for quick adjustment and setup Controls for Mute Group and VCA Group assignment.

Controls for assignment of Vistonics™ rows to bus sends (when channel parameters are not assigned to Vistonics).

Snapshot automation controls.

Talkback & Oscillator controls.

Controls for Monitor Output level, phones level and Solo Trim and blend level.

CONSOLE OVERVIEW

Bays

The Desk is based on 1 input section and 1 Control bay:

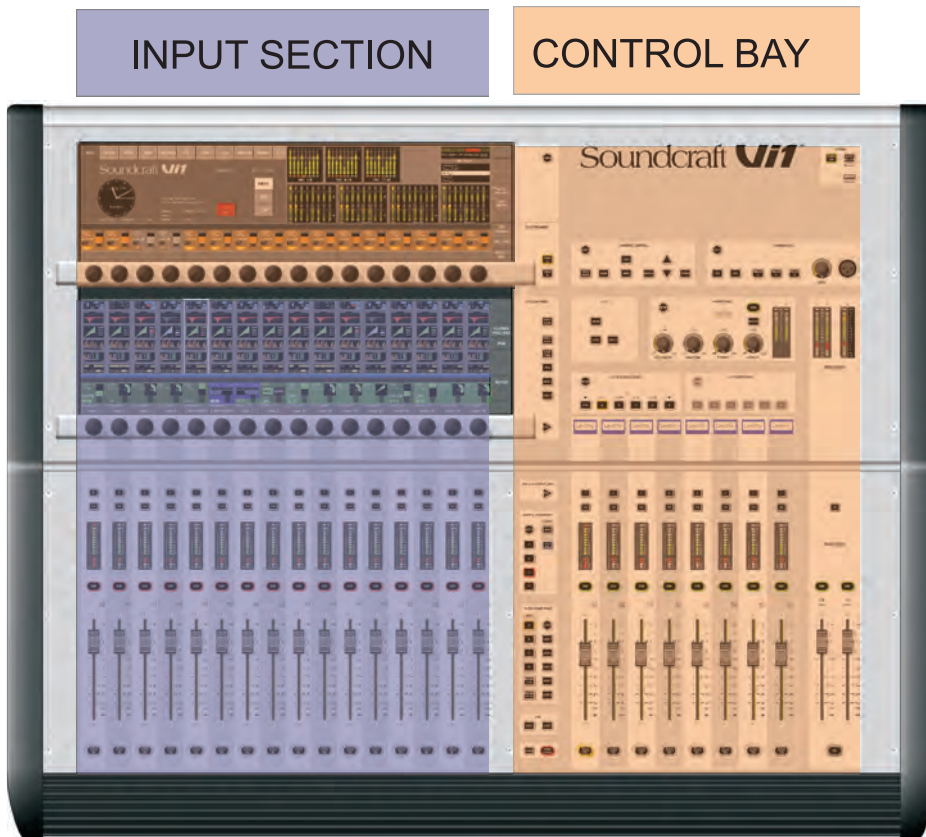

* The Input section contains 16 complete Fader strips with full state overview.

* The Master bay contains 8 Output Fader strips, the Masters and 16 Output encoders that give a total of 27 Output levels that can be directly controlled without changing Layers. General Functions like Snapshot, Monitoring, TB & OSC and so on are also located on the Master bay.

Layers

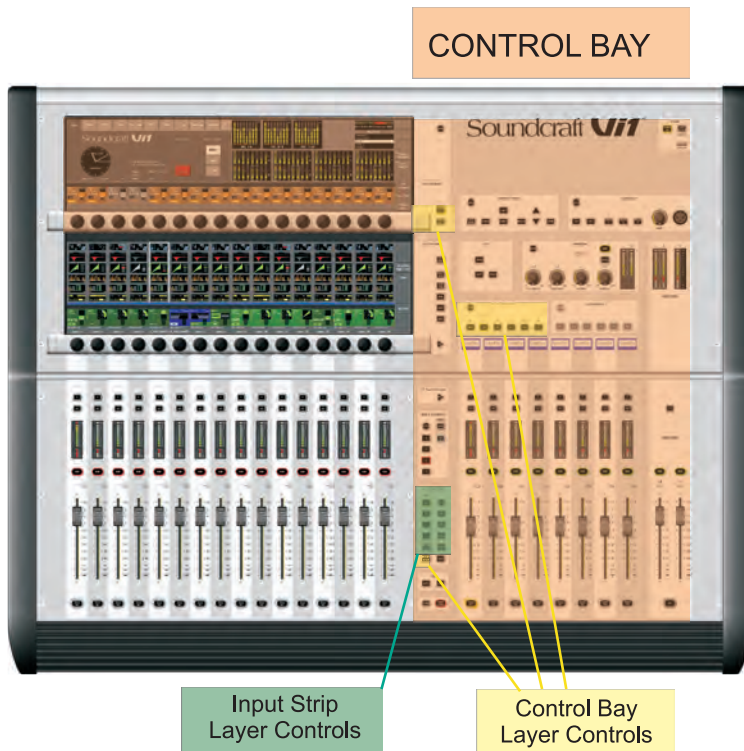

The console is able to control up to 64 inputs and 27 mix busses via its 16 input strips, 8 bus master strips and the LCR masters. To do this the console has a number of layers which the user accesses via the layer controls shown above.

Full details are given in chapter 8 of this manual.

Encoders

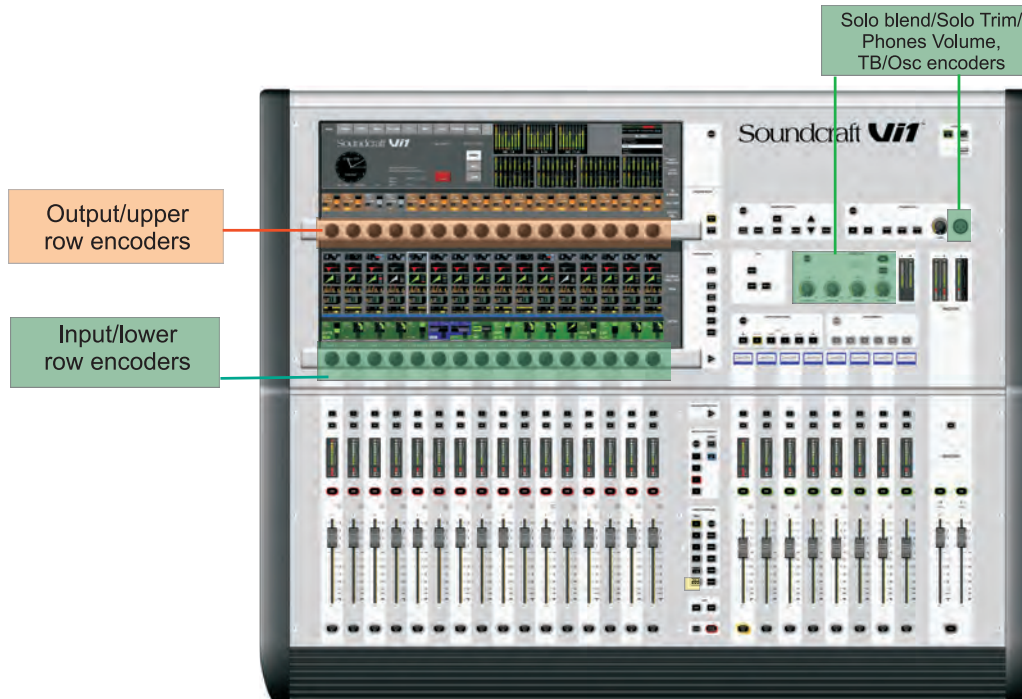

* The Widescreen Vistronics™ upper and lower **encoders**, are used in different modes, in which they can change in order to show various functions in a context-sensitive way.

* In normal operation they act as Input channel related controls.

* The **Channel encoders** are assigned with Input channel related functions.

* The **output encoders** are normally used as Output faders and are also context sensitive.

* There are four panel-mounted encoders with LED rings: the TB/OSC Level Control encoder, and the Solo Blend, Solo Trim & Phones Volume encoders. These are dedicated to their respective functions.

A detailed explanation of encoder use is given in chapter 7 of this manual.

Master Audio Functions

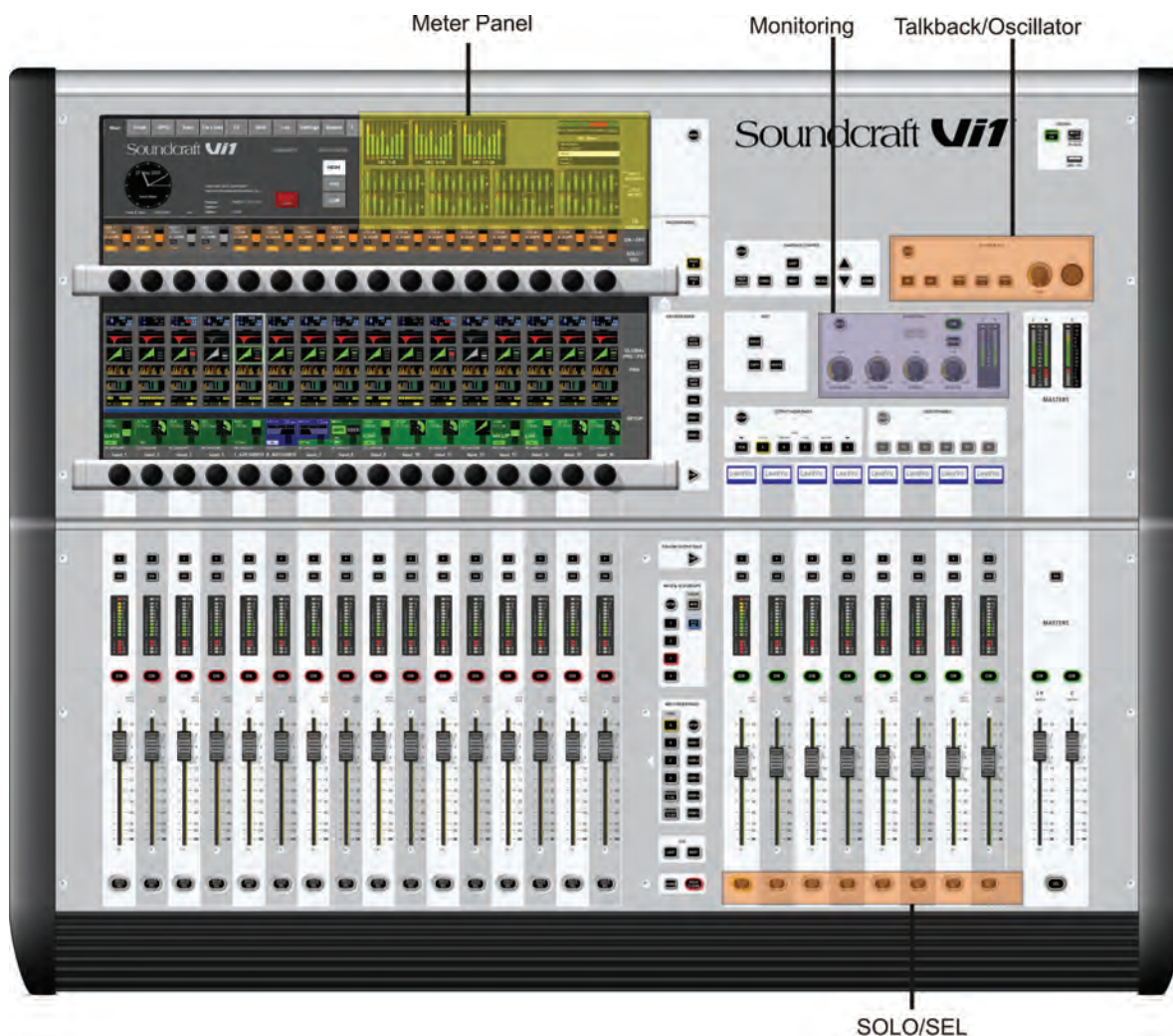

* The Monitoring system contains the functionality to listen to and monitor the audio signal at several points in the console.

* TB/OSC system contains the Talkback functionality and the oscillator settings.

* The Meter panel provides a full overview of all Input and Output levels.

Master Control

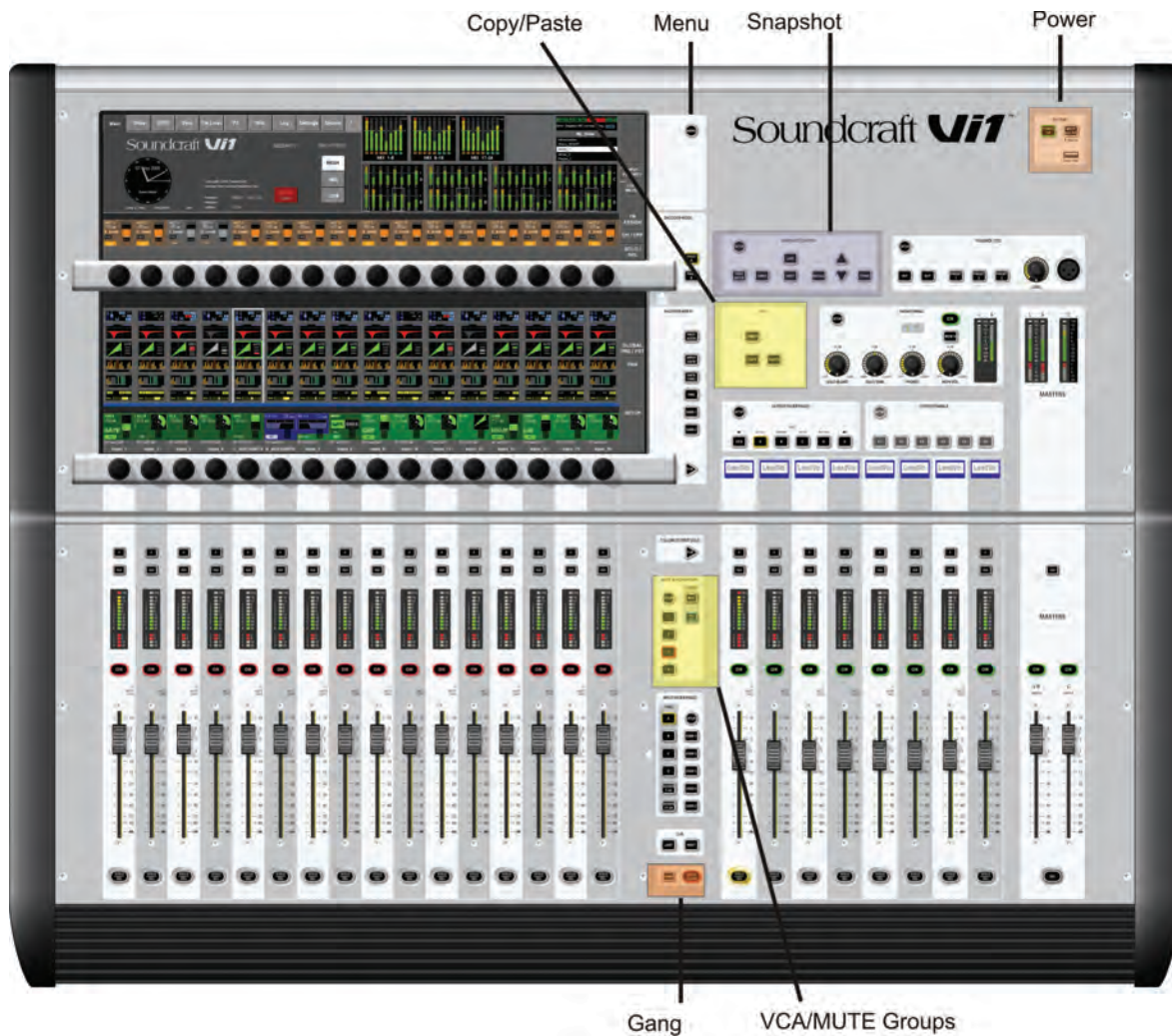

* VCA/Mute Groups: this functional block contains the VCA (control groups in VCA style) and Mute Group functions.

* Snapshot allows the console's automated settings to be saved and recalled.

* Menu opens the Menu page where central configurations can be done.

* Copy / paste functionality can be used in different modes and speeds up repetitive tasks..

* Gang is a superb feature that links channels functions together for temporary changes.

* [Power] switches the Desk on and off.

SYSTEM COMPONENTS

SYSTEM HARDWARE OVERVIEW - SOUNDCRAFT Vi1™

Control Surface with I/O

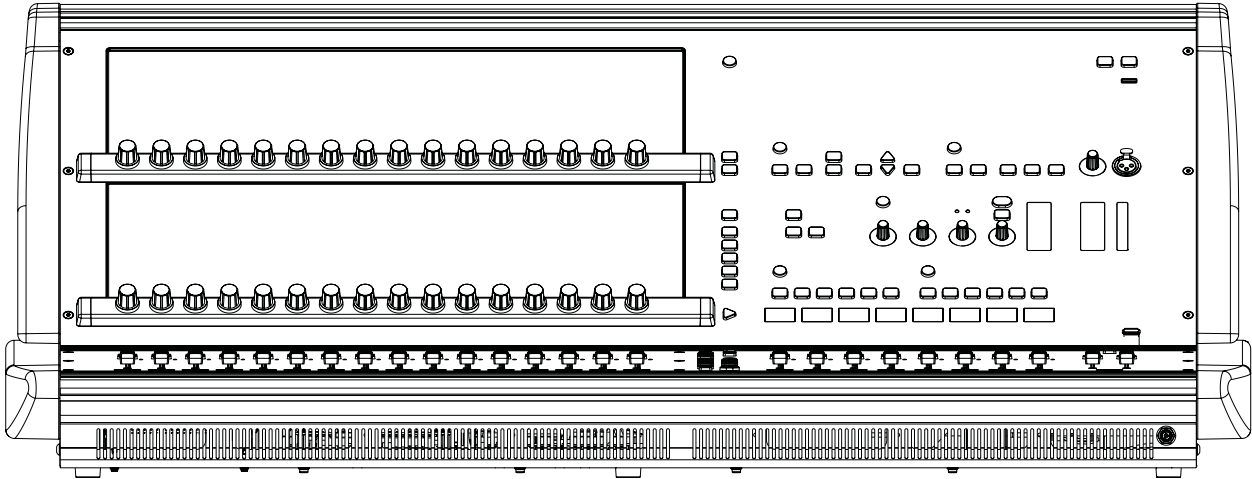

Optional Stage Box (Vi6 type)

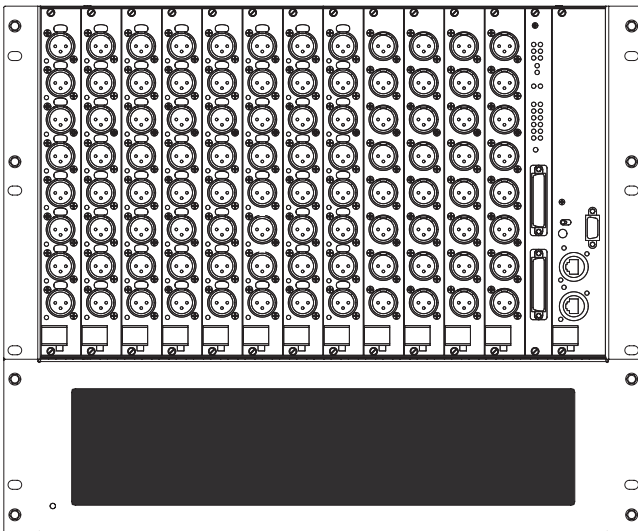

6U Stage Box

3U fan unit

Optional Stage Box (Compact type, planned availability October 2010)

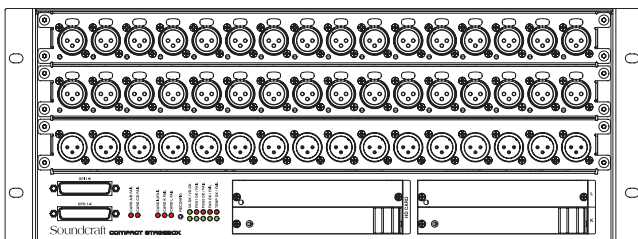

4U Stage Box

THE CONSOLE REAR CONNECTORS

(refer to picture on next page)

Mains Power Supply Inlet

The mains input is via an IEC connector, with an associated switch, as shown below. This feeds power to the primary PSU. A redundant primary supply is also fitted as standard. Its inlet connector is as shown below.

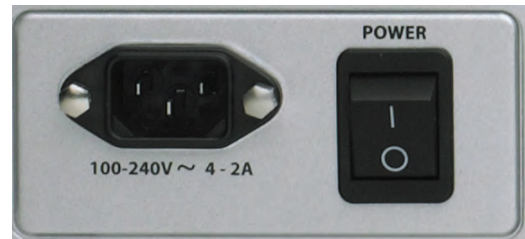
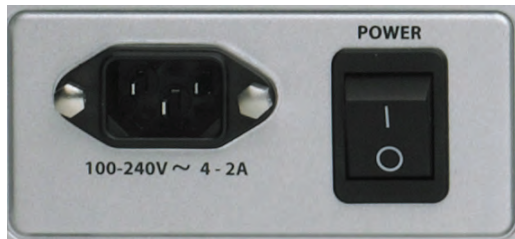

Audio And Data Connectors

Mic/Line Input XLR

These 32 XLR connectors are the primary audio inputs to the console.

AES/EBU input XLRs

There are 2 pairs (4 channels) of AES/EBU input on 2 XLRs.

S/PDIF Input

There is one RCA Phono socket for S/PDIF input (2 channels)

Line Output XLRs

There are 24 bus output XLRs (Group/Aux/Matrix), 3 Master output XLRs (L, R, C) and 2 sets of 3 connectors for the Monitor A (L, R, C) and Monitor B (L, R) outputs.

AES/EBU output XLRs

There are 2 pairs (4 channels) of AES/EBU output on 2 XLRs.

S/PDIF Output

There is one RCA Phono socket for S/PDIF input (2 channels)

MIDI Connectors

These are provided by the usual 5-pin DIN connectors for MIDI IN and MIDI OUT.

USB Connectors

There are 2 USB connectors for connecting external keyboards, mice or external storage devices.

HiQNet™ Connector

This is an XLR-housed EtherCon connector.

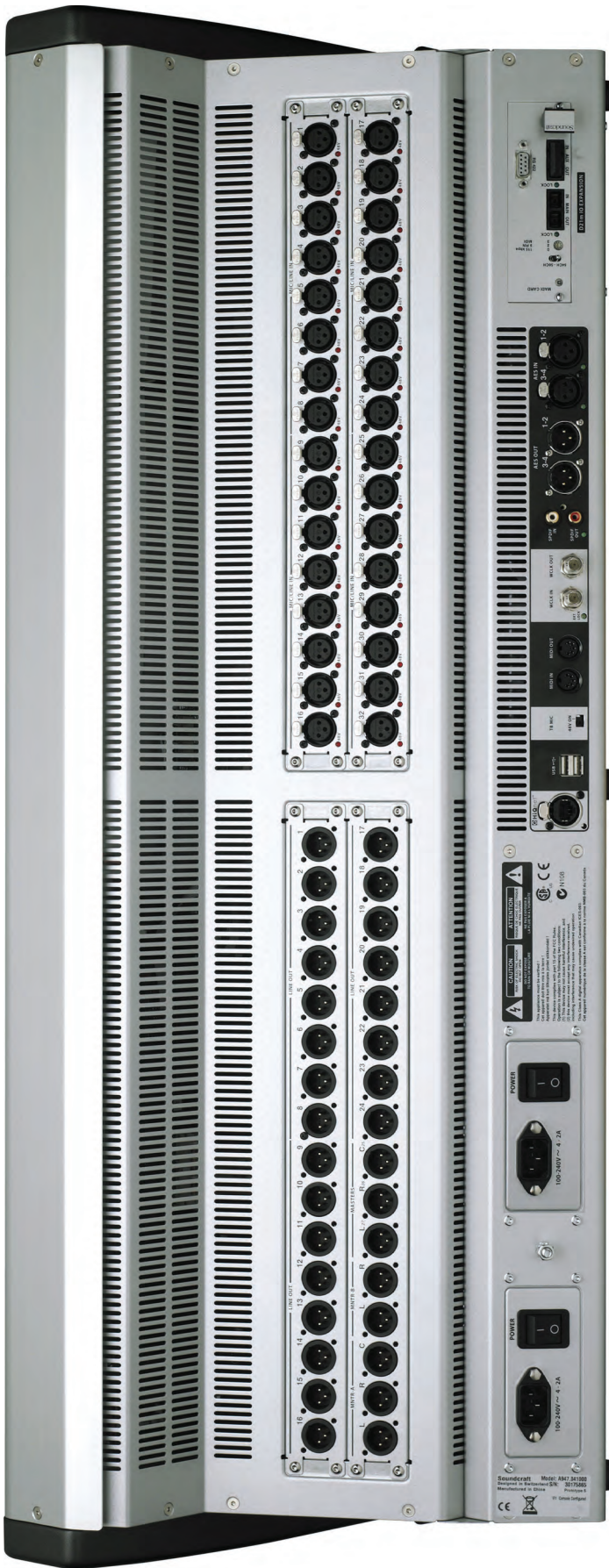

Console Rearcon Panel.

STAGE BOX (OPTIONAL EXPANSION WITH MADI CARD)

The optional Stage Box requires the addition of a standard D21m MADI card to the Vi1 option card slot, and contains 12 Slots for 6U-high Audio I/O Cards, a GPIO/LED Card and the MADI HD Card which contains the Stage Box-to-Console connection.

Slots are labelled from left to right A-L, and the connectors on the cards are numbered from top to bottom 1-8. These labelling references are used by the patching system (see chapter 11) when the user wishes to patch the connectors to input channels or output busses.

The primary power supplies and the ventilation monitoring connector can be found on the rear panel.

Stage Box Description

Primary power supply

The primary power supply connects directly to the IEC inlet and provides a full range ac inlet, converting 100V to 240V ac to 24V dc. The Stage box is normally fitted with two power supplies, providing redundancy for those that require it.

Audio I/O Cards

The following cards are supported.

- 6 X Mic/Line Input cards each providing eight electronically balanced Mic/Line Input channels, each with digitally-controlled analogue gain, a 20dB pad, a 80Hz low-cut filter, and phantom power.

- 3 X Line Output cards, each providing eight line output channels.

Optional Cards

- AES Input card, providing 8 AES input channels (replaces 1 Mic/Line Input card).

- AES Output card, providing 8 AES output channels (replaces 1 Mic/Line Output card).

- Aviom® card providing 16 output channels in A-Net16 format

- CobraNet® card providing 32-in and 32-out channels to a CobraNet® network.

- EtherSound® card providing up to 64 in and 64 out channels to an EtherSound® network.

Card Function Overview

Input card

Input cards handle 8 x mic amp, phantom power, pad, analogue low pass filter, phase reverse and A to D. The card has an internal ID, which indicates whether it is input or output and analogue or digital. This means that the system can automatically recognise if the card configuration has been changed.

Output Card

Output cards handle 8 x D to A. The card has a set of relays, which will mute the outputs if the power fails. The module type is identified by the internal ID of the module.

Normally 3 output cards are fitted, giving 24 outputs, however, more cards, up to a maximum of 8 cards giving 64 outputs, can be fitted if input cards are removed.

LED/GPIO/Status card.

Handles GPIO, which is controlled remotely from the Control Surface. The inputs are on opto-isolators and the outputs are relay contacts. The card also has status indicators for power rails, clock status and IO, and a RECONFIG button which must be pressed if the card configuration has been changed.

MADI HD link card

This card provides audio and control connection with the Vi1 console via MADI. The corresponding MADI card in the console transmits the clock for the Stagebox down the MADI stream. The second input on the card can be used to provide a redundant connection to the console or to connect to a second system if two consoles are to be used for a monitor/FOH configuration. The MADI card indicates its clock status using the lock LED on the card. An RS422 link output is also fitted, allowing RS422 data to be transmitted via a 'pipeline' within the MADI stream from a corresponding port on console's MADI card to allow remote RS422 control.



For single cable operation: the switch must be set to either 'MAIN' or 'AUX', depending on which socket is being used.

For Redundant operation with two cables, the switch must be set to 'RED' mode.

Front Panel

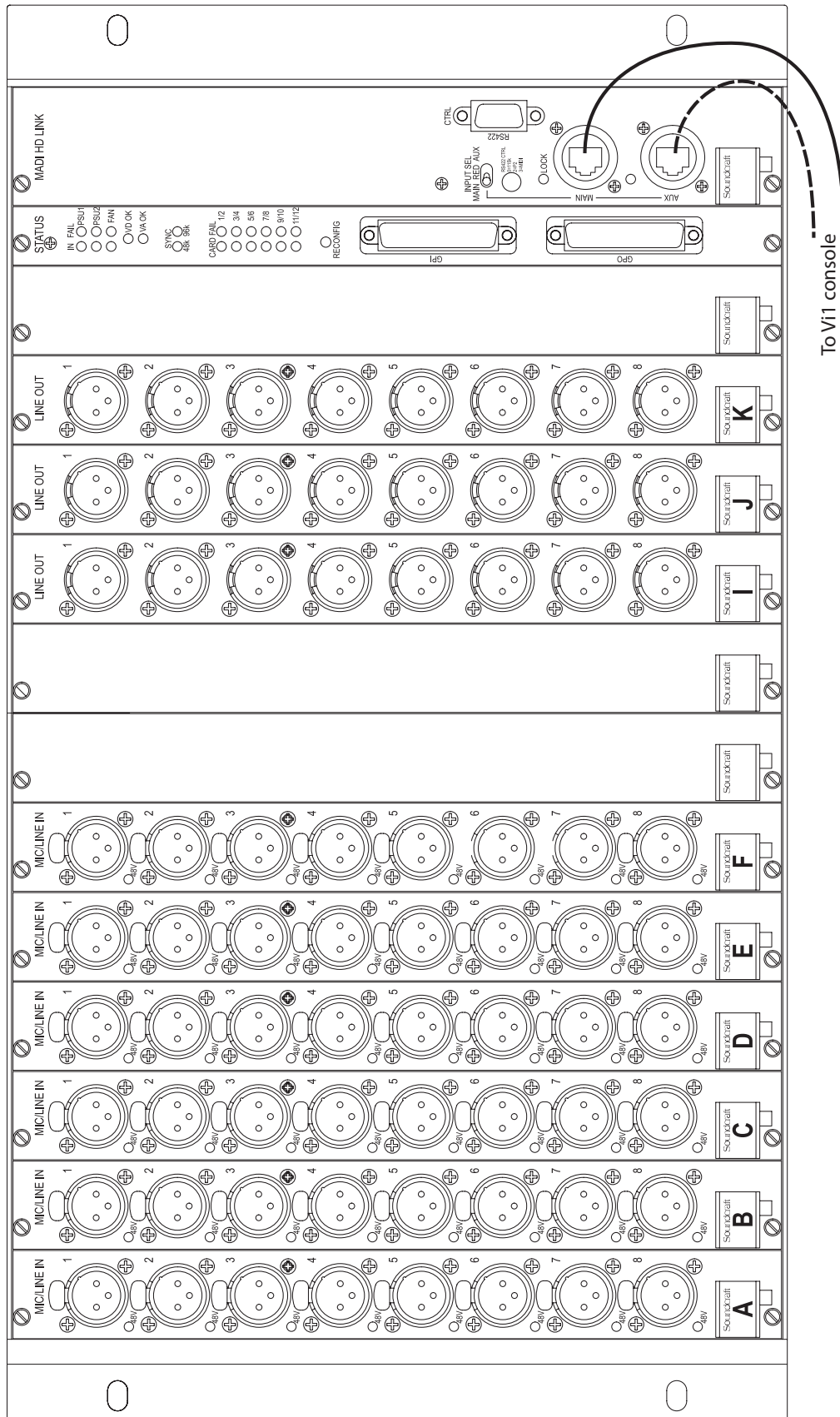

Optional Stage Box (Vi6 type) Front Panel.

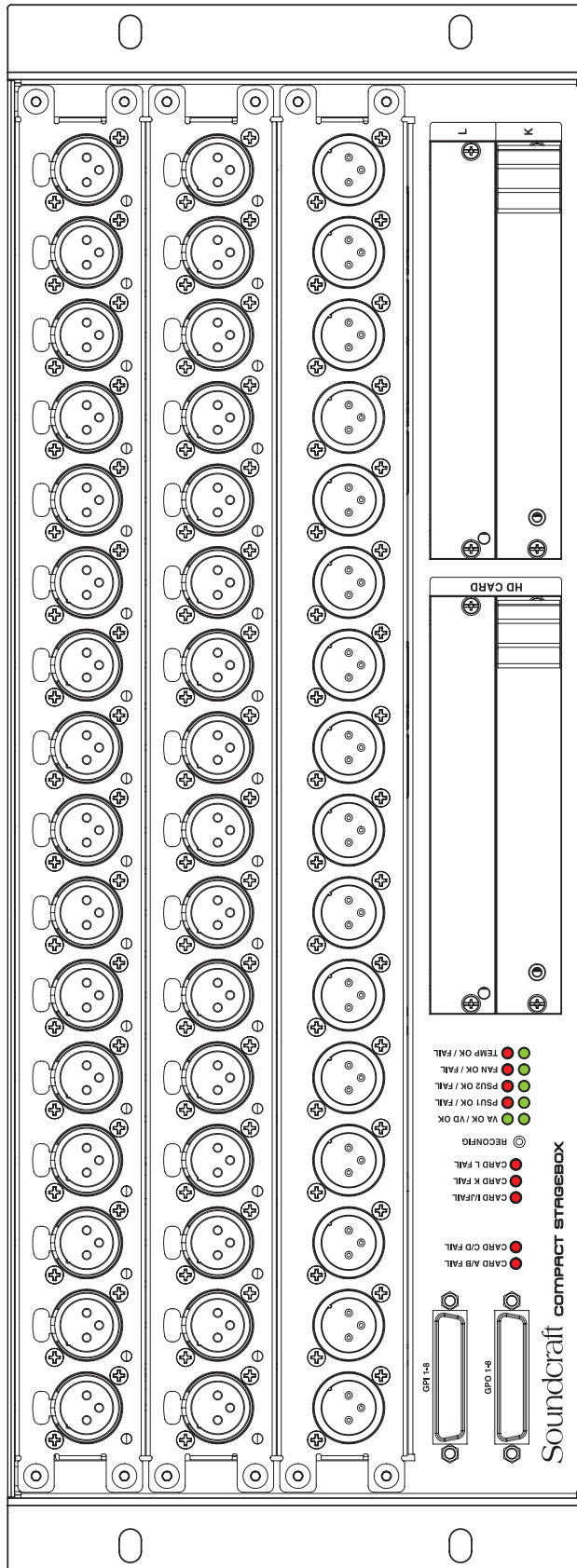

Optional Stage Box (Compact type) Front Panel.

Planned availability October 2010

OPERATION OVERVIEW

GENERAL RULES

- * Pressing a [SETUP] key whilst in that SETUP function will exit that function immediately.
- * Vistonics™ {EXIT} buttons close the page immediately.
- * Parameter changes made by the user are processed immediately.
- * Grey-out is used to show that an audio function block is bypassed.
- * In order to allow the pre-setting of parameters it is possible to change the parameters and states even if the block is greyed out, e.g. EQ filters can be switched on/off and parameters can be changed even if the Equaliser is switched off with the EQ {IN} key.

CONVENTIONS USED IN THIS MANUAL

Three types of brackets are used to indicate the type of control being referred to.

[] is used to indicate a panel-mounted key or encoder.

{ } is used to indicate an on-screen button associated with a Vistonics™ rotary control.

< > is used to indicate a button on a touch-screen.

SCREENS

Input Screens

The screen is divided into logical areas and fields as shown below.

System control

Output (Masters) section

VST Area

Input touch-field

EQ touch-field

Dynamics touch-field

Bus 1 to 16

Bus 17-24

Pan and Insert

VST Area

Label area



Figure 3-1: Main Screen Areas and Fields.

Further details about these areas and fields can be found in chapter 4.

Screen Colour Codes

The following table shows the colours used in their corresponding context:

Function	Colour
Audio Processing	
Input Functions	Blue
Equaliser	Red
Filter	Dark Blue
Gate,Comp,Lim,De-ess	Green
Pan, Dir Out, Insert	Yellow
Oscillator	Gold
Monitoring	Lilac
Busses	
Aux	Orange
Audio Group	Green
Matrix	Cyan
VCA/MG Indication	
VCA 1..8	Blue
Mute Group Patch	Red
Input Patch	Blue
Output Patch	Red
Control	Grey

For the Soundcraft FaderGlow™ colours see chapter 18. Soundcraft FaderGlow™ (Pat. Pend.) is a unique feature that gives the user an additional level of status overview, and can significantly reduce operating errors.

WIDESCREEN VISTONICS™ KNOBS

The state of the on-screen button is changed by touching the screen anywhere in the area of the displayed control.

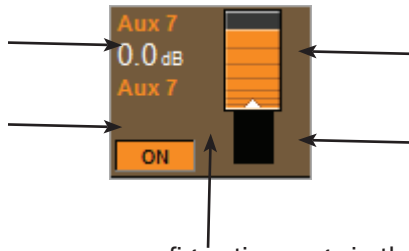

If the button can open a configuration page in the Touch area it looks like this:

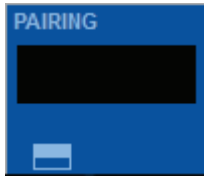

Normal



Page is open

AUDIO FUNCTION STATES

If an audio function block is disabled, with the background of the field changed to grey, the button indication will change to a darker colour.



MOMENTARY/LATCHING CONTROL ACTION

The physical keys on the desk have both a momentary and a latching action. If a key is pressed and released within approximately one half of a second, the control will latch. If the key is held down for longer, and then released, the control will return to its original state as the key is released.

The keys on the Vistonics area also operate in the same way.

The touch-screen buttons/areas operate in a latching mode only.

SOLO/SEL KEYS



The [SOLO/SEL] keys operate in two modes.

The default function is to enable the SOLO path from its channel or bus to the monitoring system.

However, if a touch-area page is open, pressing a [SOLO/SEL] from another channel (within its own bay of eight channels) moves the touch-area page to this new channel.

LABELLING

General

Labelling can be done with the on-screen keyboard or an external USB keyboard.

The on-screen keyboard is context sensitive and shows only the allowed character and symbols.

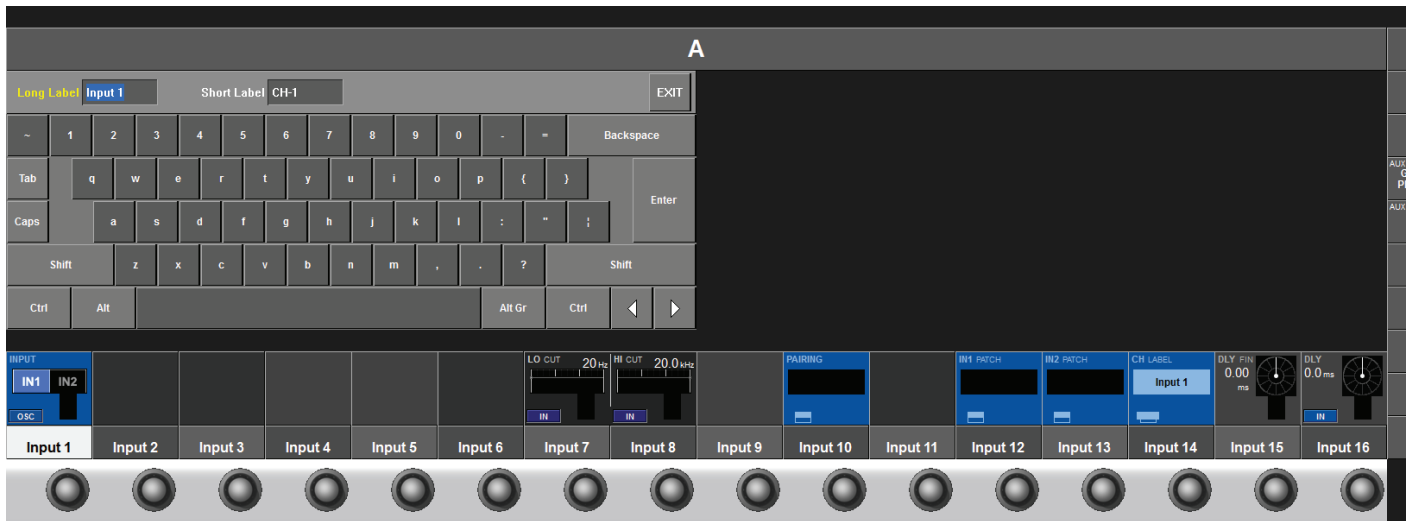

Fig 3-3: The On-screen Keyboard.

Channel Labels

By default the channels are labelled CH-1 to CH-32.

The Soundcraft Vi1™ uses long labels for the Screens and short labels for the LCDs. Long labels can contain up to 10 characters, whereas short labels are restricted to 6 characters.



The Channel Label Page.

Changing The Channel Label

- * Press the <INPUT> touch field to open the Input Page.
- * Enter the channel label page by pressing {CH LABEL} on the Input Page.
- * Type the long name (only valid characters are possible).
- * Adjust the short name if necessary by touching the <Short Label> on the screen or by using <TAB>.
- * Leave the page with <ENTER>, or by pressing {CH LABEL} again.

<TAB> toggles the cursor between long and short fields.



NOTE: On the Vi1, the short label is not displayed anywhere on the control surface, but is used to label some touchscreen buttons (e.g. in the user-defined fader page setup screens).

BUS CONFIGURATION

The most important configuration of the Soundcraft Vi1™ is the bus configuration, and this is done using the [ALL BUSSES] view on the input bays.

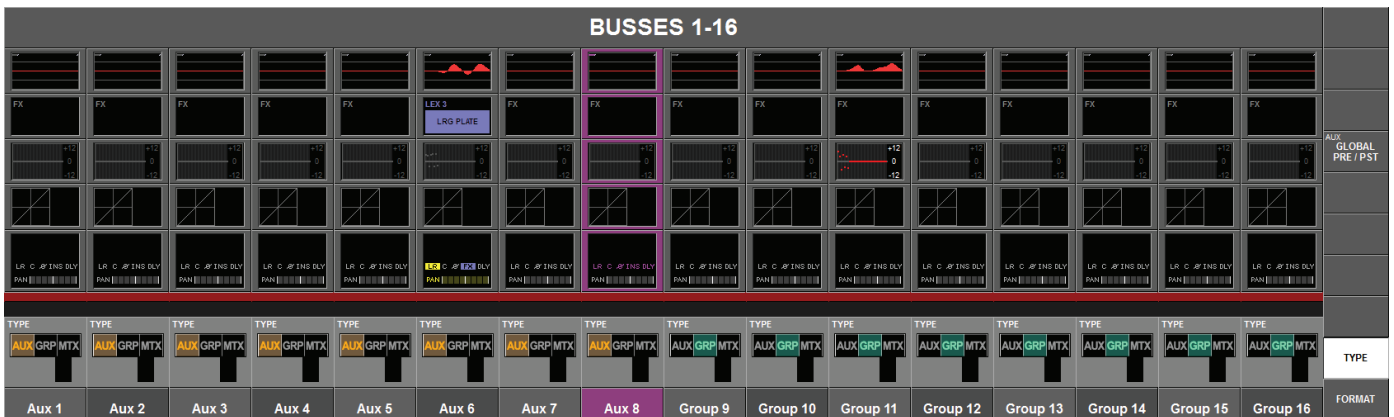

The TYPE field can be set to one of three values: AUX, GRP or MTX, the encoder is used to change the Bus Type. If Aux is selected and if the format field, see below, is set to stereo then the {CHPAN} field enables the stereo Aux send signal to follow channel pan, rather than have its own pan control.

The FORMAT field (only odd busses) is available for Aux and Grp busses and is accessed by pressing the FORMAT button on the far right of the screen.

The field can be set to Mono or Stereo. The Encoder changes the setting of the Audio Format field. If the field is set to stereo the next even numbered bus will not be shown.

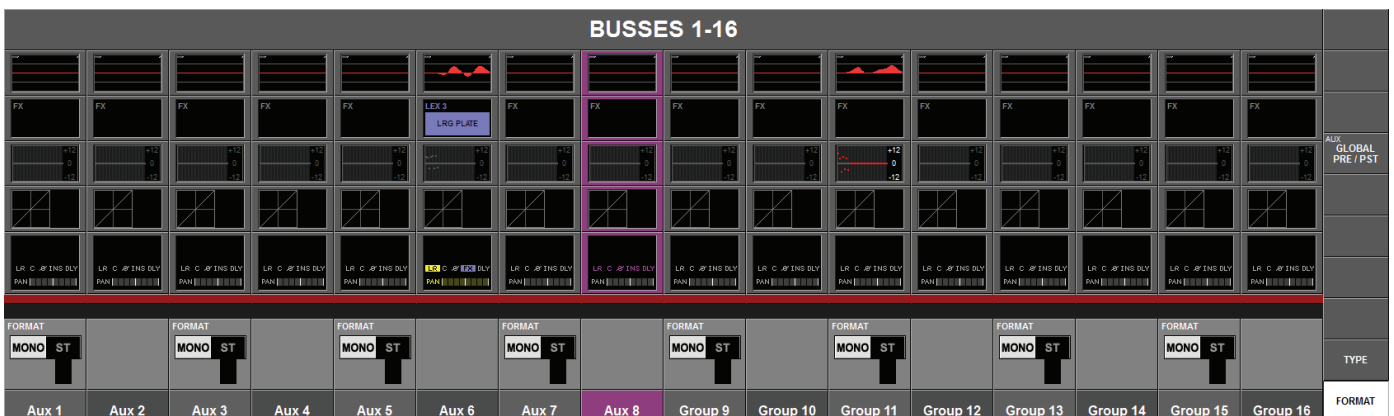

In the ALL BUSSES Layer, all 24 Busses are shown from left to right on the four input bays. i.e., Bus 1 is mapped to the left-most strip, while bus 24 is mapped to the right-most strip of the Control Surface.

The Vi1 supports the following Bus Types:

- AUX Mono
- AUX Stereo
- Group Mono
- Group Stereo
- Matrix Mono

GANG

General

Gang is a very helpful feature to speed up operations that influence functions on multiple input channels, or on output busses, in the same way.

For example, if Input Channels are ganged, then a parameter change of a function will be applied to all other ganged channels in an offset manner. For example, adjusting any rotary parameter or fader within a gang will add that offset to, or subtract it from, all other channels in the gang. Pressing a switch will change all other channels whose switches are not currently in the resulting state, to that state. From that point on, further presses will result in all switches changing mode together.

Creating A Gang

- * Activate the GANG Mode with [GANG], the [GANG] key will glow blue (see Figure 1-4 for the location of the [GANG] key).
- * Add/remove a channel by pressing channel's [SOLO/SEL] key. The [SOLO/SEL] becomes blue if the channel is in the gang.
- * ADD/Remove a range by pressing the first and last channel [SOLO/SEL] together.

Switching-Off Gang Mode

Once a Gang has been created, it can be de-activated by switching the [GANG] key off. The [SOLO/SEL] keys will return to normal solo operation. The Gang will be stored however, and can be re-activated for further use at any time. Gang member settings are independent of the console's snapshot automation, but are stored when the console is powered off.

Clearing A Gang

- * Press and hold any active (blue) [SOLO/SEL]
or
- * Leave the GANG mode with [GANG].

Gang All Input Channels

- * Press and release [GANG] to switch Gang mode on, and then press and hold [GANG] until all of the Input [SOLO/SEL] keys turn blue. This selects all channels (including hidden layers) to the gang. When all of the Inputs are Ganged their [SOLO/SEL] keys turn blue.



NOTE: Entering Gang Mode does not cancel any solos of any type that are active at the time. The Solo system continues to work as it was when Gang Mode was switched ON. The amber 'Solo' illumination of the Solo/Sel switches cannot be seen whilst gang mode is ON.



NOTE: It is recommended that Gangs are cleared down after use, particularly if GANG ALL is used.

INPUT

SIGNAL FLOW

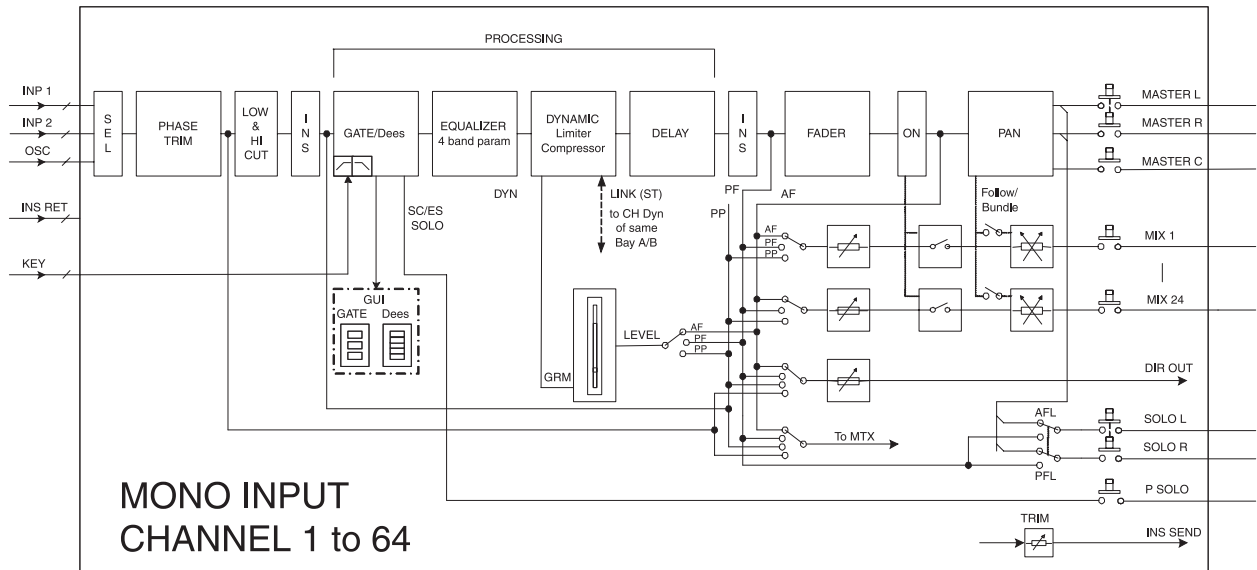

Only one of the two insert points can be used per channel at any time.

INPUT CHANNEL STRIP

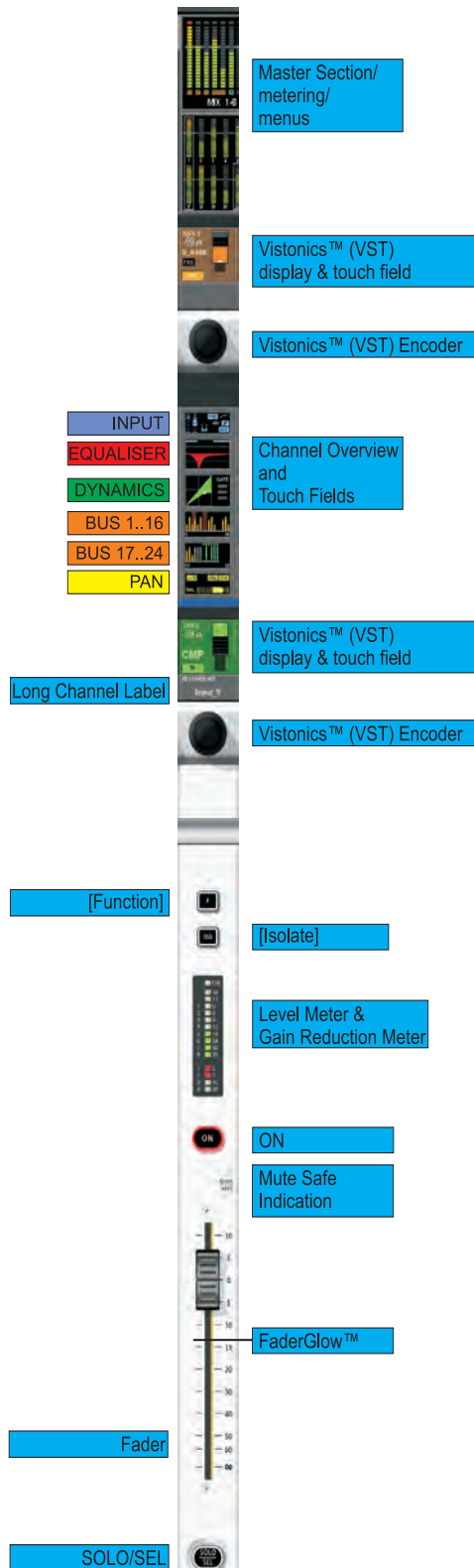

The Level Meter reads from -36dB to +18db, The GRM (Gain Reduction Meter) reads from -2 to -20dB.

INPUT CHANNEL TOUCH FIELDS

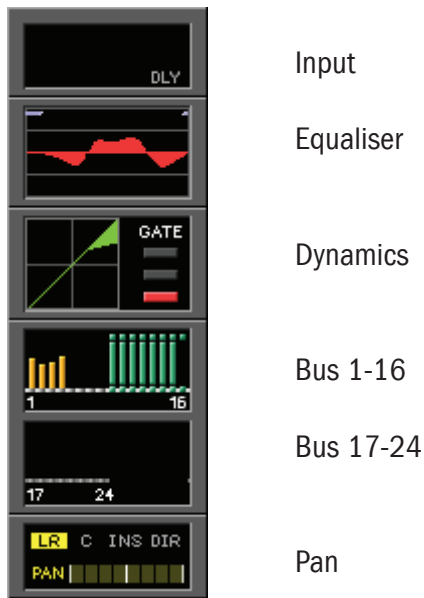

Change A Parameter Of An Input Channel

- * Press the desired touch field, the corresponding VST area will open,
- * change the parameter.
- * Press the touch field again to go back the default VST view OR
- * Press another touch field.

INPUT

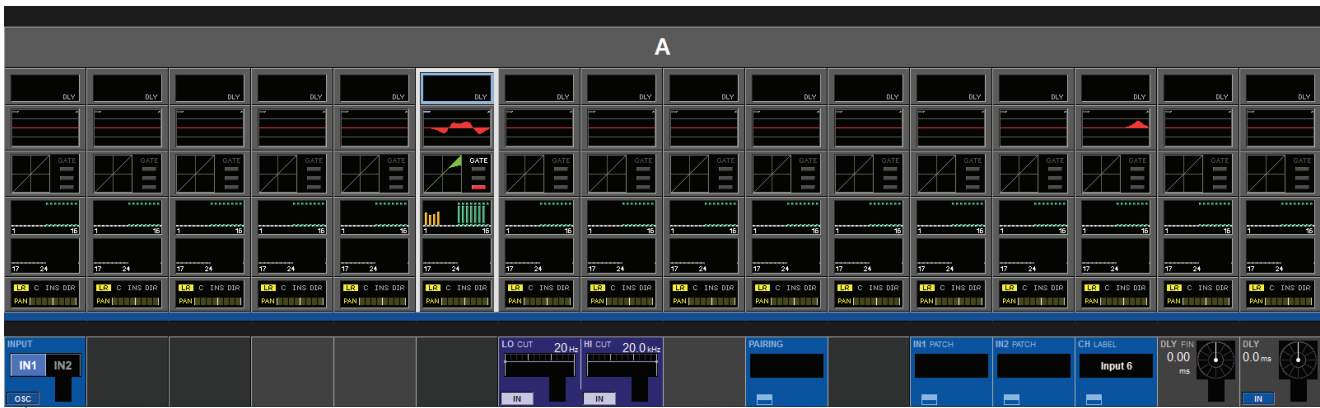

INPUT field

Select source IN1 or IN2. If OSC is active the central oscillator is patched to this channel and the selector is disabled.

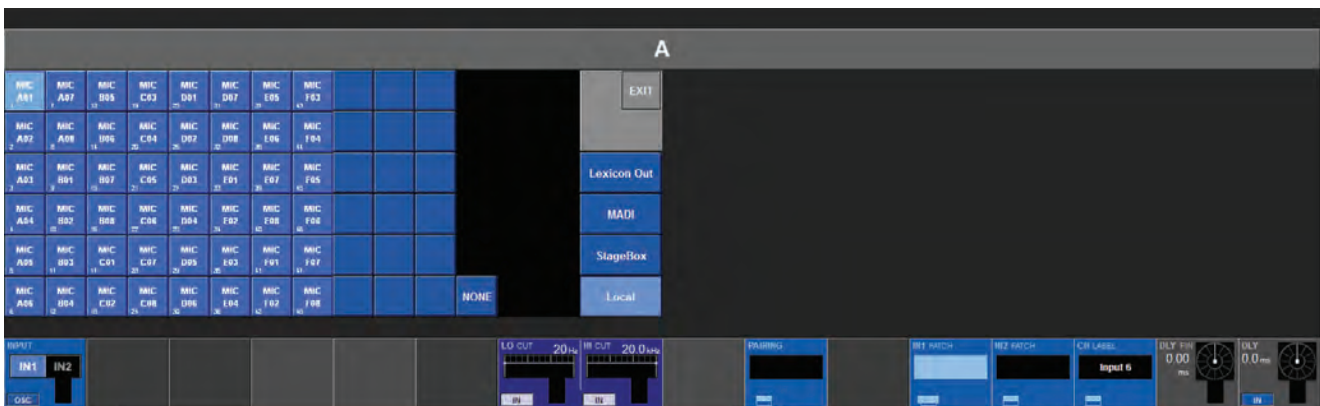

Pressing the {IN1 PATCH} or {IN2 PATCH} VST config key opens the Input Patch Configuration page.

GAIN field

{encoder} adjusts the analogue input gain in the range from +5 dB to +65 dB. {PAD} reduces the input sensitivity by 20 dB.



Note: If a Vi6 type Stagebox is attached, the gain range will be +15dB to +60dB and will have a 20dB PAD switch.

TRIM field

Encoder adjusts the digital Input Gain in the range +18/-36 dB

{LO CUT} inserts the pre AD converter analogue low cut filter (Vi6 Stagebox inputs only).

LO CUT field

Encoder adjusts the Low cut frequency in the range 20 to 600 Hz.

{IN} switches the Low Cut filter in and out.

HI CUT field

Encoder adjusts the High cut frequency in the range 1k to 20kHz.
{IN} switches the Hi Cut filter in and out.

FORMAT field

If the Channel is paired, the Encoder adjusts the Stereo format, which can be:
LR / RL / LL / RR / MONO.
If the channel is not paired, this field is not displayed.

PAIRING field

If the Channel is paired the label of the paired channel is visible.
{Its VST config button} enters the pairing configuration.

PHANTOM field

{48V} enables the Phantom Power (+ 48 V) for the XLR patched to this input.

PHASE field

{INV} inverts the phase of this channel (180 Degrees).

IN1 PATCH field

Displays the source name that is patched to IN1.
{Its VST config button} opens the IN1 patch page (see chapter 10).

IN2 PATCH field

Displays the Source name that is patched to IN2.
{Its VST config button} opens the IN2 patch page (see chapter 10).

CH Label field

Displays the channel label.
{Its VST config button} opens the channel label configuration page (on-screen keyboard).

DLY field

Encoder changes the input delay in the range 0.. 100 mS.
{IN} enables the delay function.

DLY FIN field

This allows fine adjustment of the input delay in steps of 0.02mS

STEREO CONFIGURATION

Pairing of input channels

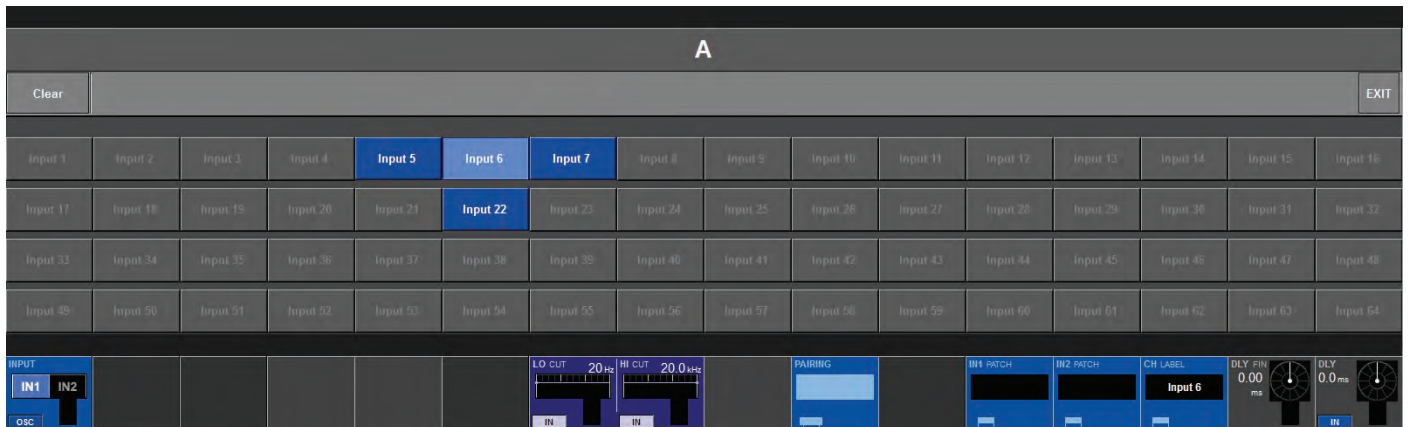

The available channels on the four fixed Layers A, B, C and D are displayed on the touch screen.

Pairing candidates are the unused left and right neighbours and the vertical neighbour on the adjacent layer. Existing Pairings will be shown greyed out. It is not possible to pair channels between layers B & C.

HINT: Selecting an input channel [SOLO/SEL] and or changing input layers moves this page to the desired channel without having to exit the page.

Pair An input Channel

- * Enter the pairing page by pressing {PAIRING} in the Input Page, all possible pairing candidates will be shown.
- * Select the desired pairing candidate, all channel parameters will be copied to the pairing candidate, links will be set. The meter overview in the Master screen shows the pairing information using white rectangles around the paired meters.
- * Leave the page with {EXIT} or {PAIRING}.

HINT: If you want to pair a channel with one that is already used in another pair, you must first release that pairing.

Linked Parameters on Paired Channels

In general, most parameters are linked between the two paired channels. the following parameters, however, are not linked:

GAIN, TRIM, 48V, PHASE, DELAY, INPUT PATCH, DIRECT OUT PATCH, PAN

EQUALISER

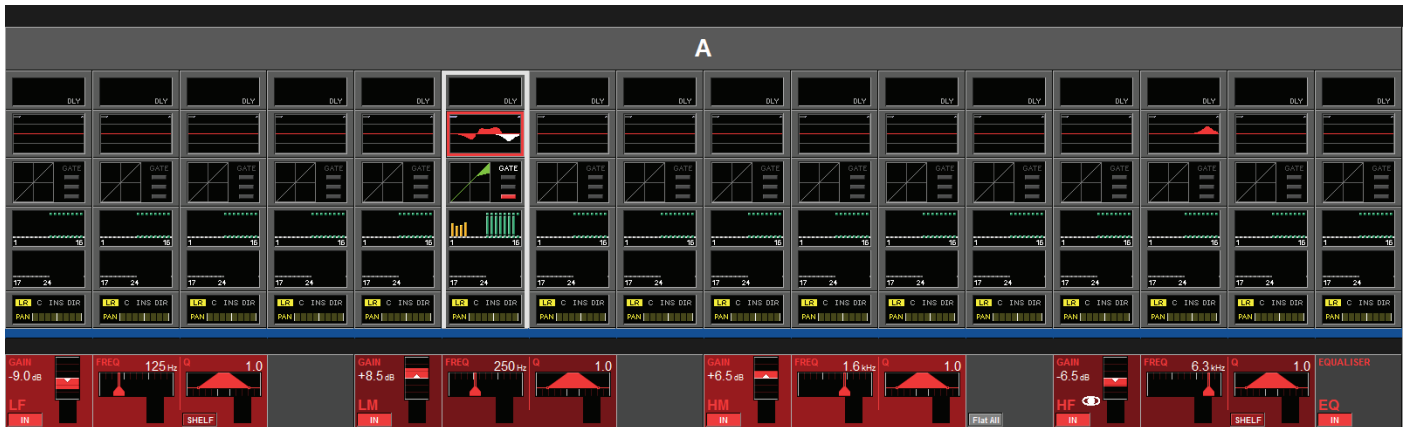

General

The Equaliser contains 4 full parametric Bands. All four parametric Equaliser Bands operates over the full frequency range. The characteristics of the LF and HF bands can also be set to SHELF mode.

The red Equaliser Graph in the Equaliser touch field represents the overall frequency curve.

Additionally, two blue bars at the top of the Equaliser touch field clearly indicate the Low and High Cut filter frequencies. (The filters are adjusted from within the INPUT Vistonics page.)

Equaliser Band Highlight

If you adjust one or more parameter encoders, the corresponding Equaliser band(s) will be indicated by the red overall graph being overwritten with a white graph that represents only the adjusted band(s). This is useful for identifying which part of a curve is associated with which EQ bands. The representation will return to the default when you leave the page.

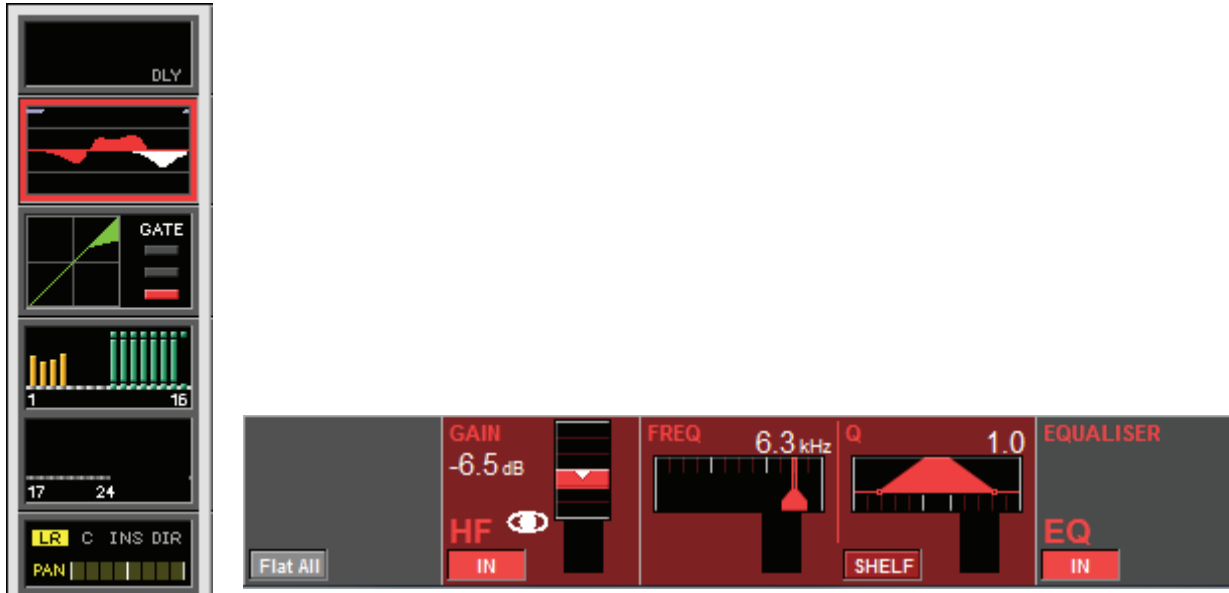

BAND Field

FLAT ALL switch

The {FLAT ALL} resets all four bands GAIN parameters to 0dB. the switch has to be pressed and held for 1 second to activate.

All four bands contain a GAIN, FREQ, Q encoder and an IN switch.

GAIN

Encoder adjusts the Gain in the range +/- 18 dB. {IN} enables the Equaliser band.

FREQ

Encoder adjusts the frequency in the range 20 Hz .. 20 kHz.

Q

Encoder adjusts the Q (Width) in the range 0.7 .. 15 only for BELL Mode.

IN Switch

{IN} enables this Equaliser band.

SHELF Switch

{SHELF} changes the response characteristic to SHELF. (12dB/oct) (HF/LF only)

EQUALISER Field

{IN} enables the full Equaliser section (without filters). For preparation, all Parameters including the band IN switches can be set, even if the Equaliser is switched off.

DYNAMICS

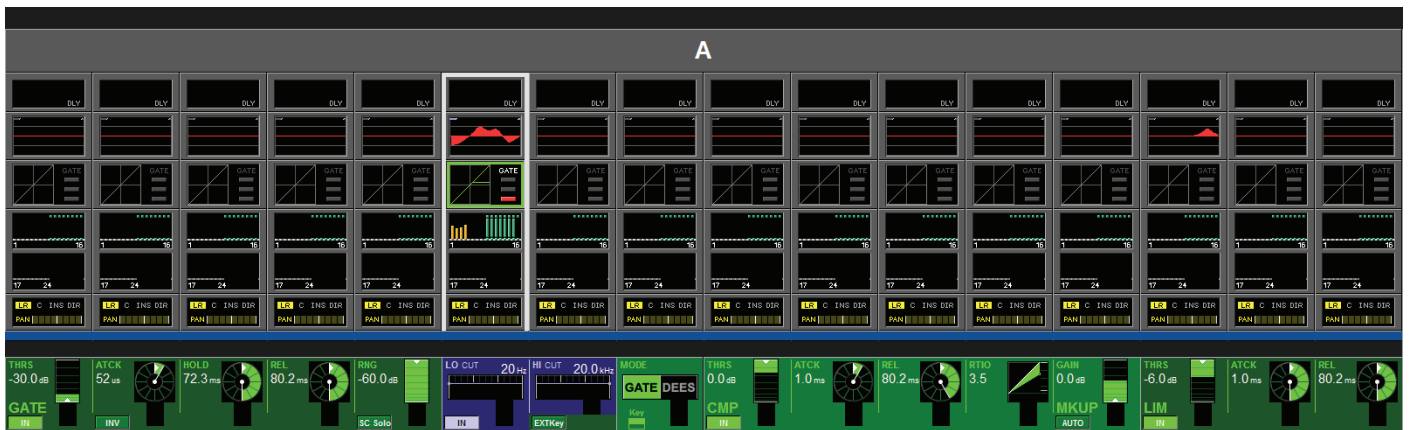

General

The Dynamics section contains a GATE with key filter, a Compressor and a Limiter. Alternatively the Gate can be set to operate in De-esser mode.

GATE Function

The Gate contains a side-chain input with filters, a Key listen SOLO and it can also operate in ducking mode.

State Indication

The Gate status is indicated on the right side of the Dynamics touch field:

- * ON green
- * HOLD yellow
- * OFF red

THRS Field

Encoder adjusts the threshold value between -40 db to +18db.
{IN} enables the GATE.

ATCK field

Encoder adjusts the attack time in the range 10μS to 957mS.
{INV} sets the GATE to inverse mode (ducking mode).

HLD field

Encoder adjusts the hold time in the range 2.2mS to 2S.

REL field

Encoder adjusts the release time in the range 2.2mS to 3.7S.

RNG field

Encoder adjusts the attenuation RNG value in the range 0 to -60dB.
{SC SOLO} switches the side-chain signal to the solo bus.

LO CUT

Encoder adjusts the frequency of the side-chain signal Lo Cut filter.
{IN} enables the Low cut filter.

HI CUT

Encoder adjusts the frequency of the side-chain signal Hi Cut filter.
{EXT Key} enables an external key signal, which is selected via the {KEY} key associated with the MODE field below; otherwise the internal signal is used for triggering the gate.

MODE field

Encoder switches the operational mode between GATE or Deesser.
{Key} opens the key signal patch page -see chapter 10.

DE-ESS Function

A de-esser is normally used to reduce the sibilance (“s” components) in a singer’s voice.

Soundcraft Vi Series™ includes a real de-esser function that works as dynamically controlled filter. The filter can be set using the **FREQ** and **Q** encoders.

If the de-esser is active, the signal level will be reduced only in the band set by the filters, when the signal in this band exceeds the required threshold.

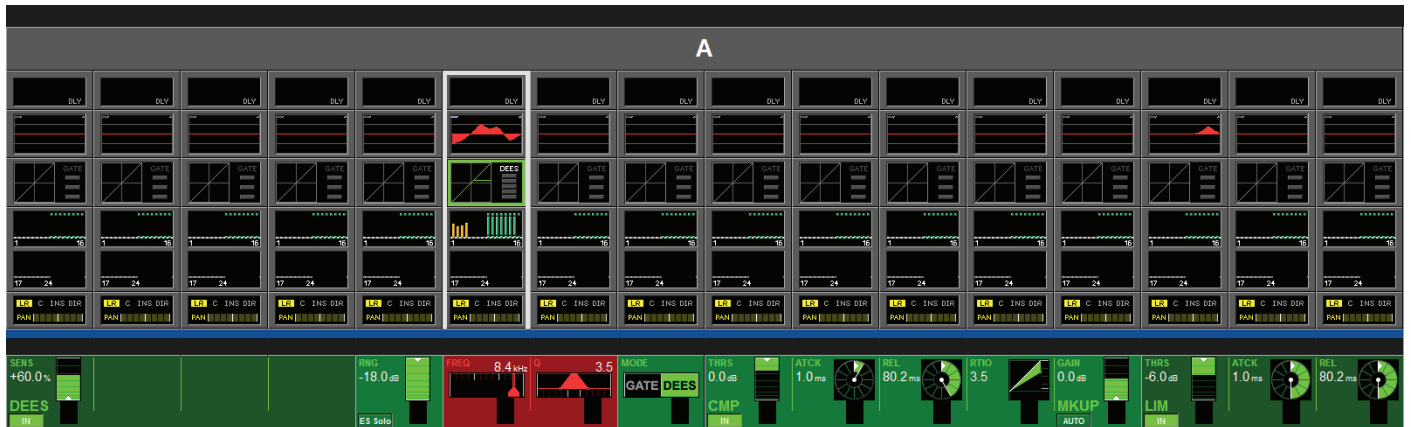

Gain Reduction Meter

The De-esser GRM, a 5-segment bar-graph is located on the right-hand side of the dynamic touch field on the screen.

SENS Field

Encoder adjusts the effect’s sensitivity value between 0 – 100%.
{IN} enables the DE-ESSER.

ES SOLO Field

{ES SOLO} switches the filtered processing signal to the solo bus.

FREQ Field

Encoder adjusts the centre frequency of the dynamic de-esser filter.

Q Field

Encoder adjusts the width of the dynamic de-esser filter.

MODE

Encoder selects the operational mode, either GATE or De-esser.



HINT: The de-esser filter can also be swept to mid and low frequencies as well as high, so the de-esser can also be used to deal with problem resonances on drums, bass and other instruments.

COMPRESSOR Function

THRS Field

Encoder adjusts the threshold value between -40 db to +18dB.
{IN} enables the COMPRESSOR.

ATCK Field

Encoder adjusts the attack time in the range 0.5mS to 98.6mS.

REL field

Encoder adjusts the release time in the range 5.5mS to 5S.

Ratio field

Encoder adjusts the ratio in the range 1:1 to 20:1.

LIMITER Function

THRS Field

Encoder adjusts the threshold value between -40 db to +18dB.
{IN} enables the LIMITER.

ATCK Field

Encoder adjusts the attack time in the range 10µS to 98.6mS.

REL Field

Encoder adjusts the release time in the range 5.5mS to 957mS.

MKUP

Makeup adjusts the overall output level from the Limiter and Compressor sections.

GAIN

Encoder manually adjusts the output level to compensate for gain reduction.
{AUTO} automatically adjusts the output level depending on the settingd of the THRS and RATIO controls.

BUS ROUTING

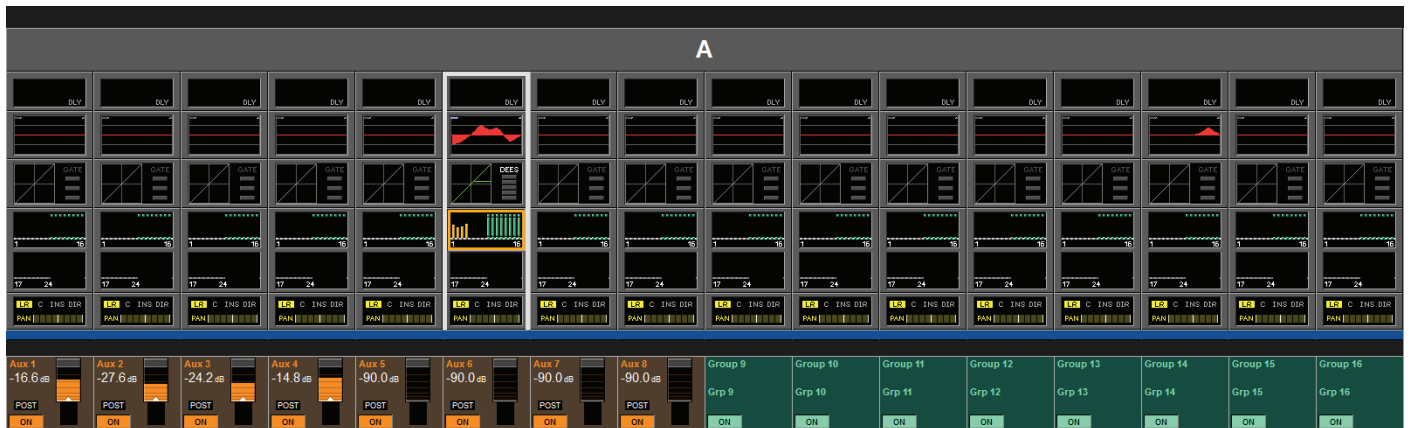

General

The first Bus page contains the controls for busses 1-16, while the second page contains the controls for busses 17-24.

What these fields look like depends on the Bus configuration.

AUX (Mono)

Encoder adjusts the send level to this BUS. Pre indicates the PRE/post state. {ON} enables the send.

AUX (Stereo)

Left Encoder adjusts the send level to both busses, while the right encoder adjusts the pan to these busses.

HINT: If the channel is paired, the right encoder adjusts the Balance to the Busses. If the 'follow channel pan' option was activated in the bus configuration, there will be no function on the right encoder.

PRE indicates the pre/post state. {ON} enables the send.

GRP (Mono)

{ON} routes the signal to this bus.

GRP (Stereo)

{ON} route the signals to both busses.

Empty

If a bus has been configured as a Matrix, it is not visible in this page.

PANNING

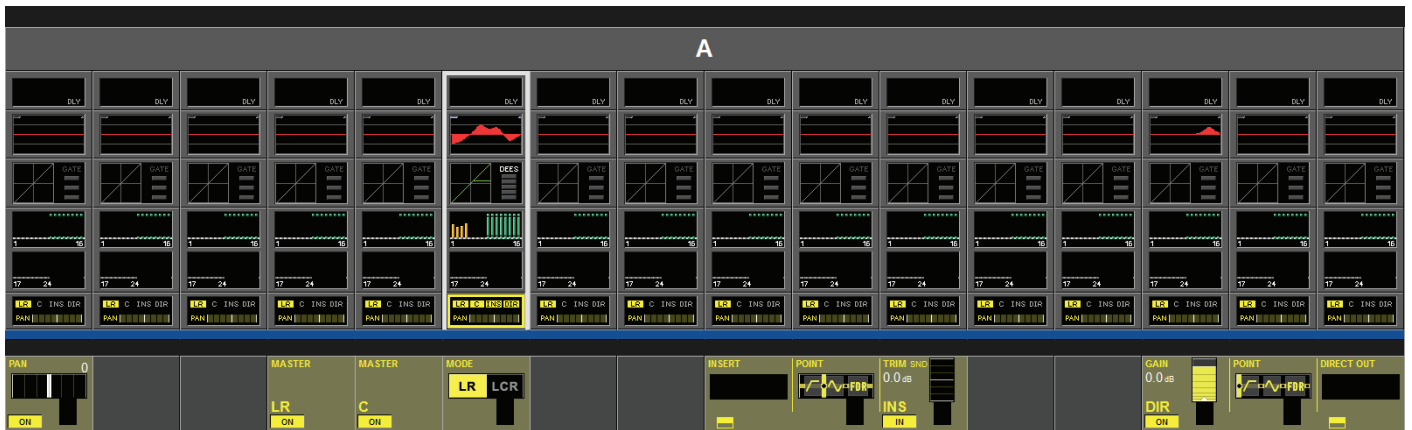

General

This page contains the output functions of the input channel. This contains the panning, the routing to the masters, the insert point and the direct out function. The Pan can work in LR or in LCR mode. In LCR mode an additional width function is available.

PAN Function LR Mode

PAN Field

Encoder sets the channel pan to the masters. If the channel is paired, the balance can be adjusted. See Audio Format / Pan / Panning, on pages 4-17 & 4-18.

MASTER LR

{ON} routes the channel signal to the Left and Right master busses.

MASTER C

{ON} routes the channel signal to the Centre master bus.

MODE

Switches the pan mode between LR or LCR. This field is not available for stereo-paired inputs.

PAN Function LCR Mode

If the Pan MODE is set to LCR an additional WIDTH field is displayed. (If the channel is paired, it is not possible to set the PAN mode to LCR.)



PAN Field

Displays the pan setting. Encoder sets the channel pan to the three masters. See Audio Format / Pan / Panning on pages 4-17 & 4-18.

WIDTH Field

In LCR mode, the encoder adjusts the level of an additional amount of signal sent to both left and right outputs.

MASTER LCR

{ON} routes the channel signal to the Left, Right and Centre masters.

AUDIO FORMAT

General

The Soundcraft Vi1™ can handle three types of audio format:

- * MONO
- * STEREO
- * LCR

Input Channels

Soundcraft Vi1™ Series contains up to 64 MONO Input channels. A STEREO Input can be built by horizontally or vertically pairing two input channels in the same bay.

Vertically and horizontally pairing can be used at the same time. See Pairing of input channels.

Mix Busses

The 32 MONO Busses can be configured to work as Mono or as odd/even paired Stereo Busses.

Masters

The three Masters L, R, C can be used as LCR Masters if the Pan mode of the input channels is set to LCR mode, otherwise L and R works as stereo output and the C can be used as an independent Mono Master.

PAN

The following table shows the destination level in relation to the PAN settings

MODE	Left position		Middle position		Right position	
	Left	Right	Left	Right	Left	Right
PAN OFF	- 3 dB	- 3 dB	- 3 dB	- 3 dB	- 3 dB	- 3 dB
PAN ON	0 dB	- ∞	- 3 dB	- 3 dB	- ∞	0 dB

HINT: If the PAN function is switched off, the gain is the same as if you had set the Encoder to the middle position.

If all TRIM, Faders and so on are in the 0dB position the outputs from the L and the R Masters are 3 dB lower than a MONO Input signal.

MONO PAN

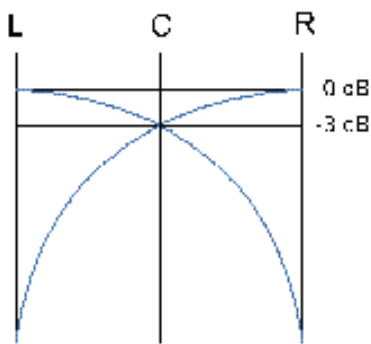

If a panning mode is set to LCR, then the WIDTH function will become active.

LCR PAN with WIDTH = 0

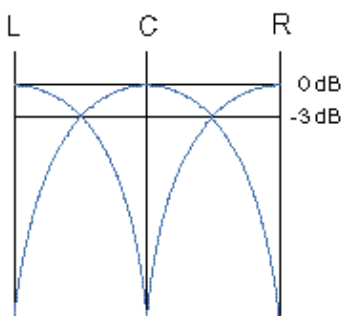

LCR PAN with WIDTH = 100

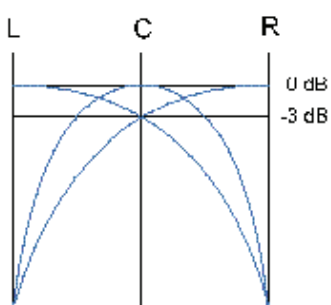

INSERT Function

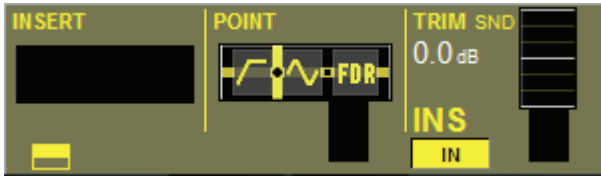

INSERT Field

Displays the label of the selected insert from the pool.
{Its VST config button} opens the Insert Pool select page.
Refer to page 10-6 for details about setting-up the Insert Pool.

POINT Field

Displays the actual point where the Insert is placed in the channel.
Encoder changes the point between:

- * Pre Processing (EQ&DYN)
- * Pre Fader.

TRIM Field

Encoder trims the insert send level in the range +- 18 dB.
{IN} activates the Insert.

Direct Out Function

GAIN field

Encoder sets the Direct Output send level.
{ON} activates the Direct Output.

POINT Field

Displays the actual point in the channel's signal path from where the Direct Output is taken.
Encoder selects the point between:

- * Pre Filter
- * Pre Processing
- * Pre Fader
- * Post Fader.

PATCH Field

Displays the patched Output.
Its {VST config button} opens the Direct Output patch configuration page (see page 10-8).

SIGNAL FLOW

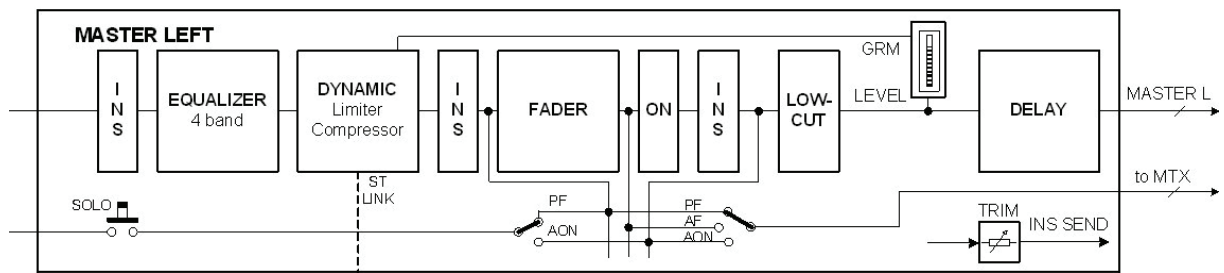

Figure 5-1: The Signal Flow In An LRC Master Or A MIX Master.



Only one of the three possible insert points can be used per master at any time.

GENERAL

The LR and C Masters are always operated with their dedicated master fader strips in the master bay. The parameters of these busses are controlled via the Master Processing Page.

The Soundcraft Vi1™ allows three different ways to access, control the level of, and change the parameters of, the other 24 output busses.

These are:

via the Master Section's Output Strips, and selecting the fader page* required,

via all of the Input Strips, using the [BUSSES 1-16] and [BUSSES 17-24] keys,

via the Vistonics™ buttons and encoders on the master section screen.



* For detailed information about Layering see chapter 8.

L,R & C Master Processing



This page is accessed by pressing the [SEL] key which is located below the L, R & C master faders. The Master processing fields are shown in the Meter Area of the Master Screen.

In order to change the parameters for EQ, Dynamics or Pan, the appropriate area on the touch-screen must be pressed.



Note: When selecting the PAN area, the page which will be displayed will be similar to the screenshot on page 5-10 except that the PAN, MASTER LR and MASTER C fields will not be present.



Note: The output levels of the L R & C Master outputs are always controlled by their dedicated faders.

MASTER EQ LINKING

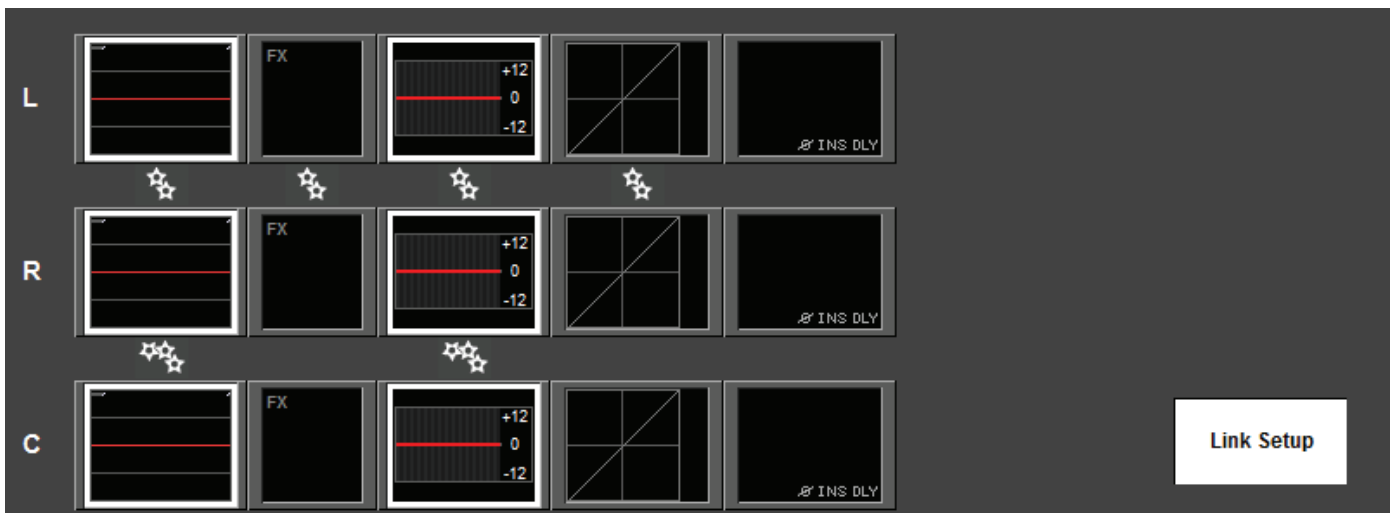

The LRC Master busses can have their Parametric and/or Graphic Equaliser sections linked for easier adjustment. Left and Right busses can be linked, or the Centre bus can be added to the linked L&R so that all three busses can be adjusted together. It is not possible to link Left and Centre or Right and Centre.

The linked state is indicated at all times by a pair of white 'gear wheel' icons between the L and R Parametric and Graphic EQ touch fields.

A similar icon with 3 'gear wheels' indicates that the C bus is also linked.

To link or unlink the EQ or GEQ sections

- . Press [SEL] below the LRC Master faders to open the Masters strip display.
- . Press the {LINK SETUP} button in the bottom right corner of the Master strip display.
- . Touch either of the L or R {EQ} touch fields to toggle the linked state on and off for the EQ. Touch the C {EQ} field to add/subtract the C bus EQ to the linked L/R pair.
- . Touch either of the L or R {GEQ} touch fields to toggle the linked state on and off for the GEQ. Touch the C {GEQ} field to add/subtract the C bus GEQ to the linked L/R pair.

The fields that are available to be toggled in and out of the linked state are shown with a highlighted white border around the touch field when {LINK SETUP} is active.

Note that the FX fields and the Dynamics fields of the L and R busses are permanently linked, and cannot be toggled in the Link Setup mode.

Default settings

The settings of the EQ and GEQ Linking for the Master busses is stored in the current Show. The links are set to ON for L,R and C busses for both EQ and GEQ, in the factory default Shows that are supplied with the console.

MASTER BAY OUTPUT STRIPS

The first way of controlling and changing the parameters of the 32 output busses described earlier is as follows.

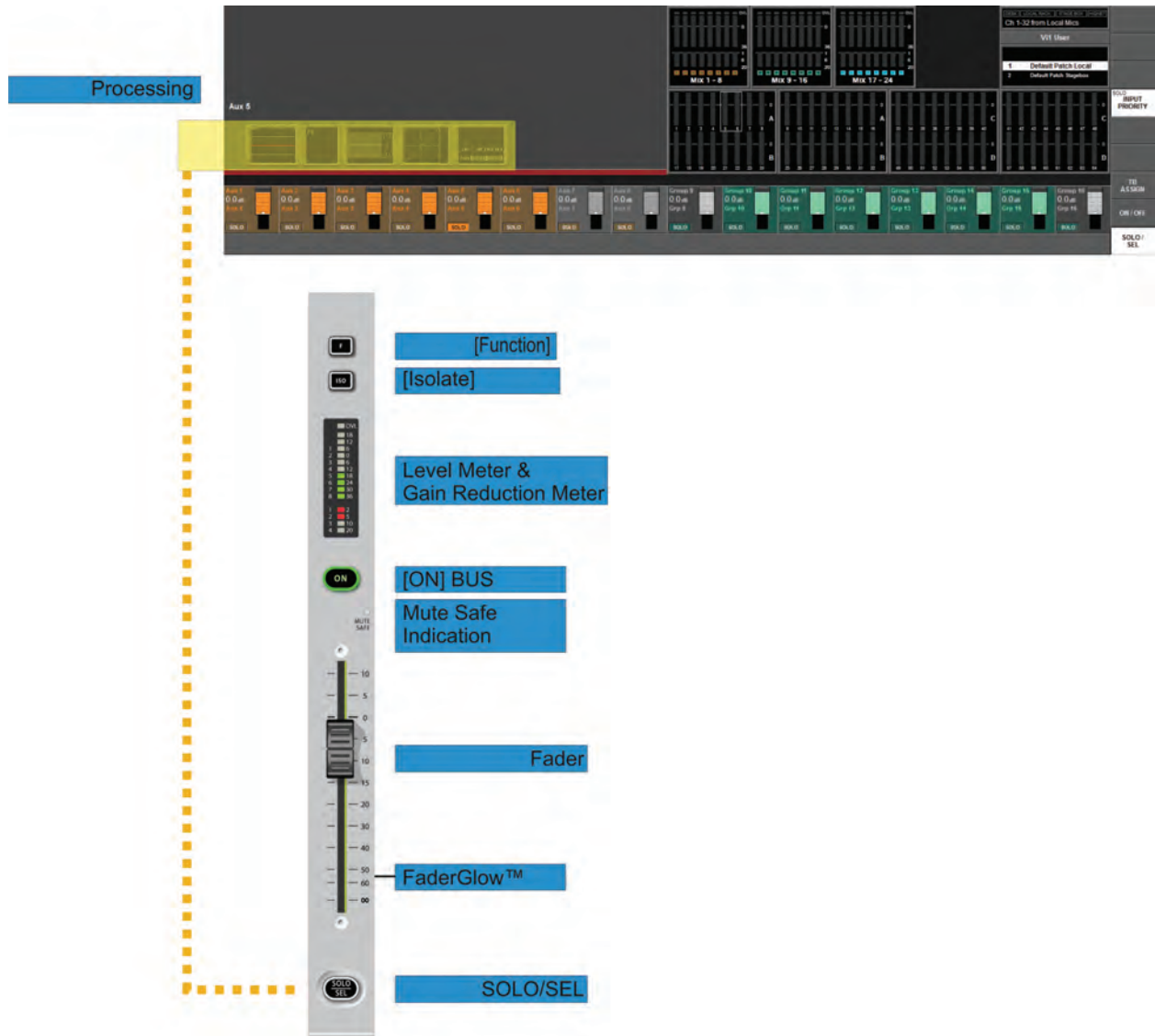

In order to select the desired output from the 24 possible choices, the correct master fader page, VCA, A, B, C or D, must first be assigned to the master bay. Once this is done, the user can select the desired fader to control the output level, and pressing its [SOLO/SEL] key opens the processing Area in the Master screen (see yellow highlight in screenshot above).



HINT: If multiple Output Solo's are activated the processing for the last-pressed Master Solo is displayed.

Bus Master Processing

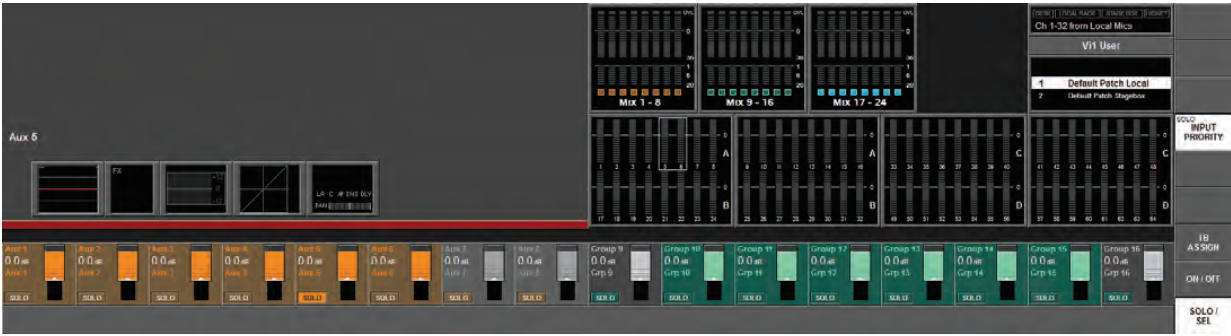

The Bus Master processing is shown in the Input Meter Area of the upper half of the screen.

In order to change the parameters for EQ, Dynamics or Pan, the appropriate area on the touch-screen must be pressed; doing so will open a page whose VST area is similar to the input channel screens.



HINT: Stereo Busses are linked. Therefore the processing strip will control both channels.

INPUT BAY STRIP USING [BUSSES 1-16] and [BUSSES 17-24]

The second method of controlling, and changing the parameters of the 24 output busses described earlier is as follows.

If the [BUSSES 1-16] or [BUSSES 17-24] key is active, the input strips on all of the input bays will be switched to control the 24 output busses.

Once this is done, the user can select the desired fader to control the required output level. In addition, the VST encoders can be used to change the bus type (Aux, Grp or Mtx) and format (Mono or Stereo).

In order to change the parameters for EQ, Dynamics or Pan, the appropriate area on the touch-screen above the required strip must be pressed; doing so will open a page similar to the input channel processing.

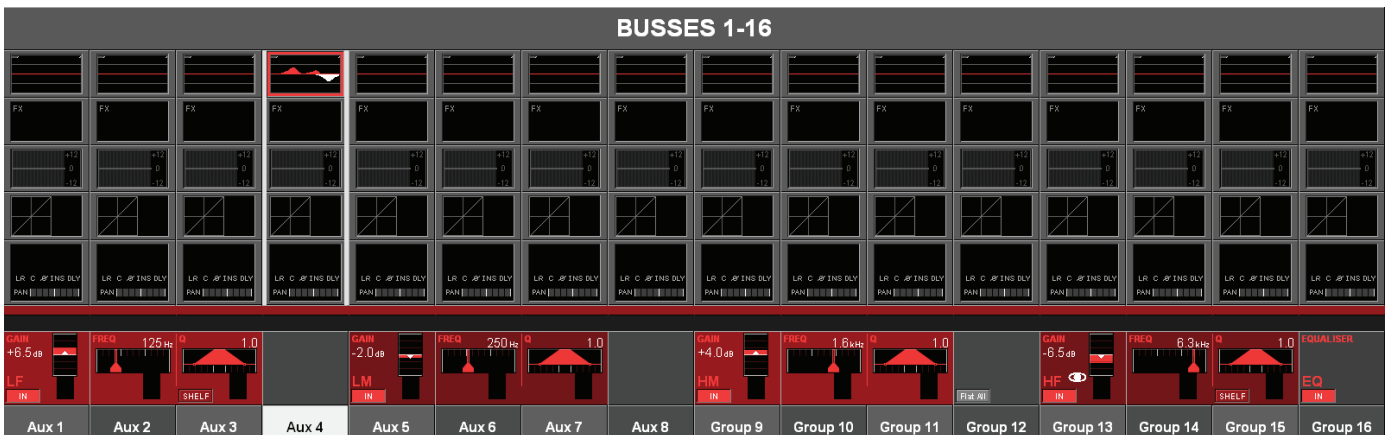

MASTER BAY VISTONICS™ ENCODERS & KEYS

The third way of controlling, and changing the parameters of the 24 output busses described earlier is as follows.

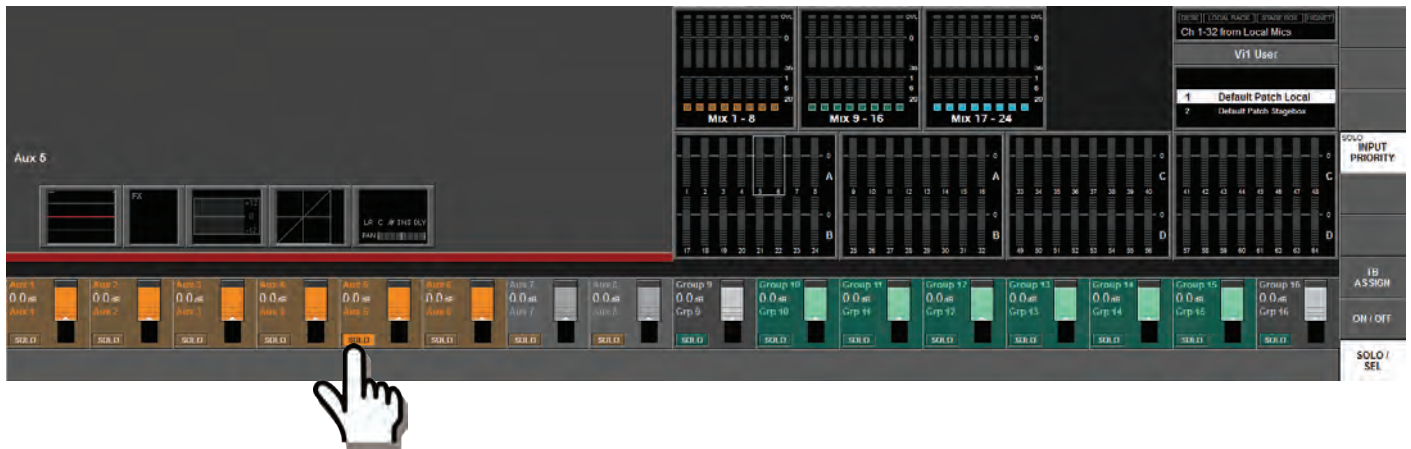

The VST encoders control the levels of the displayed output busses. To select the desired range of busses the user must press [Page A] or [Page B] just to the right of the screen. The [PAGE A] key displays busses 1-16 in the upper area, [PAGE B] displays busses 17-32.

To change output bus parameters the user must first ensure that the [SOLO SEL] key on the VISTONICS SWITCH FUNCTION panel is active (see above).

When this is done pressing the {SOLO} VST key opens the processing Area in the upper left quadrant of the screen. In order to change the parameters for EQ, Dynamics or Pan, the appropriate area on the touch-screen must be pressed.

VST Key Function

The functionality of the VST solo buttons can be set, via the three touch buttons on the far right of the screen, to TB Assign, ON/OFF or SOLO/SEL, where SOLO/SEL is the default setting. The function is the same for ALL Encoders in both pages. The [PAGE A] key displays busses 1-16 in the VST area, [PAGE B] displays busses 17-32.

CHANGING OUTPUT BUS PARAMETERS

The following pages shows bus master processing using the Input strip ({BUSSES 1-16] or [BUSSES 17-24] layer) mode as an example. Parameter changing is done in the same way if either of the other two ways of accessing bus masters is used.

Changing A Parameter Of A Bus

- * Press the desired touch field, the corresponding VST Area will open
 - * change the parameter
 - * Press the touch field again to go back to the default VST view
- OR
- * Press another touch field.

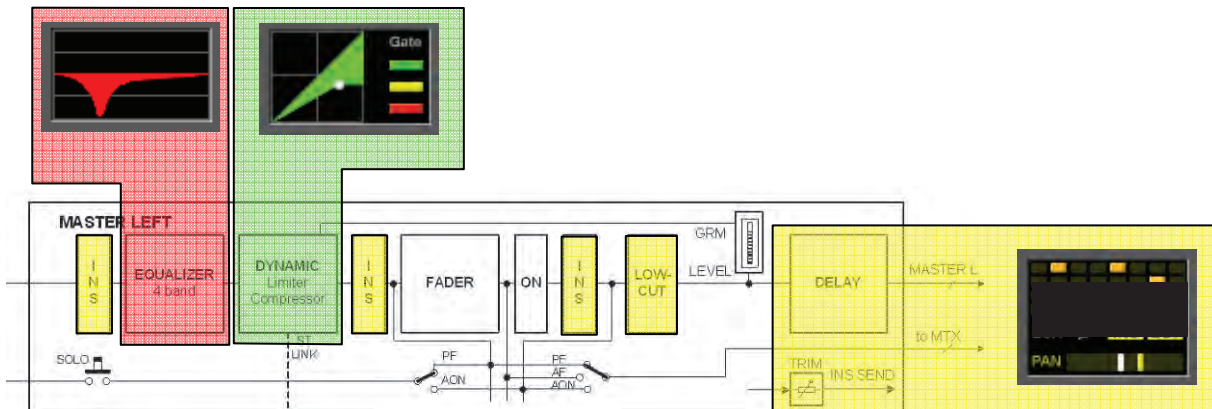

EQUALISER

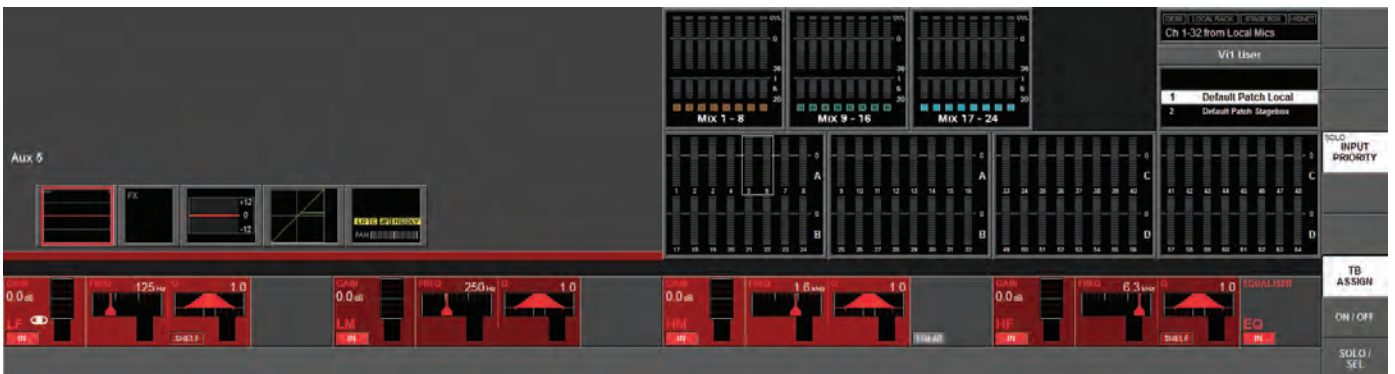

The controls are identical to those of the input channels' EQ.

The VST encoders and key areas allow the 4-band parametric EQ to be adjusted and switched in or out of circuit.

DYNAMIC



The controls are identical to those of the input channels, except there are no Gate or De-Esser modes available for output busses.

PAN



The controls for the PAN section and Insert section are similar to those of the input channels.



Note that for L, R and C master busses, the PAN, MASTER LR and MASTER C fields are not available.

The extra functions unique to output busses are as follows.

LOW CUT Field

The encoder adjusts the Low cut frequency in the range 20 to 600Hz.
{IN} switches the Low Cut filter in and out.

PHASE Field

{PHASE} inverts the phase at the output.

DLY Field

The encoder changes the output delay in the range 0 - 1000 mS.
{IN} enables the delay function.

DLY FIN Field

This allows fine adjustment of the input delay in steps of 0.02mS.

SIGNAL FLOW

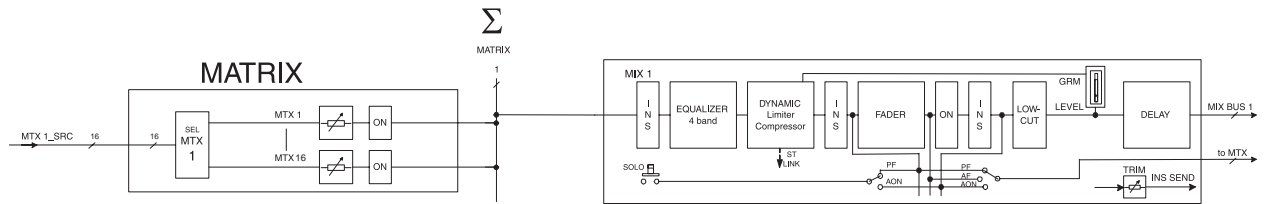

Only one of up to 8 matrix paths is visible.

FUNCTION

Instead of a simple Output matrix the Soundcraft Vi1™ has a built-in freely-configurable matrix that can have up to 8 Outputs (mono).

Each matrix output is a mix of up to 16 configurable sources and contains full processing including Equaliser, compressor/limiter and Delay.

Sources to the Matrix can be signals from busses, channel direct outputs or inputs.

Hint: The sources for each matrix out can also be individually patched, the matrix can be utilized as 8 different mixers, each with up to 16 inputs, with output processing.

Adjusting A Matrix Send Level

Ensure that the [BUSSES 1-16] or [BUSSES 17-24] keys are **NOT** selected.

Press the [SOLO/SEL] on a matrix master. All the input bays will change to the matrix contributions view and the Faderglow™ illuminates with the matrix colour (CYAN). The input strip [ON] keys act as ON for the matrix contribution signals. The fader adjusts the contribution level of the desired source (1..16).

MATRIX CONFIGURATION

This screen opens on the Widescreen Vistonics after pressing SOLO/SEL on a matrix master.



SOURCE field

Displays the patched source.

The on-screen button opens the Matrix patch configuration page.



The source for the selected matrix contribution can be chosen from Bus masters, channel direct outputs, or from actual input sources on the Local I/O, MADI card, or Stagebox. For each source it is possible to choose a variety of 'poitns' within the signal path - see next page.



MTX Point Field

The function of the Viconics encoders is shifted by touching the [MTX POINT] touch filed on the far right of the screen. The encoder changes the point from where the matrix source signal is taken.

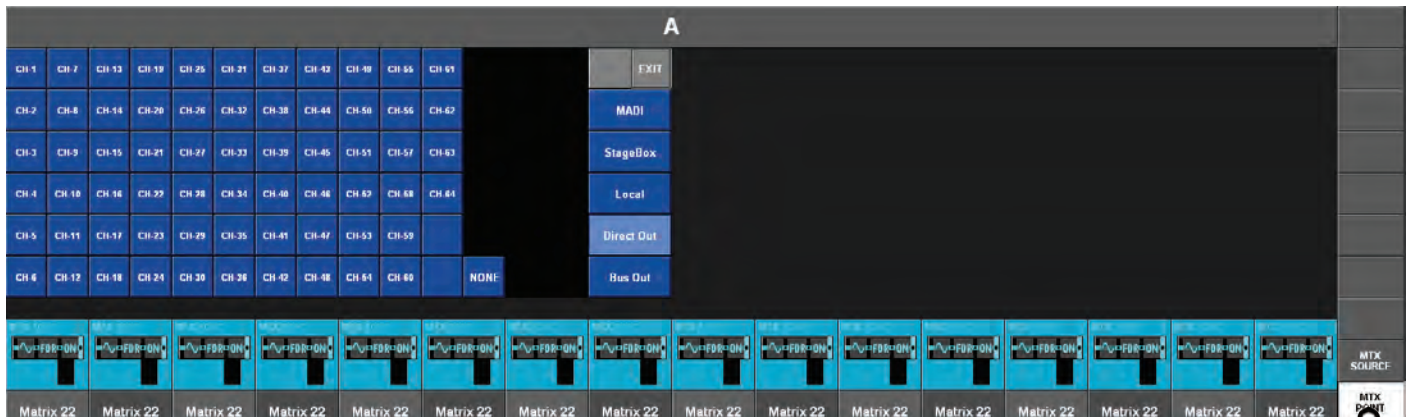

Which points are available depends on the Source selected.

	Matrix Point setting available					
MTX Source Type	Input	Pre Filter	Pre-processing	Pre Fader	Post Fader	Post ON
Input	*					
Direct OUT		*	*	*	*	
Master Bus				*	*	*

GENERAL INTRODUCTION

Each input channel strip contains one encoder located in the lower row of the Widescreen Vistonics interface. This encoder can control different parameters, depending on the settings of other parts of the console.

The master section has 16 VST encoders and 5 panel-mounted encoders with LED rings: the TB/OSC Level Control, the Solo Blend, Solo Trim & Phones Volume & Monitor Level encoders. These last five are dedicated to their respective functions.



CHANNEL VISTONICS ENCODERS

Channel encoders always control a parameter on their own channel strip. The function of the channel encoders can be globally selected via the [INPUT GAIN], [GATE THRS] and [PAN] keys on the Encoder Mode panel.



[USER1] and [USER2] are currently used to set the channel encoders to control the AUX 1 and the AUX 2 levels respectively.

HINT: If [ALL BUSSES] is active or a MATRIX output is soloed, the channel encoders are disabled and have no function (the previous function is remembered however).

CHANNEL VST ENCODER



VST Encoder Priority

If a higher priority assignment action occurs, VST encoder functions change immediately to this mapping. The priority order of the possible assignment actions is:

Priority Function

highest	CHANNEL EXPANDED FUNCTION (e.g.: EQ, Dynamics, etc)
	FOLLOW OUTPUT SOLO
	FAST ASSIGN
lowest	Channel Encoder Function (see previous page)



HINT: If any touch field is activated, the 16 VST encoders are assigned with expanded channel function parameters (see Chapter 4 for full details).

Changing Encoder Function

The function assigned to the VST encoders can be changed by the user via the Visonics Mode panel.

The two [FAST ASSN] keys provide a very fast way to temporarily assign a bus function to a VST encoder row. Press and hold one of the [FAST ASSN] keys, then press one of the Output Masters' [SOLO/SEL] keys (there will be no influence on audio, the Output solo is not activated). The relevant row of VST encoders will now be assigned to that Output master, and the [FAST ASSN] key in question will illuminate.



Hint: Only Output Masters which are configured as Auxes use the encoders. Group Masters do, however, use the VST button next to the encoder.



HINT: Fast assign mapping is removed by pressing/releasing [FAST ASSN]. Fast assign always works GLOBALLY for all input strips



The [FLW] key activates the FOLLOW SOLO function for the encoder row. This means that pressing an Output Solo/ sel will automatically assign the soloed Output to the row, overriding the default or the [USER] selection. Note that this FLW button cancels the FLW mode for input faders, and vice-versa.

The {PAN} mode touch button only has an effect on Aux busses which have been configured as stereo pairs. If such a pair is assigned to the VST encoder row, and if the {PAN} key is active, the encoders will control the pan between the pair rather than the contribution level.

The {GLOBAL PRE/POST} touch button isn't used for any encoder functions, but for the sake of completeness its function is described here. The [PRE/POST] key allows the user to configure Aux sends from channels, when they are assigned to the VST encoder row, as pre or post-fader.

MASTER BAY PANEL ENCODERS

The master section has four panel-mounted encoders with LED rings: the TB/OSC Level Control encoder, and the Solo Blend, Solo Trim & Phones Volume encoders. These are all dedicated to their respective functions. A description of their functions is given in chapter 9 of this manual.

MASTER SECTION VST ENCODERS

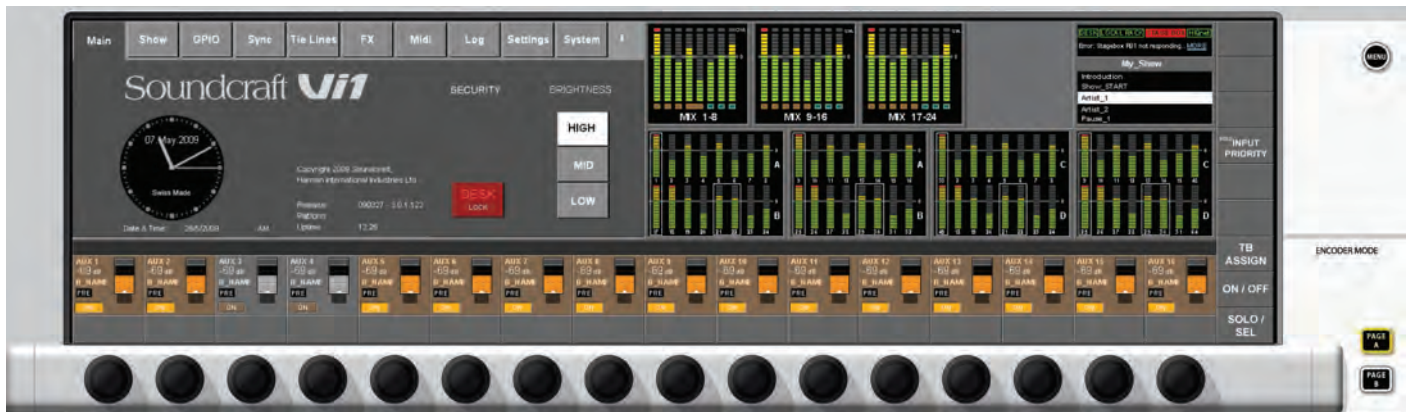

The default setting for the Master VST encoders is as the output level controls for Master Outputs 1-16. This can also be selected by pressing the [PAGE A] key on the Master Vistonics Mode Panel (see Figure 7-6). Pressing [PAGE B] will cause the Master VST encoders to be assigned as the output level controls for Master Outputs 17-24.

The Master VST encoders can also be assigned to Master Output Expanded Functions (e.g. EQ, Dynamics, etc.). When a Master Output {SOLO/SEL} key is touched, it opens the Processing Area in the Master VST screen. If then a particular touch-area is touched, the VST encoders are assigned to appropriate expanded functions. These functions are all described in detail in chapter 5 of this manual.

LAYERING (FADER PAGES)

GENERAL

Layers, or Fader Pages, allow the user to access different views of the DSP channel structure of the mixer, on the control surface.

INPUTS

The Control Surface for the Soundcraft Vi1™ contains one 16-fader Input Bay that allows direct access and state information overview for 16 Input Channels.

Therefore four layers are required to allow operation for all 64 inputs, or 2 layers for 32 input channels. Changing Layer is done by simply pressing the desired Input Fader Page key [A] or [B] or [C] or [D].

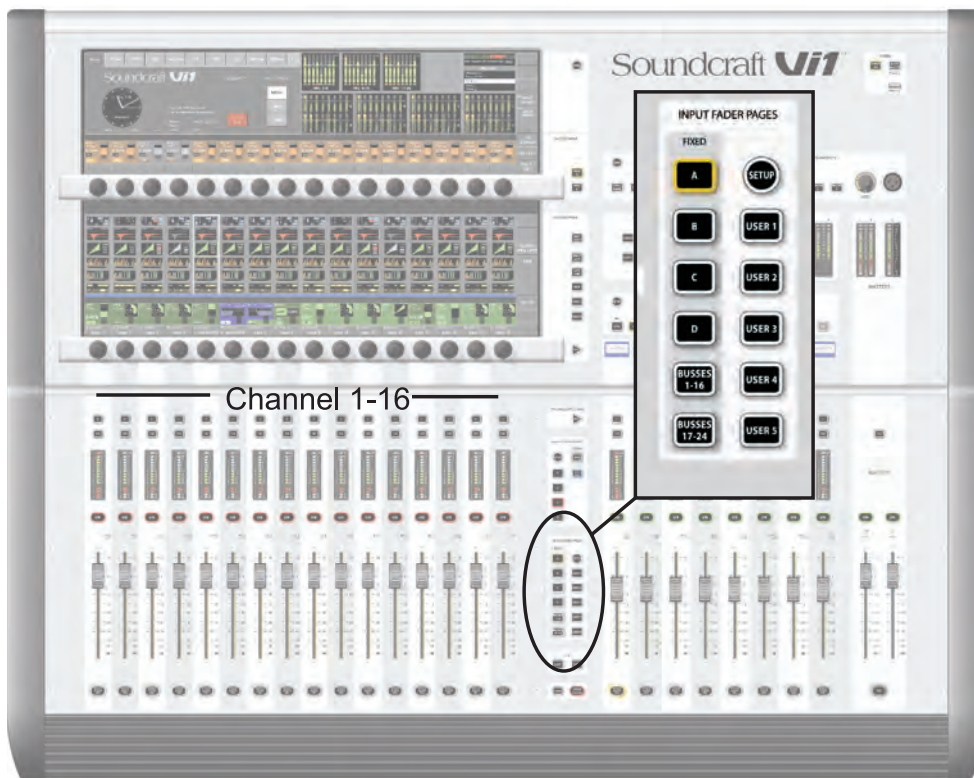

Additionally, there are 5 user-configurable layers, where the faders can be selected to control any combination, such as:

- * Arrange channels in any order on the surface.
- * Assign VCA master faders along-side channel faders.
- * Assign an important channel to the same fader on all 5 User Pages, so that it never disappears from the surface.
- * Assign only one half of a paired channel to User pages, saving faders.
- * Assign Stereo Aux and Group Masters to a single fader in the Output section, instead of having to use a pair of faders for stereo busses.
- * Assign VCA Master faders along-side bus master faders in the Output section

There are five User Defined pages User 1, 2, 3, 4 and 5 that can be created, and each of these can contain any combination of the channels that appear on the three Fixed layers. It is also possible to arrange VCA Master faders within the User-defined Fader pages, along side input channels. There are no restrictions on how many times you can use a particular channel, so for example it is possible to assign a vocal channel to the same fader in all five User Pages, meaning that it will appear to remain in the same place on the surface regardless of which User Page is selected.

To configure a User layer

Press the Setup button in the Input Fader Page control section.
This opens up a setup screen across the Vistonics screens.



Each Setup screen contains five rows of buttons, corresponding to the User Pages 1, 2, 3, 4 and 5 for the 16 fader strips. If you load a Default Show, all of the faders in all of the layers will have a default setting of NONE, which means that no channels are yet assigned to any of the faders in the User Pages.

To start assigning channels to the fader Strips, touch any of the buttons labeled 'NONE' in the previous screenshot, corresponding to the position and layer of the fader you want to assign something to. Normally you would start at the top left and work across each layer, assigning the faders in order.

Touching any of the 'NONE' buttons opens up the 'Channel Select' screen that then allows you to choose any of the input channels on the desk to be assigned to your chosen fader.

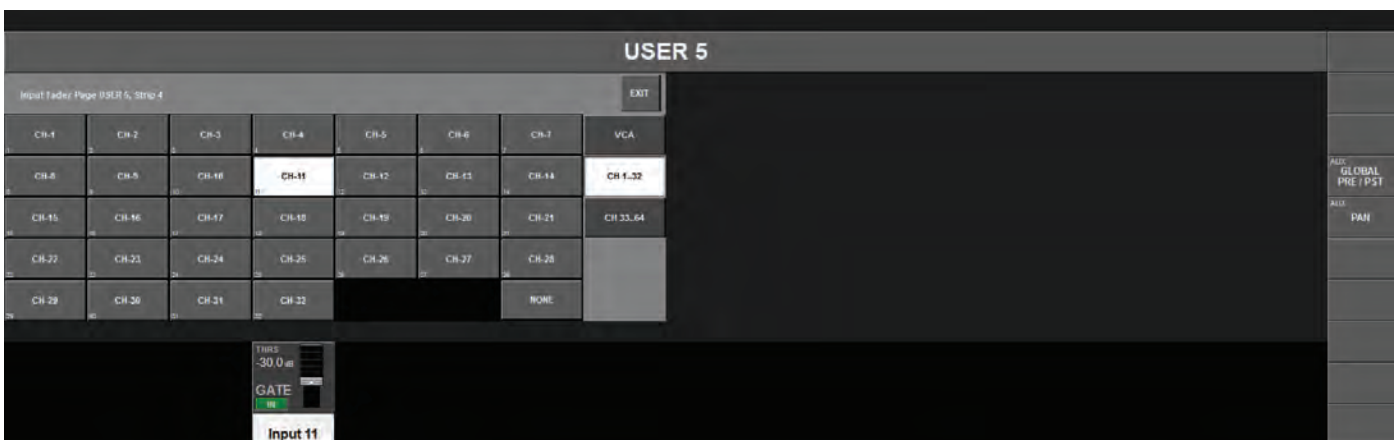

The tabs on the right side of the screen allow all available input channels or the VCA Masters to be accessed.

Each channel select button shows the channel's 'short label' name in the centre of the button, and the channel's number, corresponding to its position on the fixed layers A/B/C/D, in the bottom left corner.

In the case shown above, channel 11 is being chosen to be the assignment for Strip 4 on User Layer 5. As soon as you select your channel, the select screen will automatically close and return to the Setup page, and you will be able to see your assigned channel on the first strip of User layer 1, like this:

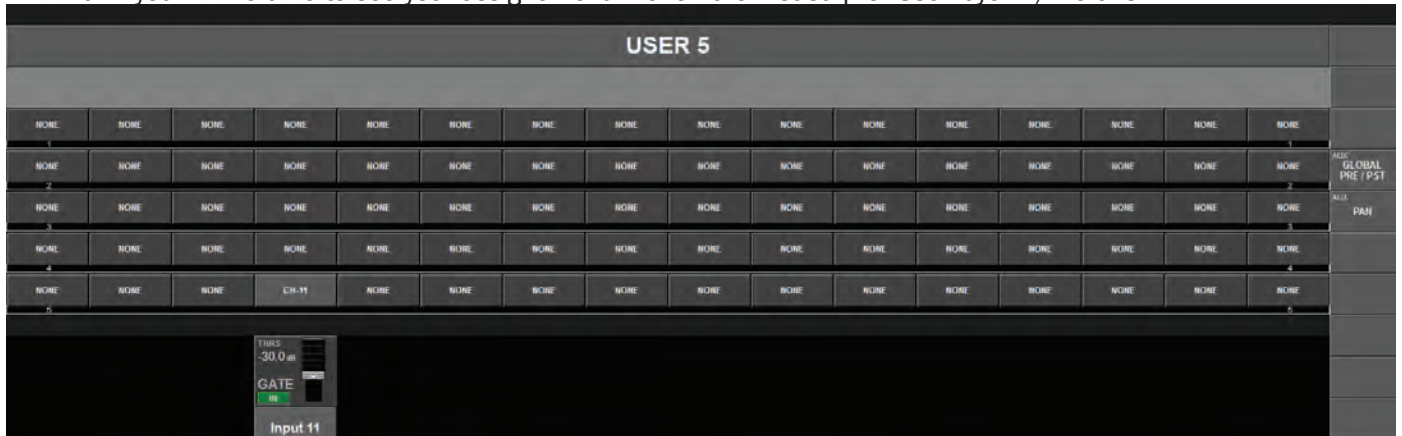

Assigning VCA Master Faders to Input strips

As well as choosing input channels to assign to fader strips on the User Layers, it is also possible to assign VCA masters alongside the inputs. The 8 VCA Master faders are displayed in the channel select page by

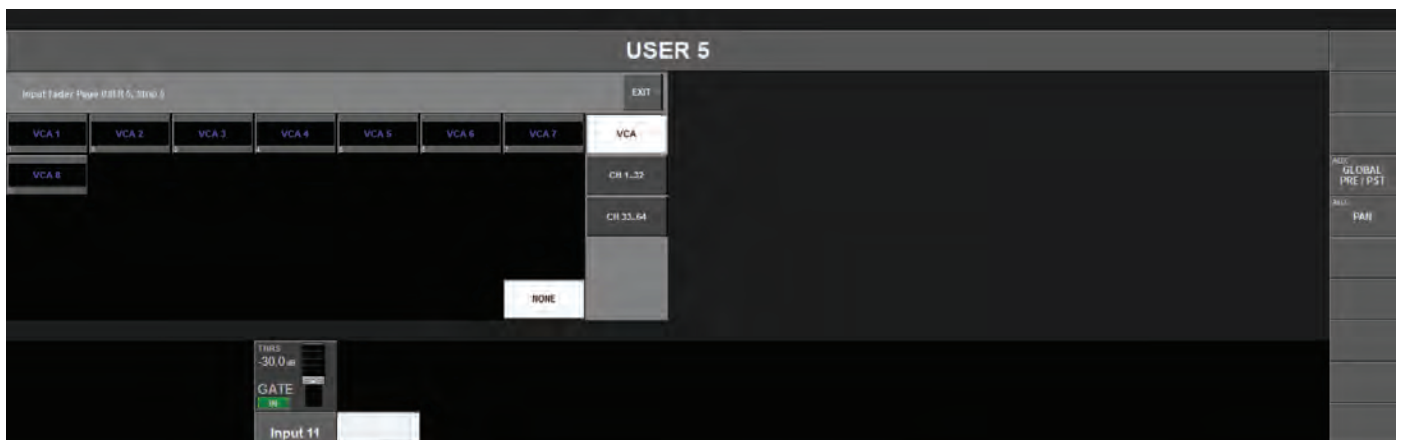

touching the VCA tab on the top right of the screen:

Hint: It is also possible to leave the channel select screen open, without selecting an channel or VCA, and use the Solo/Sel buttons on the fader panels below the desk to scroll to a different fader strip to the one you started with, before selecting the required channel.

OUTPUTS

Bus Masters can be accessed in any of three ways, depending what is convenient for the way the desk is being used: with the master fader strips in the Control Bay area; with the encoders in the VST Master area; or with the BUSSES 1-16 and BUSSES 17-24 layers on the Input Bays.

Master Fader section

There are 6 layers for the master bay: VCA and A to E. They map the following master faders to the master bay as follows: VCA maps VCA 1-8, A maps busses 1-8, B maps busses 9-16, and C maps busses 17-24.

Layers D and E are normally unassigned, and can be setup like the input layers, to show whatever the engineer chooses from the output busses available. In fact, layers A, B and C can also be user-customised to show priority busses.

In the factory-default Front-Of-House Show, busses 1-8 are set as Aux, busses 9-16 are set as Groups, and busses 17-24 are set to Matrix. If the layer configuration is changed, the new setup can be saved in your own show file.

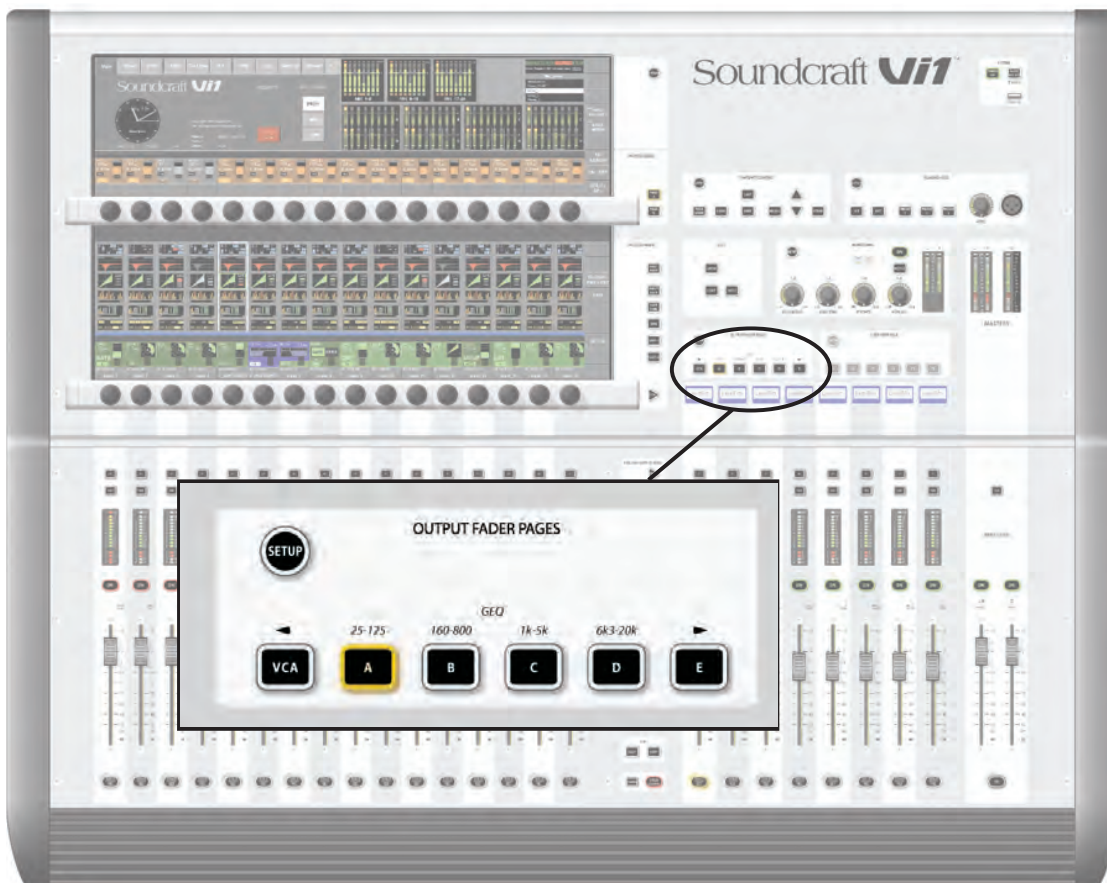

To change the configuration of an output layer, press the SETUP button. The upper left part of the screen will show which output busses are assigned to each output fader. (see screenshot on next page).

Changing the assignment is done exactly as described for input fader pages (see page 8-2).

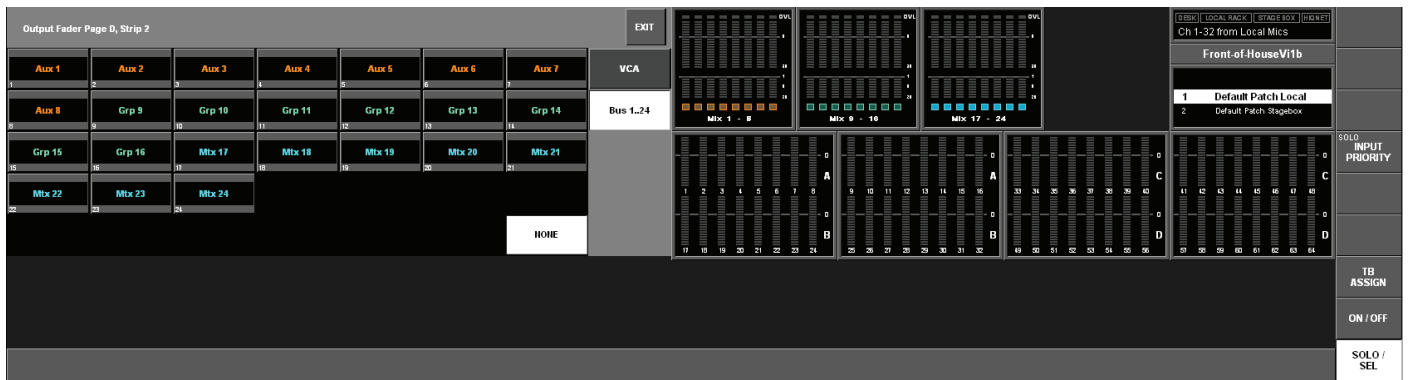

ALL Busses

If [BUSSES 1-16] or [BUSSES 17-24] is selected in the Input Fader Page selection, all 24 Busses can be assigned to the Input Fader section on two layers. These layers allow a quick way to compare the outputs or quickly change the processing of the Busses.

HINT: Configuration of the BUSSES, e.g. Format (mono/stereo) and Type (Aux, Grp, Matrix) is also handled in these Layers. In fact, this is the only method of accessing the format and type.

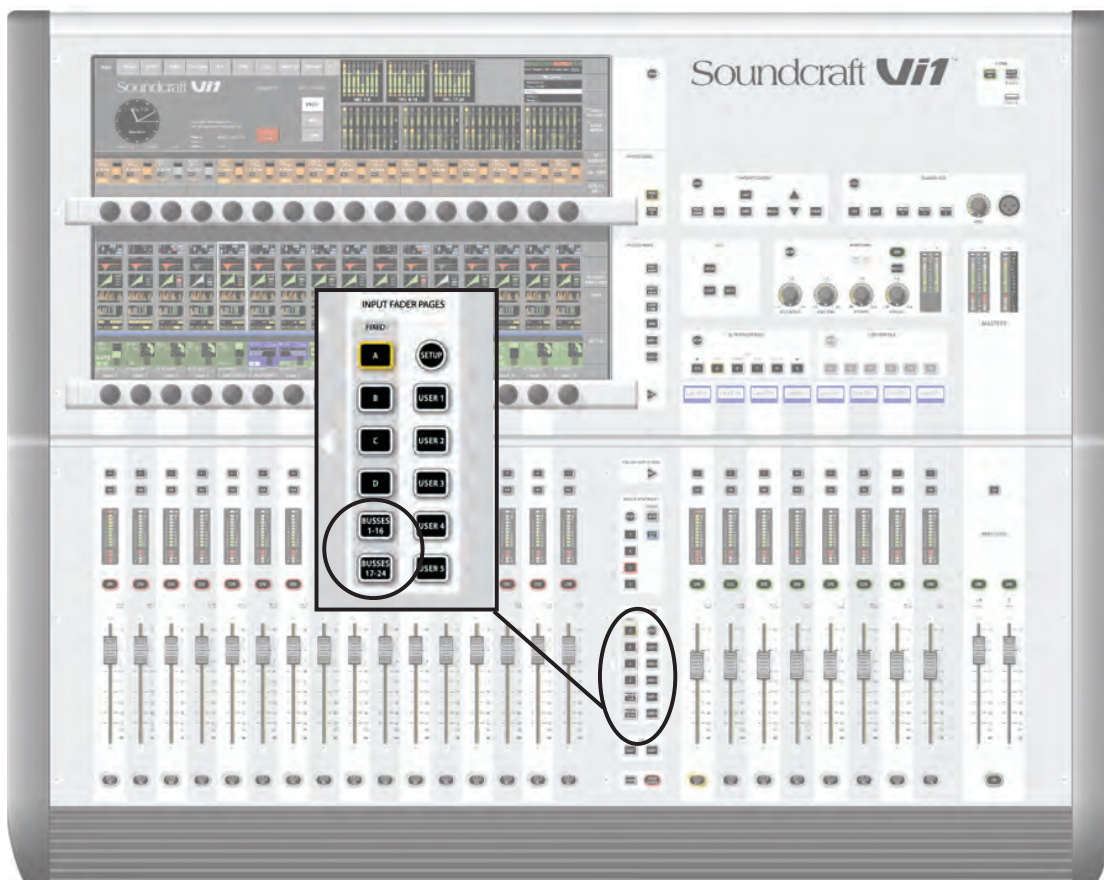

VST Master Area

The Widescreen Vistronics Output section allows all 24 Bus Masters to be accessed even if the 8 output faders are assigned to control VCA Masters, and the Input faders are assigned to input channels.

There are two layers of encoders: Page A displays busses 1-16, Page B displays busses 17-24.

In the factory-default Front-Of-House Show, busses 1-8 are set as Aux, busses 9-16 as Groups, and busses 17-24 are set to Matrix.

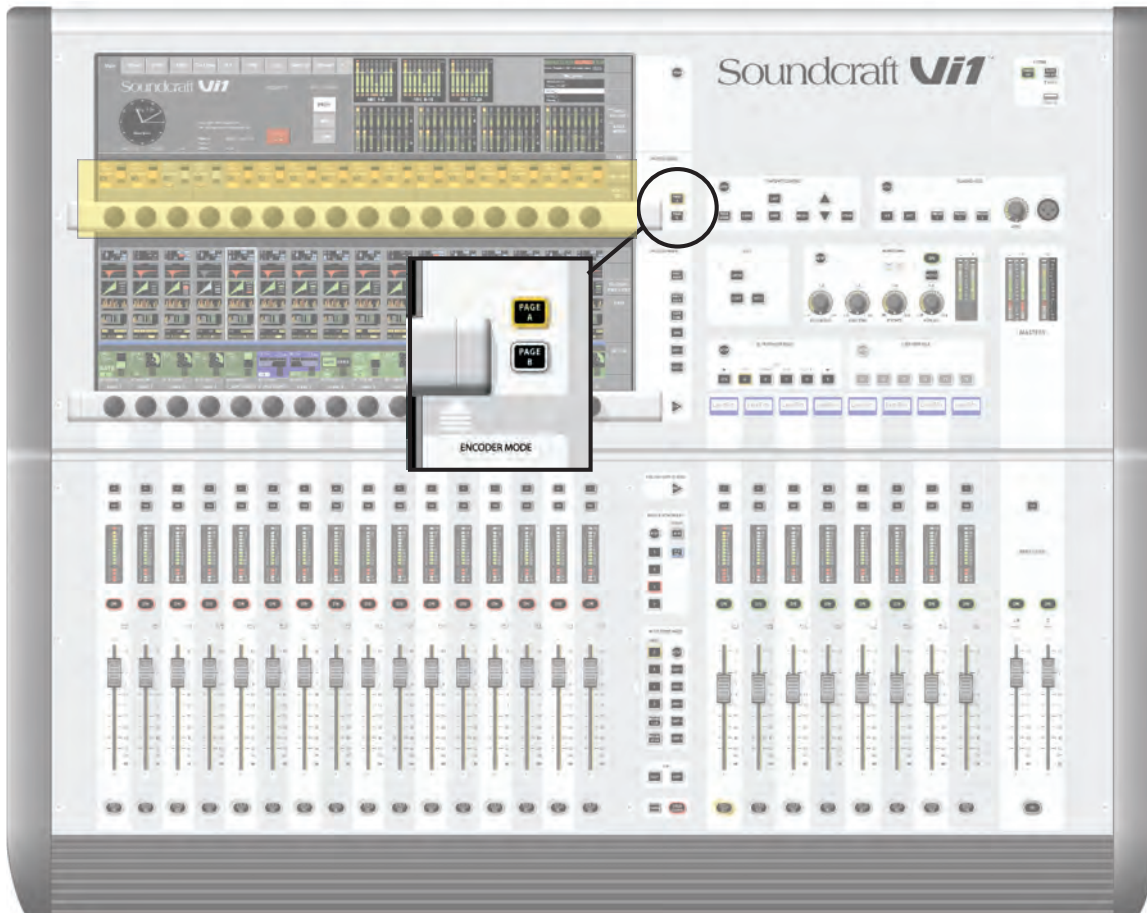

VCA & MUTE GROUPS

The Soundcraft Vi1™ supports up to 4 MUTE Groups (MG) and 8 VCA masters.



VCA/MUTE GROUP INDICATION

Each input and output strip meter contains a set of 8 VCA and 4 mute group display legends, which show the VCA and Mute Group assignment on the meter leds when DISPLAY [VCA/MG] is pressed instead of [METER], for all strips.

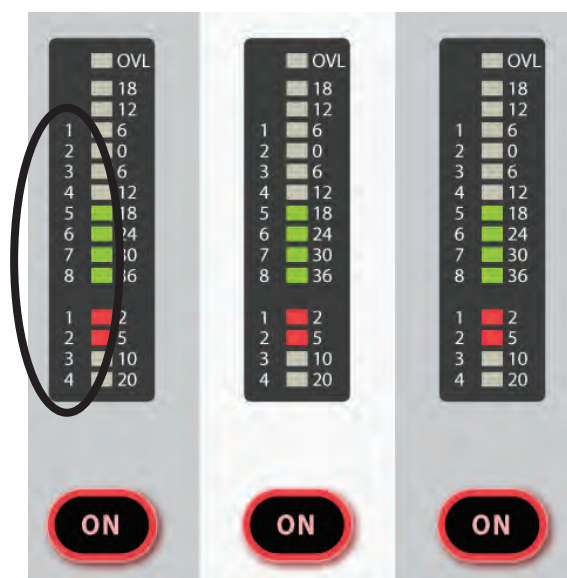

MUTE GROUP MASTER SWITCHES

The four switches labelled 1-4 activate Mute Groups when pressed.

VCA CONTROL GROUP BEHAVIOUR

Up to 8 VCA Groups can be created. In the normal configuration of the console with a single Output section block, there are 8 faders available for VCA Masters. Similarly there are 8 assignment LEDs on the Channel and Output meters.

AUDIO BEHAVIOUR

When a VCA Group has been created, by assigning Input or Output channels to a VCA Master, the following behaviour is followed:

- * The Master fader setting applies its dB value as an offset to all member channels. **The member channels' fader positions remain unchanged.**

- * If a channel is assigned to more than one VCA Group, the resultant offset applied to the channel is calculated as the arithmetic sum of the dB values of each VCA Master fader. Any Master fader reaching $-\infty$ dB will set all member channels to $-\infty$ dB, regardless of other Master fader settings. The maximum gain applied to a member channel as the result of the channel fader setting plus offsets from VCA Master faders is limited to +10dB.

- * The [ON]/Off switch on the VCA Master fader acts as a remote control for all member channels' On/Off switches. If a channel which was previously ON is turned OFF by the action of a VCA Master On/Off switch, the channel's ON switch will illuminate in RED to distinguish this condition from a manually OFF channel.

The VCA Master On/Off switch itself has only 2 states, and always illuminates RED when OFF, Green when ON. (There is no non-illuminated condition). This is because VCA Master On/Offs cannot themselves be remotely muted, so the Red helps to identify 'Muted' VCA masters.

- * The [SOLO/SEL] switch on the VCA Master fader acts as a remote control for all member channels' Solo switches. The channel 'Sel' function is not activated however.

ASSIGNING VCAs

1. Press the VCA/MUTE GROUP's [SETUP] key. It will glow blue.
2. Choose the required VCA master by pressing its [SOLO/SEL] key, which will also glow blue. Note that if the output fader page is not displaying VCAs it will be necessary to select the [VCA] page first.
3. Press the [SOLO/SEL] key of any channel(s) that is (are) to be assigned to the selected VCA master.
4. Press [SETUP] again to finish the process, or press another VCA master's [SOLO/SEL] key to assign more channels to another VCA master. The assigned VCA Groups will show up on the indicated blue leds on the meter if DISPLAY VCA/MG is pressed.

Hint: If the SETUP mode is not switched off after assigning VCAs, channels cannot be soloed.

Hint: The assignment of VCAs should be done with the channel or group faders and the VCA master, to which assignment is being made, being at or near a nominal operating level: i.e. don't assign a VCA master to a channel or group if the VCA master is at -40dB while the channel or group is at 0dB.

ASSIGNING MUTE GROUPS

1. Press the VCA/MUTE GROUP's [SETUP] key. It will glow blue.
2. Press the required mute group [1-4] master key, it will glow red. The MUTE/VCA display strip on each channel will show mute assignments in red.
3. Press the [SOLO/SEL] key of any channel(s) that is (are) to be assigned to the selected MUTE master.
4. Press [SETUP] again to finish the process, or press another MUTE master's key to assign more channels to another MUTE master. The assigned mute groups will be indicated in the red meter leds if DISPLAY VCA/MG is selected.

Hint: If the SETUP mode is not switched off after assigning MUTES, channels cannot be soloed.

ASSIGNING VCAs AND MUTE GROUPS TO OUTPUT CHANNELS

It is possible to assign VCAs and/or MUTE Groups to any of the 24 output channels (but not the LRC master outputs). In step 3 of either of the assignment processes above, select one of the output fader pages [A] to [C], and then use the [SOLO/SEL] key below the output fader to assign it to the VCA or Mute Group in question. Note: you must not assign a VCA group to both input and output channels.

VCA GROUPS WHEN AUX SENDS ARE CONTROLLED BY CHANNEL FADERS

The VCA Groups on the Soundcraft Vi1™ are normally used to control groups of the input channel faders, for use by FOH engineers. In this case they are used to group mono and/or stereo channels together under control of a single master fader, for easier control during a mix. The member channels can also be Soloed or Muted, using the VCA Master [SOLO/SEL] and [ON] switches.

For the Monitor mix engineer, controlling channel faders is of secondary importance to controlling Aux sends from channels, and so on Soundcraft Vi1 the functionality of VCA Groups has been extended to control of groups of Aux sends as well as channel faders.

Effectively, because there can be up to 24 mono Aux sends configured on the console, this means that there are up to 24 sets of VCA groups (each with up to 8 Group Masters), in addition to the set of main channel fader VCA groups. This means that there are up to 32 virtual sets of 8 VCA master faders in total.

VCA control of Auxes is only available by activating the Follow Output Solo [FLW] key next to the master faders, note that the pair of [FLW] keys for the VST Encoder Rows will not access this function. Due to the Follow Output Solo functionality, it is possible to control only one Aux mix via VCAs at any one time.

Procedure

Select the Aux required by selecting the required master fader bank [A]-[C].
 Activate the [FLW] key next to the master faders.

Press the [SOLO/SEL] key, under the master fader, for the required Aux. Alternatively, the Aux can be soloed using the solo switches in the Master Viconics™ screen.

Press [VCA]. The FaderGlow™ for the master faders will change to blue. The faders will move to show the offsets which are being applied to the Aux feeds from those channels which are assigned to the VCAs now being displayed in the master section. Note that at this point the VCA Master [SOLO/SEL] keys have no function. The VCA [ON] switch controls the Aux send On/Off on the member channels (the channel's [ON] switch is illuminated red if the Aux send is turned Off by a VCA Master [ON] switch.)

To select another Aux for adjustment, press the required bank key [A]-[C], solo the required aux (or solo directly on the VST screen), and press [VCA] or [E]. To exit, press [SOLO CLEAR] and de-select [FLW].

In the example in Figure 9-3, input channel 1 has been assigned to VCA 1, and channels 2,3 & 4 have been assigned to VCA 4. In order to use the VCAs to control the Aux 5 sends from the input channels proceed as follows: select bank A, activate [FLW], solo Aux MASTER 5 using its [SOLO/SEL] key, press [VCA]. VCA 4's fader will now control the Aux 5 feeds from input channels 2, 3 & 4; and VCA 1's fader will now control the Aux 5 feed from input channel 1.

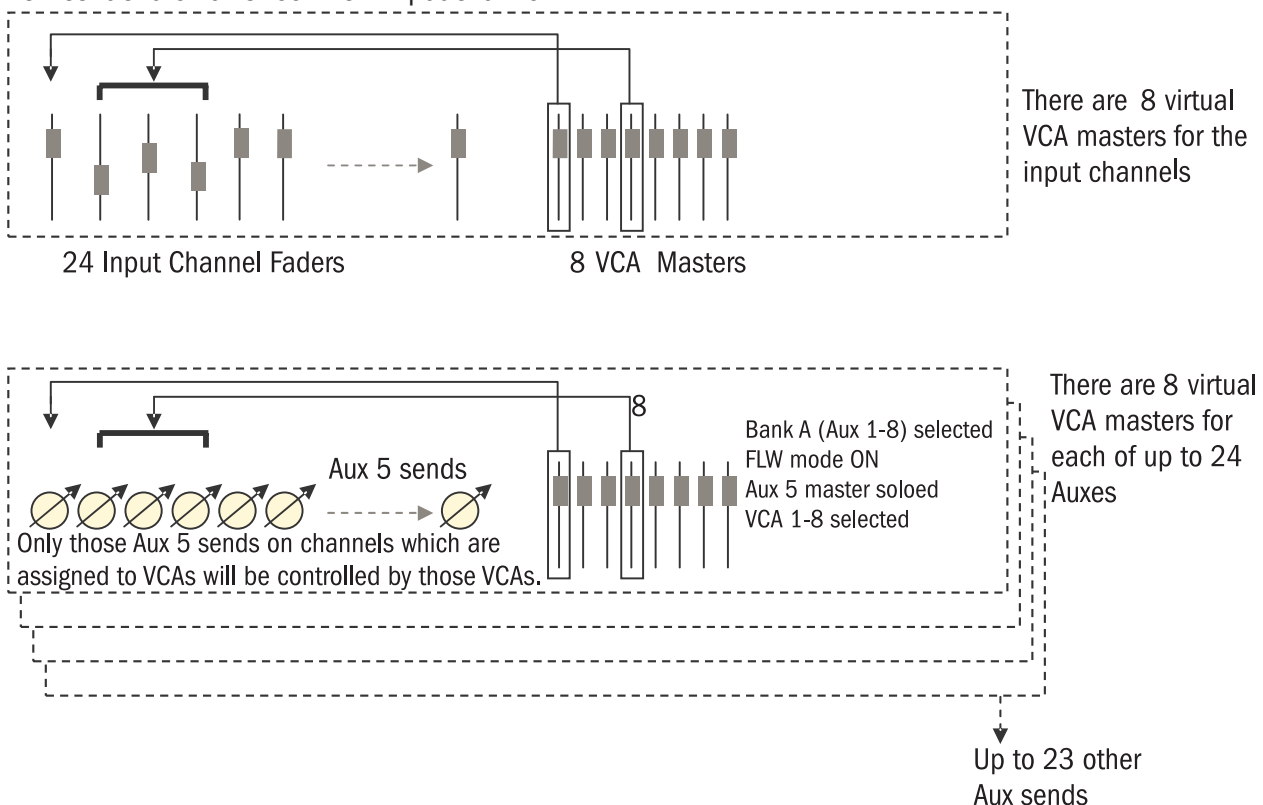

SIGNAL FLOW

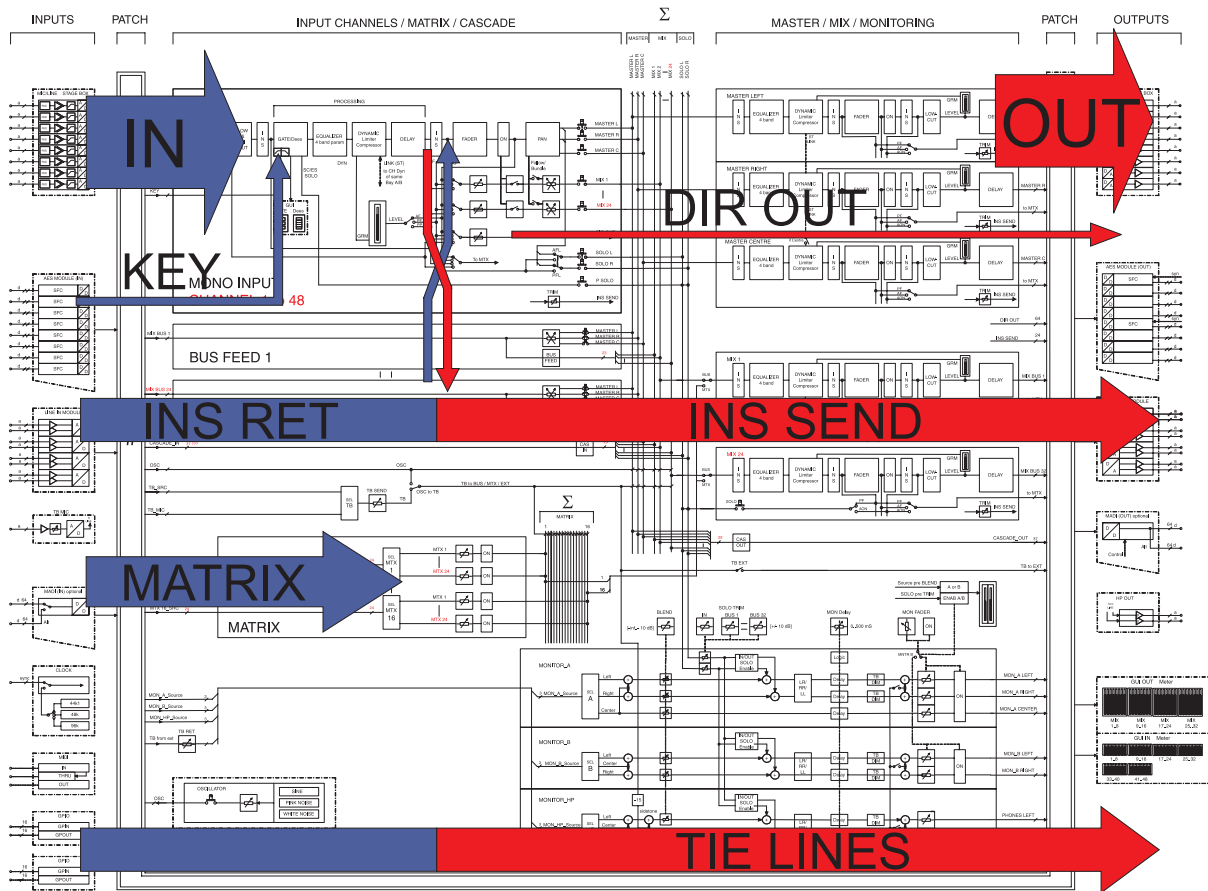

Introduction

An electronic 'patchbay' exists at various points within the console's signal path. In the diagram above, 'blue' indicates patching for inputs arriving at the console, and red arrows indicate patching for signals leaving the console. The control panels for patching within the console are coloured in accordance with this convention.

OVERVIEW

The patch system of the Soundcraft Vi1™ is divided into functional groups allowing it to be accessed easily and intuitively via the console work surface.

The following table gives an overview of where the Patch functions are located on the console work surface.

Patch Function	Location			
	Input Bay	Input Bay <i>[BUSES1-16] or active [BUSES17-24]</i>	Input Bay <i>MTX [SEL] on master section active</i>	Master Bay <i>[SEL] active</i>
Input	Input section			
Output		Pan section		Pan section
Insert (channel)	Pan section			
Insert (master)		Pan section		Pan section
Direct Out	Pan section			
Key Signal	Dynamics section			Dynamics section
Matrix			Direct access	
Tie Lines	[MENU] then the <TIE LINES> tab			

GENERAL RULES

The following rules are valid for all patch pages.

- * Channel Label (name) entries are located near the Patch configuration.
- * Source Patches are colour-coded BLUE, while destination patches are RED.
- * Patch Pages open in the upper screen area by pressing the Patch Configuration button.
- * Patch Pages close by pressing the Patch Configuration button again or by pressing the EXIT button.
- * Sources and destinations are grouped location-wise (local I/O, Stage Box, Madi).
- * If the Page is open, pressing SEL of another Channel moves the Page to this channel.

INPUT

The Input Patch connects an input connector or MADI channel with the desired input channels. Each input connector signal can be patched to more than one input channel at the same time.

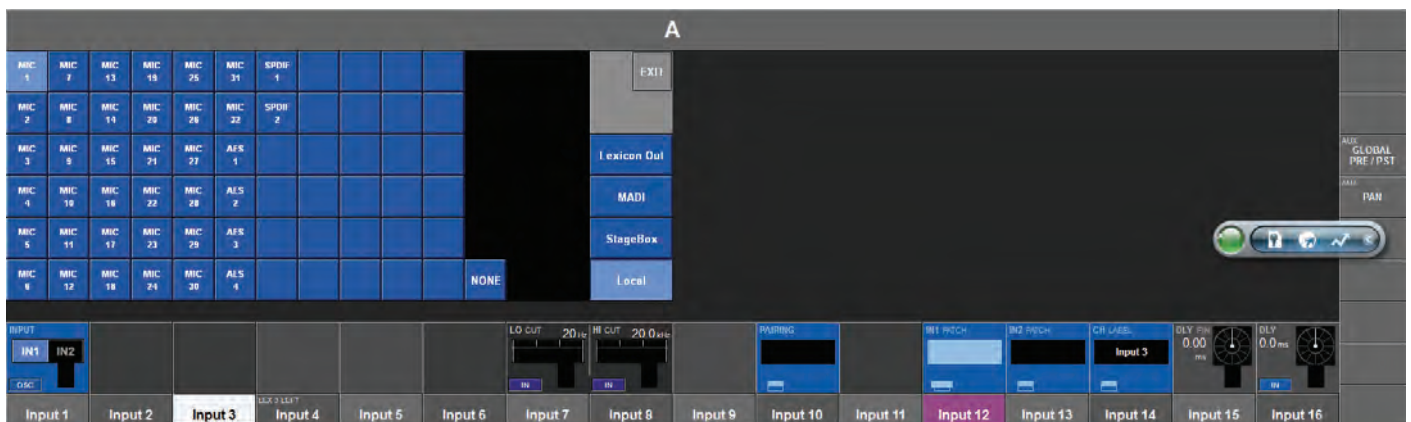

Input Patch Point can be set individually for both possible Inputs IN1 and IN2, using the IN1 PATCH and IN2 PATCH configuration button.

IN 2 can optionally be used for the > SPARE MIC function.



The small blue A/B legend in the Channel Label area shows which other channels use the same signal, where A means this channel on the Input Layer A and B means this channel on the Input Layer B.

Patch A Source To An Input Channel

- * Press the Input field of the desired Channel
- * Press the IN1 or IN2 Patch button
- * Select the desired Input Source -> Audio will immediately patched
- * Leave the Patch page by pressing the IN1 or IN2 Patch button again, or the Exit button on screen.



HINT: It is possible to select NONE, that means no audio source is patched to this INPUT. Location groups (e.g., Stage box, Local I/O etc) can be changed by directly selecting the required group on the right-hand side of the screen.



HINT: If the channel is paired, <LEFT> and <RIGHT> comes up and allows toggling between the input patch for L & R of the paired channel.

Using A Spare Mic For Several Inputs

Figure 10-4 shows four mics patched to four input channels via each channel's IN1 patch. The spare mic is patched to all of the 4 channels via their IN2 patch. In the event that one of the main mics fails it is easy to change the appropriate channel's input from IN1 to IN2.

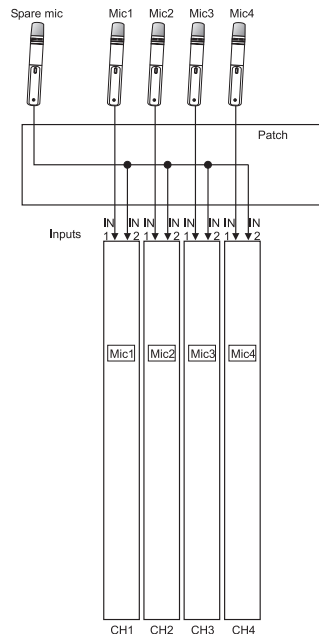

OUTPUT

The Output Patch connects a master or bus out with an output connector or MADI channel. A master or bus out signal can be patched to several physical outputs at the same time.

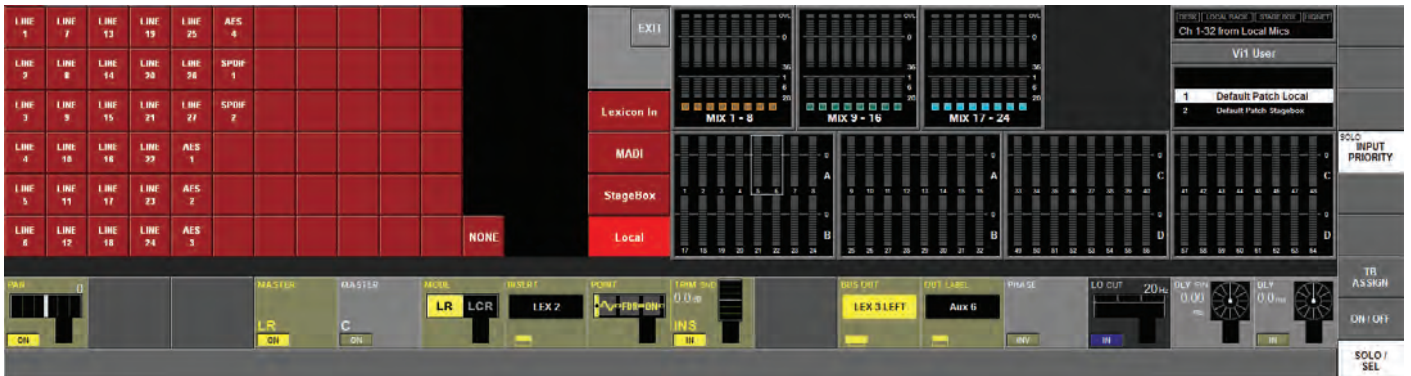

Patch a BUS to an OUTPUT

There are two ways to access the Output Patch configuration page. They are summarised on page 10-2.

As an example of one of the two methods proceed as follows:

- * Press one of the output fader page keys [A]-[D] on the master bay.
- * Ensure that no Setup or Menu pages are open (other than 'MAIN Menu').
- * Press the [SOLO/SEL] key for the bus to be assigned to an output (or press the [SEL] key under the LR C faders to assign any of the three main output busses).
- * Press the PAN area on the master section touch screen (this is in the area that the input meters were being displayed).
- * Press the {BUS OUT} Patch button.
- * Select the required output on the touch screen.
- * Optionally select additional outputs.
- * Leave the Patch page by pressing the OUT Patch button again, or the <EXIT> button on screen.

The second method is to select the [BUSSES 1-16] or [BUSSES 17-24] fader pages and access the PAN area for the required output directly on the input fader screens.)



HINT: It is possible to select <NONE> to reset the patch.

Location groups (e.g., Stage box, Local I/O, etc) can be changed by directly selecting the alternate groups.



HINT: If you adjust a STEREO Bus the desired patch page can be selected with <LEFT> and <RIGHT> .

INSERT

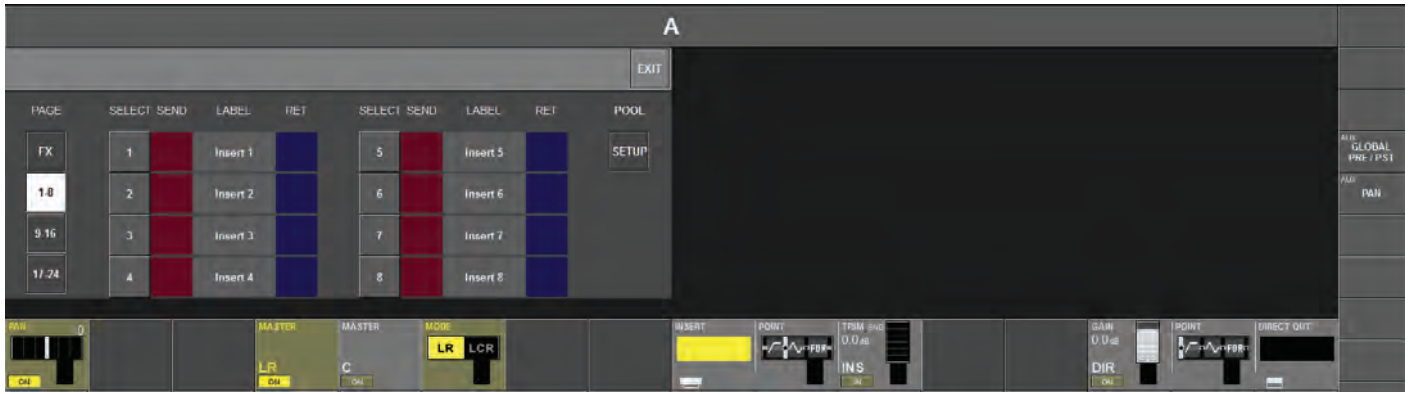

Inserts are organized within an Insert POOL that contains up to 24 insert send/return pairs.

Once set up, each insert in the pool can be easily patched to the desired Input channel or master insert point.

Patching An Insert Point To An Input Channel

- * Select the PAN touch field of the destination input channel.
- * Press the {INSERT} config screen area. The insert select page will open in the touch area.
- * Select the preconfigured insert pair of input & output connections [1]-[24] from the pool.
- * Leave the page with <EXIT> or press {INSERT} again.

Before an insert can be patched into a channel, the physical connectors or MADi channels for the send and return must be defined. A specific pair of connectors can be set up for each device, and the device name entered for easy recognition. Press <SETUP> to access the Insert Point Setup page.

Patching Insert Send Or Return Signals To The Connectors Or MADi Channels

- * <SEND> opens the output patch page, where it is possible to define the physical connector for the insert send.
- * <RET> opens the input patch page, where it is possible to define the physical connector for the insert return.
- * <LABEL> opens the keyboard page, where it is possible to label the insert.
- * Leave the page with <EXIT> or press the INSERT {VST config button} again.

Stereo Inserts

Stereo inserts can be configured odd/even wise with <LINK> from the even insert number. The following table shows the valid Format combinations.

	MONO CHANNEL	PAIRED CHANNEL or STEREO BUS
MONO INSERT	✓	X
STEREO INSERT	✓ audio is fed to both insert sends, returns are down mixed	✓

DIRECT OUT

The direct out patch connects a channel direct out with an output connector. Direct out can be patched to several outputs at the same time.

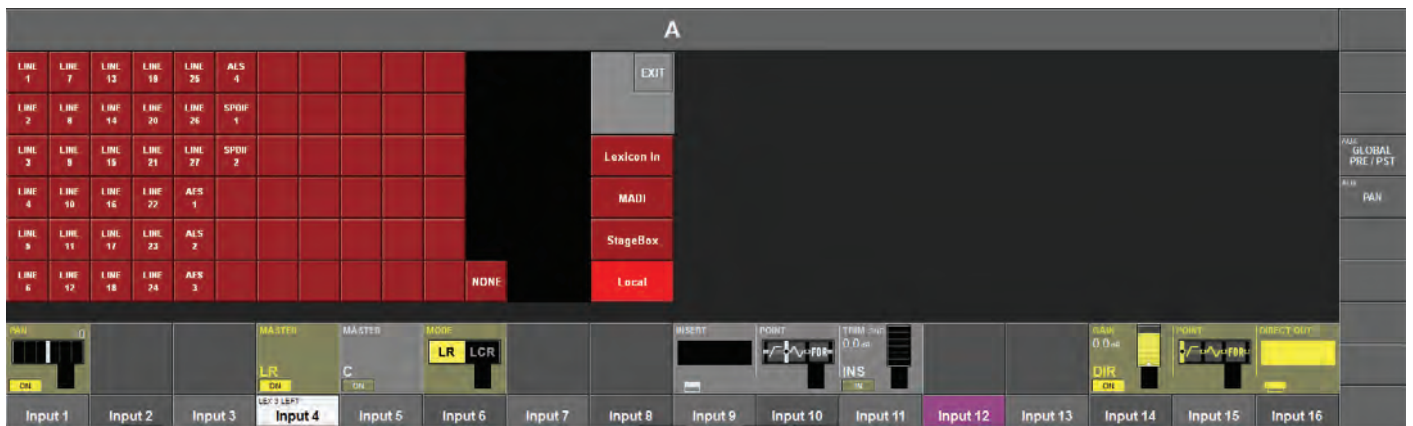

HINT: If the channel is paired, <LEFT> and <RIGHT> comes up and allows toggling between the L & R direct out patch of the paired channel.

KEY SIGNAL

The key signal patch feeds a channel direct out or an input signal from the patch to the key input of the GATE.

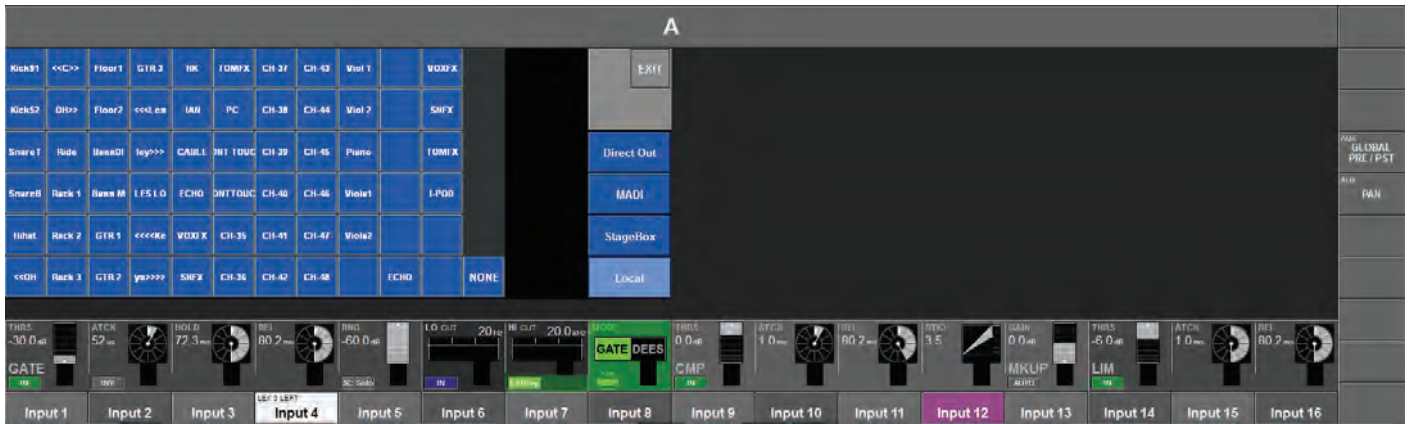

MATRIX

The matrix patch page connects a channel direct out, an input signal, MADI channel, or a master signal to become a source for a Matrix output.

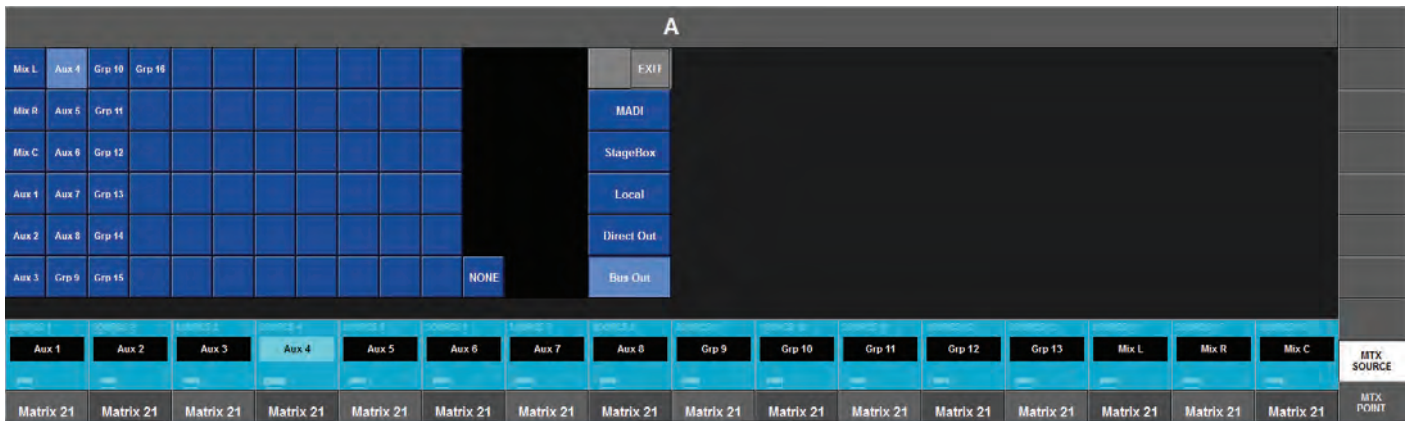

Pressing the required VST area opens the Matrix Source Patch Page.

TIE LINES

TIE Lines are direct connections from an input connector to an output connector. They are a path through the mixer with no processing and no mixing, and so do not use up any DSP channels.

To open the Tie Line Setup page press the [MENU] key, and then press the <Tie Lines> tab at the top of the master area touch screen

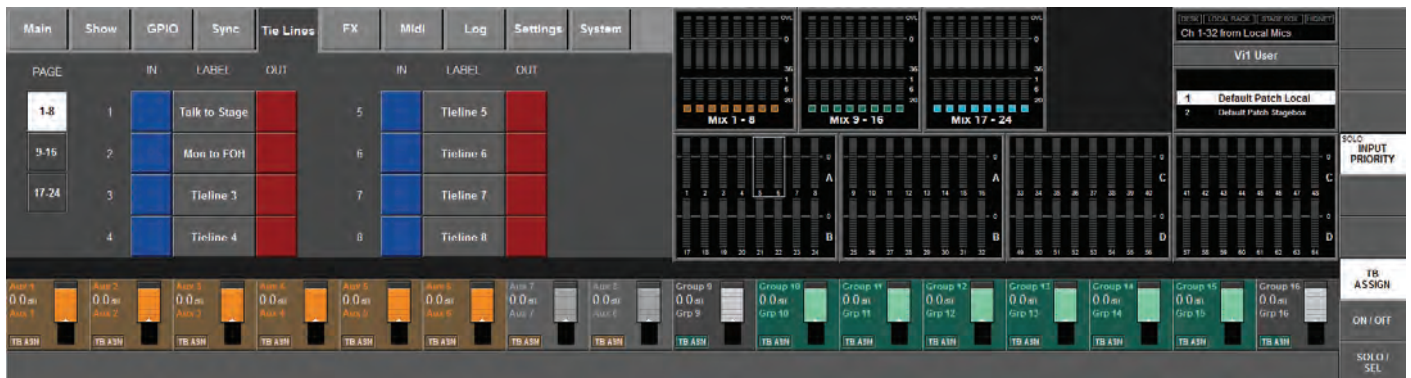

The Soundcraft Vi1™ supports up to 24 tie lines. 8 of them are arranged per page. The desired page can be chosen using the <1-8>, <9-16>, <17-24> buttons..

<IN> opens the input patch configuration page, while <OUT> opens the output patch configuration page.

Example: Send An Audio Signal From The Stage To The FOH Location

To set up a TIE line:

- * Patch the stage box input connector to a free tie line input <IN> (blue).
- * Patch the TIE line to an output connector on the Local Rack <OUT> (red).
- * Optionally re-label the tie line <LABEL>.

SIGNAL FLOW

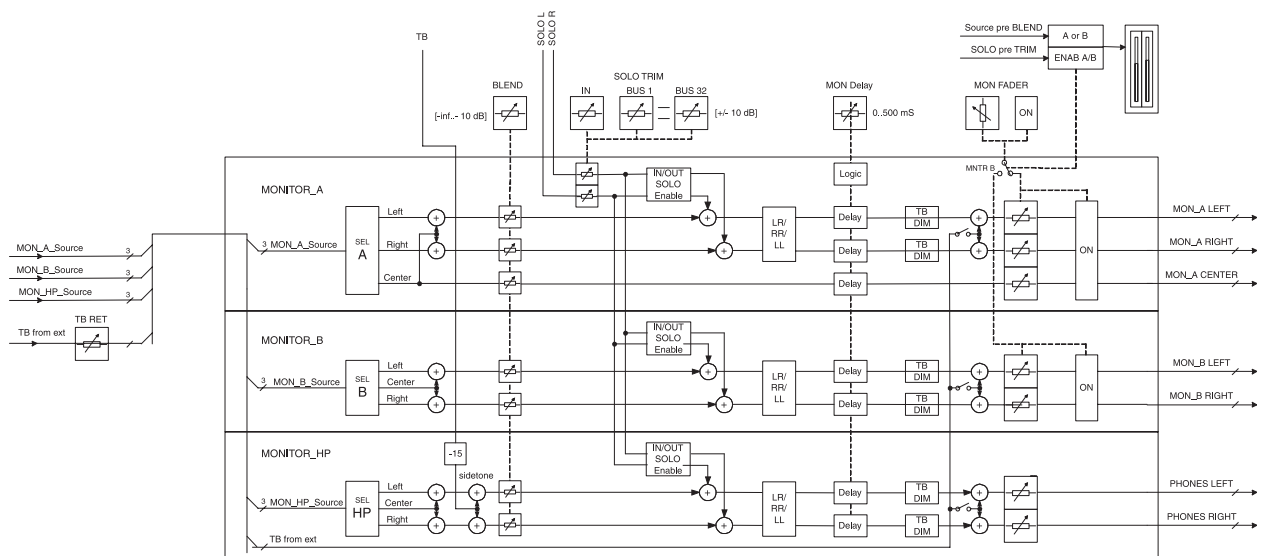

FUNCTION

The Monitoring section in the Soundcraft Vi1™ has three individual monitoring outputs:

- Monitor A 3 channel (LCR) format (it can be used as stereo by ignoring C)
- Monitor B Stereo format
- Headphones Stereo format.

For each monitoring output, the following parameters can be set or configured:

- Source
- Input SOLO
- Output SOLO (with user configurable OUT SOLO Group)
- TB from external
- Audio Format (swapping or mono-ing Left or Right channels).

Two alternative monitoring sources, USER A and USER B, can be freely assigned and labelled. These can be used for a favourite monitor mix, or a 'shout' talkback feed.

DESK VIEW

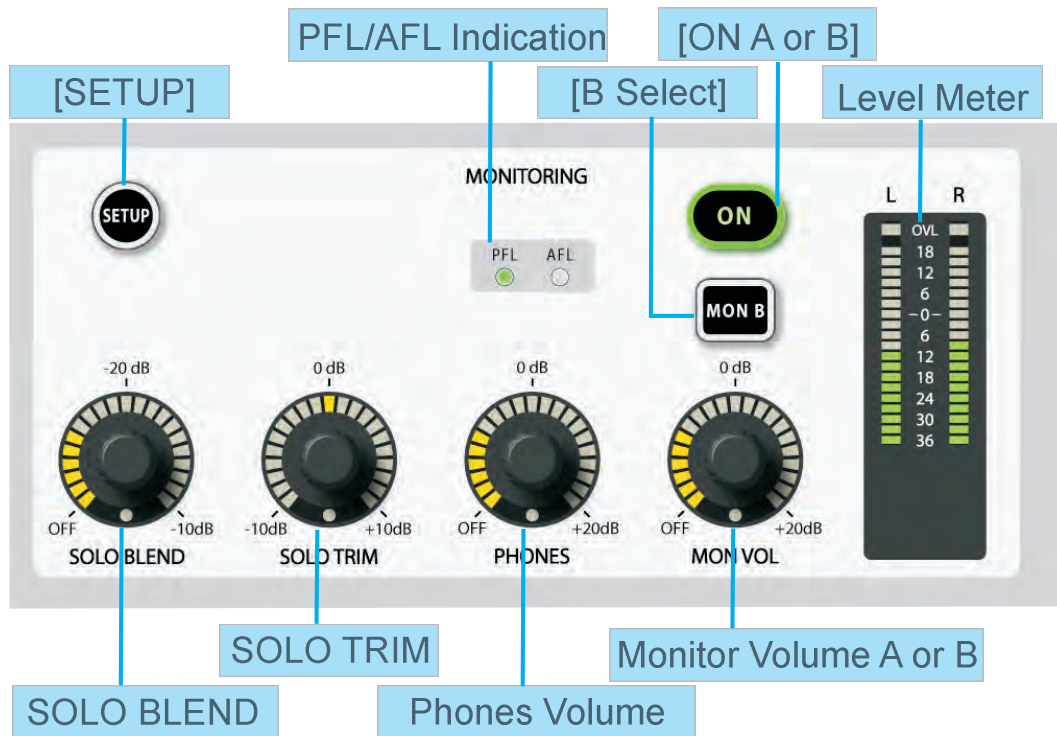

SOLO TRIM

Trims the SOLO Level in the range +/- 10 dB. This control is SOLO context sensitive. It is possible to set a different trim for each of the 32 Outputs in addition to a global input solo trim level.

SOLO BLEND

Adjusts the background level of the monitoring source signal which is audible when a solo is in operation from OFF ($-\infty$) (as normal consoles) to a -10dB dim. This allows solos to be heard within a mix which has a reduced background level.

PHONES Volume

This encoder is permanently assigned to control the headphones volume level. The headphone output socket is located under the armrest at the front of the console, and is designed for headphones with impedances in the range 50-600 ohms.

SETUP

When this is pressed the Monitor Setup Page is displayed on the master screen. The setup key glows blue when it is active.

Level Meter

The stereo Level Meter shows the level of the A or B outputs, depending upon the selection made via the Monitor B switch. The meters follow the Monitor Volume Fader.

PFL/AFL Indication

These two LEDs show if an active solo is a PFL or an AFL.

ON

This switches the currently-selected monitor (MTR A or MTR B) on.

MON VOL (Monitor Volume)

This controls the volume of the currently-selected monitor (MTR A or MTR B). Note that the monitor volume can also be assigned to the Master LR and C faders (see page 11-9).

MON B

This selects either the A or the B monitor to be displayed on the meter, to be controlled by the fader, and to be switched on and off by the ON switch.



Hint: both monitor A and B continue to operate irrespective of the selection made by the Monitor B switch.

MONITOR SETUP PAGE

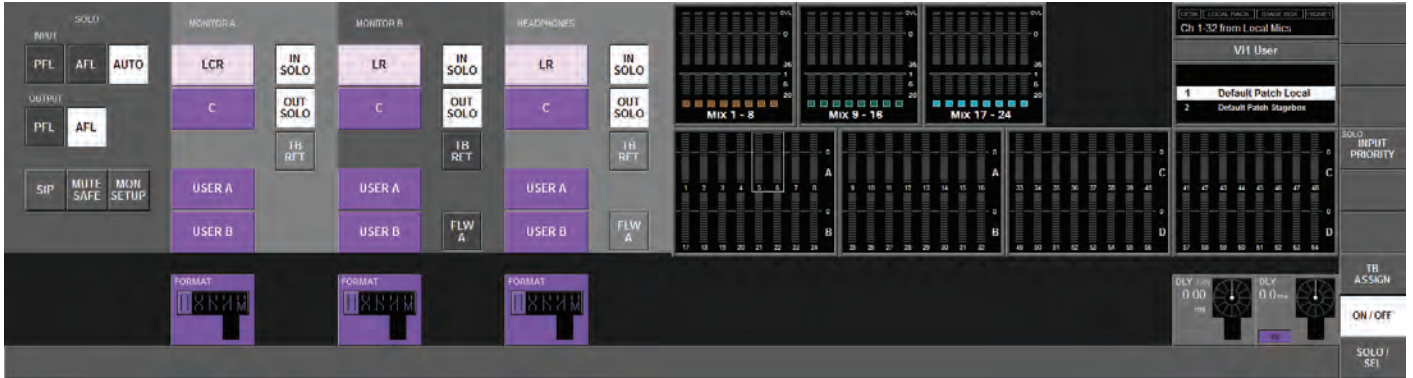

SOLO Section

Input

<PFL>

Sets the input channel solo mode to PFL.

<AFL>

Sets the input channel solo mode to AFL.

<AUTO> (default)

Sets the input channel solo mode automatically, as follows. If one Input SOLO is active the mode is PFL, if more than one Input SOLO is active at the same time the mode is AFL. (Press and hold the first input solo key to then select additional solos.)

Output

<PFL>

Sets the Output SOLO mode to PFL.

<AFL> (default)

Sets the Output SOLO mode to AFL.

Miscellaneous

<SIP>

Activates the SOLO-IN-PLACE mode. This is a destructive mode for use only during soundchecks or rehearsals. When a channel is soloed in SIP mode, all other channels are muted, so that only the soloed channel is heard, in its stereo position, at the console's mix outputs.

<MUTE SAFE>

Enables the Mute Safe (SIP isolation) configuration mode. If <Mute safe> is active the Mute safe state from the Input channels can be toggled with the Channel's SEL Key. The state for a given channel is indicated by that channel's Mute Safe LED. This configuration mode is disabled when the setup page is exited.

<MON SETUP>

Enters the monitor setup sub-page. (see page 11-8)

MNTR A Section

Source

USER A, USER B and (LCR,C) are mutually exclusive, but LCR and C can be mixed. Also none can be selected.

<LCR>

Sets the monitor A Source to LCR.

<C>

Sets the Monitor A Source to C.

<USER A>

Sets the Monitor A Source to USER A. This could, for example, be used for a 2-track return.

<USER B>

Sets the monitor A Source to USER B. This could, for example, be used for a 2-track return.

Solo Switching

<IN SOLO>

Routes the Input SOLO Signals to the Monitor A Output.

<OUT SOLO>

Routes the Output SOLO from the Busses that are included in the OUT SOLO selection to the Monitor A Output.

<TB RET>

Routes the Talkback Return Signal to the Monitor A output.

Format field

The encoder selects one of the following options to be the listening format (the icons are shown to the left of the list):



LR	left source to left monitor, right source to right monitor
RL	left source to right monitor, right source to left monitor
LL	left source to left and right monitor
RR	right source to left and right monitor
Mono	left and right source is summed and fed to left and right monitor. The Centre signal is not affected.

MNTR B and HP Sections

Source

USER A, USER B and (LR,C) are mutually exclusive, but LR and C can be mixed. Also 'NONE' can be selected.

<LCR>

Sets the monitor B Source to LR.

<C>

Sets the Monitor B Source to C.

<USER A>

Sets the Monitor B Source to USER A.

<USER B>

Sets the monitor B Source to USER B.

Solo Switching

The following four fields apply to the MNTR B and Headphones sections of the screen page

<IN SOLO>

Routes the Input SOLO Signals to the Monitor B/Headphones Output, according to which of the two possible fields are selected.

<OUT SOLO>

Routes the Output SOLO from the Busses that are included in the OUT SOLO selection to the Monitor B/Headphones Output, according to which of the two possible fields are selected.

<TB RET>

Routes the Talk Back Return Signal to the Monitor B/Headphones Output, according to which of the two possible fields are selected.

<FLW A>

Selecting this option forces the source selection for Monitor B and/or Headphones to follow the selection made for Monitor A. All the other options for Monitor B and/or Headphones are disabled when FLW A is enabled.

Format Field

Selects the listening format.

The encoder selects one of the following options to be the listening format:



LR	left source to left monitor, right source to right monitor
RL	left source to right monitor, right source to left monitor
LL	left source to left and right monitor
RR	right source to left and right monitor
Mono	left and right source is summed and fed to left and right monitor.

DLY Field

The encoder changes the monitoring delay in the range 0 - 2000 mS. {ON} enables the delay function. This parameter applies to all three monitor circuits.

The monitor delay allows the headphones and/or monitor speakers to be time-aligned to the output from the main PA system, when working at a distance from the PA speakers.

	Mon A Source Options							Mon A Audio Out		
	LCR	C	USER A	USER B	IN SOLO	OUT SOLO	TB RET	L	C	R
Normal Monitoring (No SOLO active)	✓							L	C	R
	✓	✓						L+ (C-3dB)	C	R+ (C-3dB)
		✓						C		C
			✓				don't care	USR A L		USR A R
				✓				USR B L		USR B R
Input SOLO is active					✓	don't care	don't care	The Input channel's signal is routed to the monitor, the LCR busses are configured by its status as a mono or stereo-paired channel.		
	don't care					don't care	don't care	as selected by LCR/C/USR A/USR B		
Output SOLO is active	Note that if the SOLO BLEND control is not at $-\infty$ a proportion of the normally-monitored signal will be heard during a Solo activation.				don't care	✓	don't care	The Output channel's signal is routed to the monitor, the LCR busses are configured by its status as a mono or stereo-paired channel.		
					don't care		don't care	as selected by LCR/C/USR A/USR B		
TB Return is active					don't care	don't care	✓	The TB Return channel's signal is routed to the monitor, the LCR busses are configured by its status as a mono or stereo-paired channel.		
					don't care	don't care		as selected by LCR/C/USR A/USR B		

	Mon B/H'phones Source Options							Mon B/HP Audio Out	
	LR	C	USER A	USER B	IN SOLO	OUT SOLO	TB RET	L	R
Normal Monitoring (No SOLO active)	✓							L	R
	✓	✓						L+ (C-3dB)	R+ (C-3dB)
		✓						C	C
			✓				don't care	USR A L	USR A R
				✓				USR B L	USR B R
Input SOLO is active					✓	don't care	don't care	The Input channel's signal is routed to the monitor, the LCR busses are configured by its status as a mono or stereo-paired channel.	
	don't care					don't care	don't care	as selected by LR/C/USR A/USR B	
Output SOLO is active	Note that if the SOLO BLEND control is not at $-\infty$ a proportion of the normally-monitored signal will be heard during a Solo activation.				don't care	✓	don't care	The Output channel's signal is routed to the monitor, the LCR busses are configured by its status as a mono or stereo-paired channel.	
					don't care		don't care	as selected by LR/C/USR A/USR B	
TB Return is active					don't care	don't care	✓	The TB Return channel's signal is routed to the monitor, the LCR busses are configured by its status as a mono or stereo-paired channel.	
					don't care	don't care		as selected by LR/C/USR A/USR B	

MONITOR SETUP SUB-PAGE

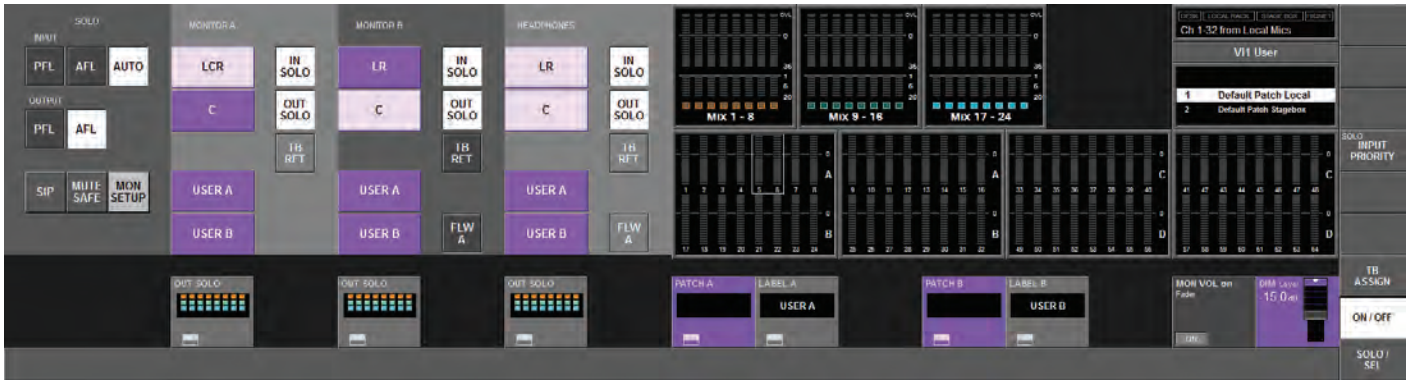

OUTPUT SOLO SELECTION

Output Solo Selection allows an individual output solo to be sent only to a specific monitor output (Mon A, B or Phones). This is useful for stage monitoring applications where the solos of in-ear monitor mixes could be programmed to appear only on Monitor B for example, which could have an in-ear headphone system connected to it. In this example, conventional wedge monitor mixes could be programmed to appear only on Monitor A when soloed, where Monitor A could be connected to a wedge speaker system.

OUT SOLO A field

Displays the Busses which are included in the OUT SOLO selection (default ALL) for Monitor A. Its VST {config button} opens the OUT SOLO Group configuration page.

OUT SOLO B field

Displays the Busses which are included in the OUT SOLO selection (default ALL) for Monitor B. Its {VST config button} opens the OUT SOLO Group configuration page.

OUT SOLO HP field

Displays the Busses which are included in the OUT SOLO selection (default ALL) for the headphones. Its {VST config button} opens the OUT SOLO selection configuration page.

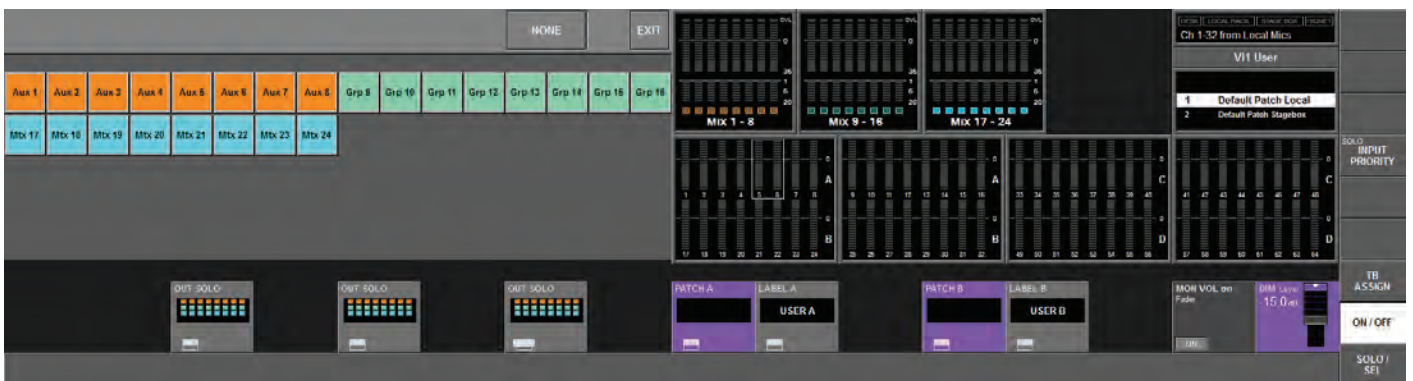

Each of the 32 outputs can be switched in or out of the output monitoring group, for each of the 3 monitoring circuits. The <NONE> key deselects all of them. <EXIT> makes the display go back to the previous page. The selections made are mirrored in the small OUT SOLO areas of the VST area. The colours indicate the type of each output: Aux Group or Matrix.

PATCH A field

Displays the source name that is patched to USER A. Its {VST config button} opens the USER A patch page (see screenshot below).

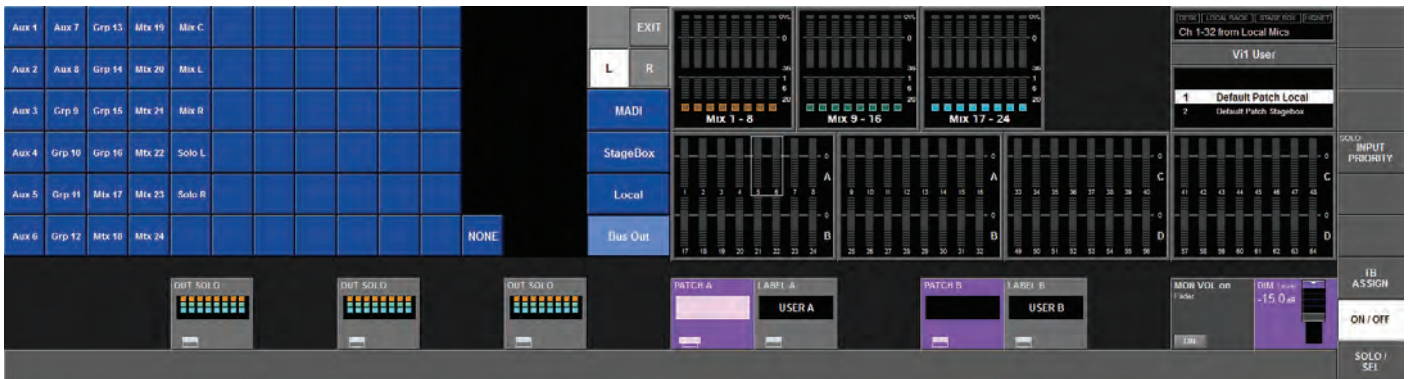

LABEL A field

Displays the USER A label. Its {VST config button} opens the USER A label configuration page, which displays the internal keyboard, and allows the USER A label to be edited.

PATCH B field

Displays the source name that is patched to USER B. Its {VST config button} opens the USER B patch page, which is similar to the USER A patch page.

LABEL B field

Displays the USER B label. Its {VST config button} opens the USER B label configuration page, which displays the internal keyboard, and allows the USER B label to be edited.

The USER A and USER B patch pages allow an alternative monitor source to the normal LR or LCR mix, to be set up.

This can be used, for example, to allow the user to listen to a favourite monitor mix, whenever a solo is not pressed (select an Aux bus from the Bus Out page, as shown above). Another application is to allow an input from the Stagebox to be used as a 'shout' talkback line: if the relevant Stagebox input is selected as the User A or B source, this can be monitored whenever no desk solos are being monitored.

The User A and User B sources are normally stereo, but a mono source can be used by patching the same source to L and R channels in the patch page shown above.

MON VOL on Faders field

Switching this function ON will assign the Monitor Vol to the Master LR and C faders so that Monitor engineers have more direct control of these. The MONITOR A volume is assigned to the LR master fader, and the MONITOR B volume is assigned to the C master fader. The Monitor Vol encoder continues to function in parallel. The LR and C signals are left at the level they had before the function was switched ON; it is not possible to adjust them in this mode.



Hint! When you load a Monitor Default show, this parameter will be switched on automatically.

DIM LEVEL field

The encoder adjusts the DIM Level between 0 and - infinity. The DIM function is only activated if the Return Talkback function is activated via the GPIO facility (see Chapter 16) or if any of the Talkback buttons (EXT, INT, PRESET 1, 2, 3) on the desk are pressed (see Section 12, Talkback & Osc).

SOLO SYSTEM

AFL ,PFL and SIP

The solo system on the Soundcraft Vi1™ comprises a non-destructive PFL and AFL Solo capability from Inputs and Outputs, and also the option of a destructive Solo-In-Place mode, for use only during soundchecks or rehearsals. Solo-In-Place mode has to be enabled from within the Monitor Setup and changes the mode of operation of the Solo System.

If Solo-In-Place (SIP) Mode is OFF

- * Soloing a single Input locally generates a PFL Solo onto the Solo Bus
- * If the Input Solo Mode is set to Auto, in the Monitor Setup page, soloing more than one Input locally (by pressing and holding the first Solo/Sel switch then pressing others) will generate an AFL Solo onto the Solo Bus from all soloed Inputs. If a single output is solo'ed, the solo will be PFL.
- * The PFL feed from Mono Inputs is independent of channel Pan, and is fed to the stereo Solo Bus as centre-panned image. If the Input is a Stereo Input, the PFL feed is left channel to left Solo Bus, right to right.
- * The AFL feed from Mono or stereo (paired) Inputs is stereo and follows the channel Pan.
- * Soloing an Output (either locally or via a VCA Master Solo) generates an AFL Solo. The post-fade Output signal is switched onto the Solo Bus.
If the Output is a Mono Aux, Group or Matrix, the signal is fed to both left and right Solo Bus equally (ie centre-panned image). If the Output is linked as a stereo pair, the signal from left and right Outputs are fed to left and right Solo bus respectively. There is no manually controlled Pan on Output Solos.
- * In all cases when SIP Mode is OFF, operation of any Solo will switch the audio onto the Solo Bus and the Monitor section will be automatically switched so that the Solo audio replaces the previous monitor source selection (if any) assuming that IN Solo and/or OUT Solo have been selected as a Monitor Source in the Monitor Setup Page.

If Solo-In-Place (SIP) mode is ON

- * Soloing an Input generates a 'destructive' SIP Solo, muting or dimming all other Inputs which are not Soloed or set to Mute Safe. Other channels which are subsequently soloed will be unmuted. The amount of dimming is controlled by the SOLO BLEND control on the front panel.
- * Soloing an Input (or group of Inputs) by soloing a VCA Master that the input is assigned to, generates a SIP Solo on all Inputs in the VCA Group.
- * The Input signal is not switched onto the Solo Bus, and the Monitor section does not switch the Solo Bus audio to override the monitor source selection.
- * Soloing an Output generates a normal Output AFL Solo, the same as if SIP Mode was OFF. The Output signal is switched onto the Solo Bus and the Monitor section switches so that the Output Solo audio is heard on the Monitors, replacing the previous monitor source, if any.

Solo Operation Logic

Activating Solos

A Solo is activated when any Solo/Sel switch on the console is pressed, as long as the following is true:

- * Gang Mode is not active
- * VCA or Mute Group Setup Config page is not open

Clearing Solos

* All active Solos can be cleared by pressing the momentary Solo Clear switch in the Master Section of the console. This switch illuminates when any Solos are active.

* Solos can be switched off manually.

* Solos can be cleared by pressing other Solos, under the rules of the Autocancel system (see later in this chapter).



Input Priority Mode

When I/P Priority is enabled, via the Input Priority touch field, it allows an Output Solo to remain active, whilst an Input Solo is temporarily activated 'over the top' of it. When the Input Solo is activated, its audio replaces the Output Solo audio on the Solo Bus, although the Output's Solo/Sel switch remains illuminated. When the Input Solo is deactivated, the Output Solo's audio will return to the Solo Bus.

HINT: Input Priority mode is normally used by Monitor engineers, who tend to work with an Output Solo always active, but occasionally need to solo an input to troubleshoot a problem. The Input Priority mode ensures that they automatically return to the Output Solo they were listening to, after the Input Solo is deactivated.

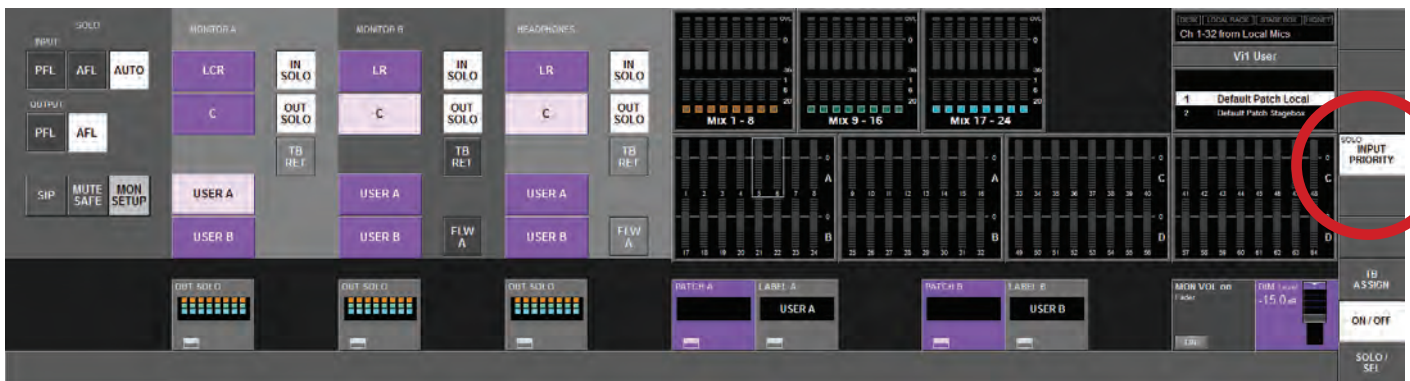

Autocancel Behaviour

In the majority of cases in live sound mixing, only one channel is soloed at any time, so it has become common practice for solos to 'autocancel' so that pressing any solo cancels the previous one, and only one solo can be ON at any time. This speeds up operation by eliminating the need to switch solos off before soloing the next channel. The Soundcraft Vi1™ includes an optimised version of this system, allowing solos to autocancel in normal operation, but also allowing the operator to select multiple solos at once if required. For this reason, there is no requirement for an Autocancel On/Off switch.

Input Priority OFF

- * Pressing any single Input or Output Solo will cancel any other active Solo of either type.
- * If an Input or Output Solo is pressed and held (whether already active or not), then one or more other Solos are also pressed, the autocancel behaviour is bypassed, and multiple Solos can be selected. Input Solos can change from PFL to AFL in this case if the AUTO mode is selected for input solos, in the Monitor Setup page. Pressing any Solo after the first Solo is released will cancel all the active Solos.

Input Priority ON

- * Pressing any single Input Solo will cancel any other active Input or VCA Solo(s), and will temporarily override (but not cancel) any active Output Solo(s), as described above.
- * Pressing any single Output Solo will cancel any other active Output Solo(s).
- * The autocancelling can be defeated by holding down an Input or Output Solo and then pressing other solos of the same type. (Pressing the 'other' type of solo in this condition is ignored).

Follow Output Solo Mode

Purpose Of The Follow Output Solo Mode

The Follow Output Solo [FLW] keys allow the user to quickly identify and adjust those input channels which are making contributions to each of the 32 outputs.

There are two [FLW] keys: there is one fader key and one Vistonics™ area key. Only one key can be active at any one time (none can be selected also).

* If Follow Solo is **NOT active** for faders or Vistonics™ encoders, pressing a Group or Aux Output Solo will activate an Output Solo, and it will also display the EQ/Dyn/Misc touch screen area for the Soloed Output, on the upper-left quadrant of the screen (in the space normally occupied by the clock/menu display).

* If Follow Solo **IS active** for either faders or Vistonics encoders, pressing a Group or Aux Output Solo/Sel will work as described above, and will also switch the input channel faders or encoders to be assigned to the Soloed bus's contributing sends (equivalent to 'Fader Flip' on some other consoles).

* If a Matrix Output Solo/Sel is pressed, regardless of the setting of Follow Solo modes, the Output Solo will be activated, the EQ/Dyn/Misc touch screen for the Matrix Output displayed, and the channel faders will be assigned to the contribution levels from the Outputs to the Soloed Matrix Output.

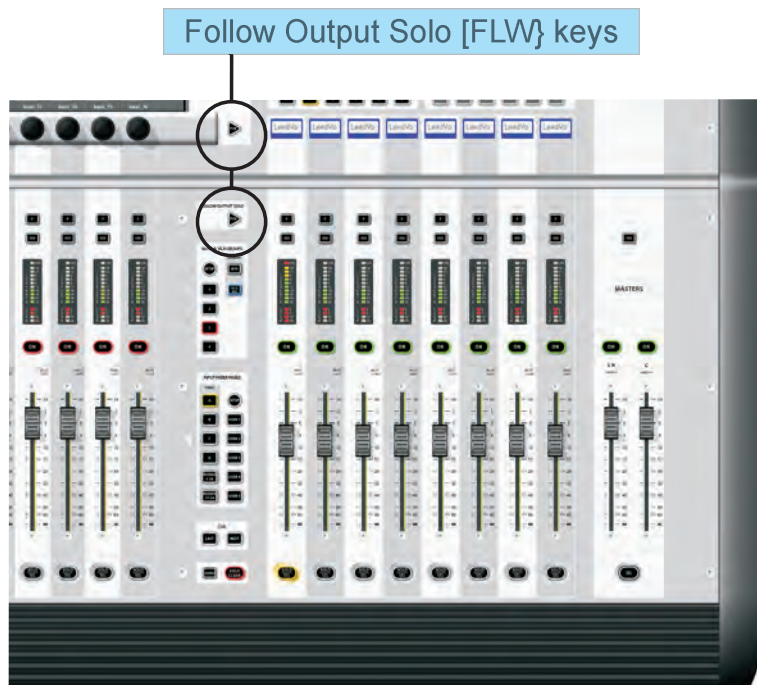

Note: the lower [FLW] key has an additional function in allowing VCAs to control the Aux sends of input channels. See chapter 9 for details.

TALKBACK & OSCILLATOR

DESK VIEW

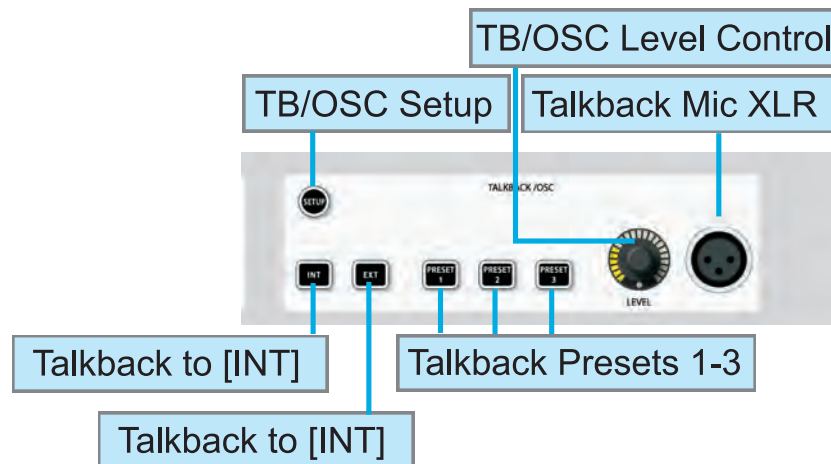

Setup Key

The [SETUP] key opens and closes a dedicated Config page on the Widescreen Vistonics™ output section, allowing control over the following Talkback and Oscillator functionality: Mic gain and routing destinations for the three preset buttons, routing of return TB to busses and/or phones; Oscillator waveform, freq, mode and routing.

The remaining controls on the front panel are for the talkback system only.

TB Mic XLR

There is 1 mic input on the front panel of the console. The switch for phantom power, if it is required, is on the rear of the console.

TB /Osc Level control

This front panel encoder gives real-time control of TB or Osc level. For Talkback, the analogue Mic Amp gain is variable from 46-66dB by an internal variable preset which is located on the pcb that is located inside on the base of the console. This is set by default to a mid-range setting. If the Oscillator is active, the control adjusts the Osc level to all destinations. The level setting is stored independently for TB and Osc.

Routing the TB signal

The following keys route the internal TB mic (or other TB source) signal.

INT

The TB signal is routed to preselected output busses. Output busses are selected via their {TB} VST keys in the VST area of the master section. The {TB} keys are enabled by selecting the [TB ASSN] touch field which is located to the far right of the master screen's VST area. The output busses are displayed in two ranges, 1-16 and 17-24, which are controlled via the [PAGE A] and [PAGE B] keys (see Figure 7-6).

EXT

The TB signal can be routed to any output on the console local I/O, Stagebox or MADI interface.

PRESET 1 - 3

Presets 1-3 are user-programmable press-to-talk (momentary & latching) switches which talk directly to specified outputs.

SETUP

[SETUP] opens the configuration page, which contains the central oscillator and the Talkback Send and Talk Back return configuration of the Soundcraft Vi1™

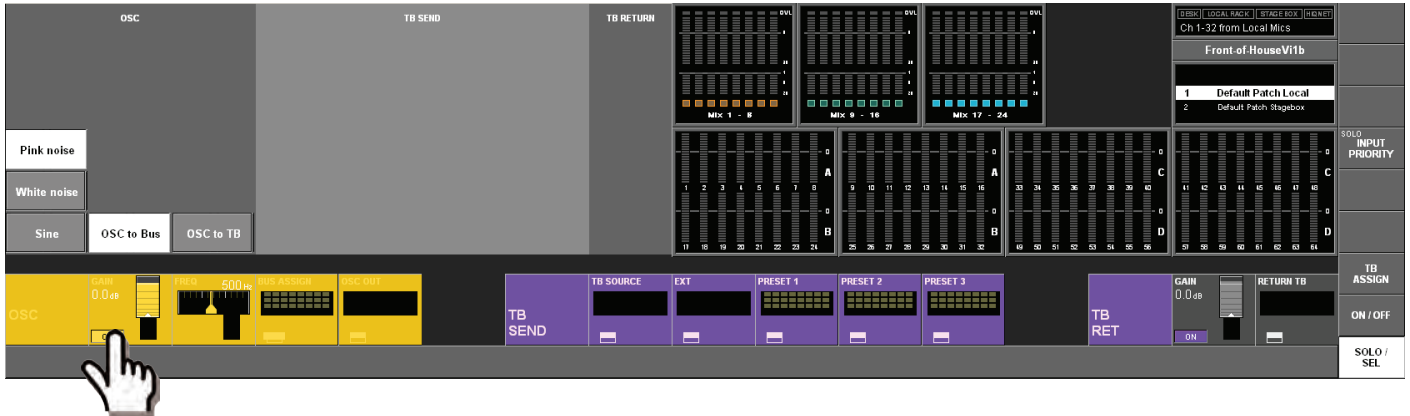

OSC Section

HINT: The oscillator can also be patched to the Input Channels by using the {OSC} key in the Input Channel VST screen.

<PINK NOISE>

Sets the waveform to pink noise.

<WHITE NOISE>

Sets the waveform to white noise.

<SINE>

Sets the waveform to sine.

<OSC to BUS>

Feeds the Oscillator to the preconfigured Busses, which are selected in the Bus Assign page.

<OSC to TB>

The oscillator signal is routed to the TB Bus and replaces the TB signal.

GAIN field

Encoder adjusts the oscillator level in the Range - inf to +18 dB. {ON} enables the oscillator.

FREQ field

If the oscillator is set to SINE the Encoder adjusts the Frequency in the range 20 Hz - 20kHz.

BUS ASSIGN field

Its {VST config button} opens the Buss Assign page.

OSC OUT field

Its {VST config button} opens the output patch configuration page

OSC BUSS ASSIGN field

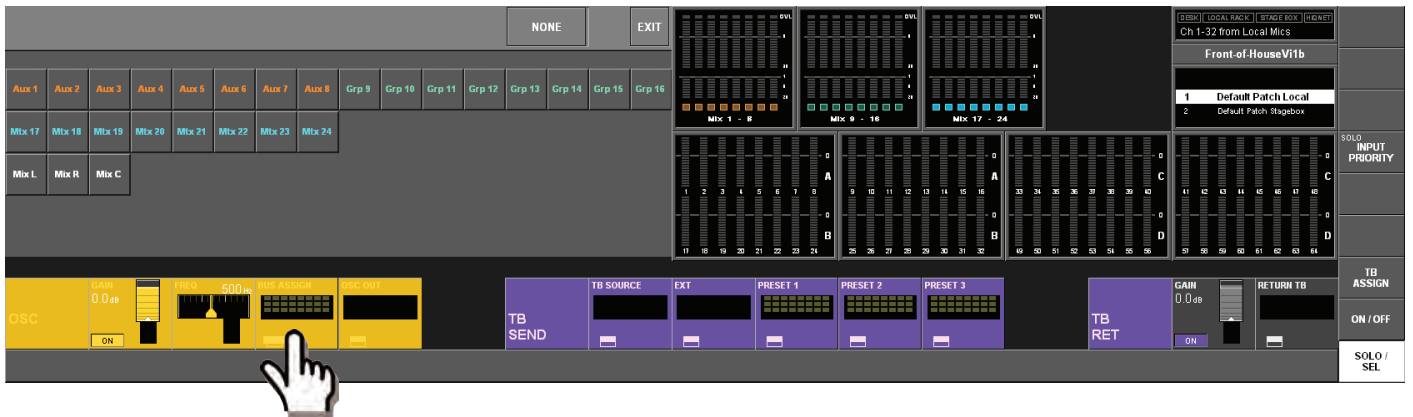

OSC OUTPUT field

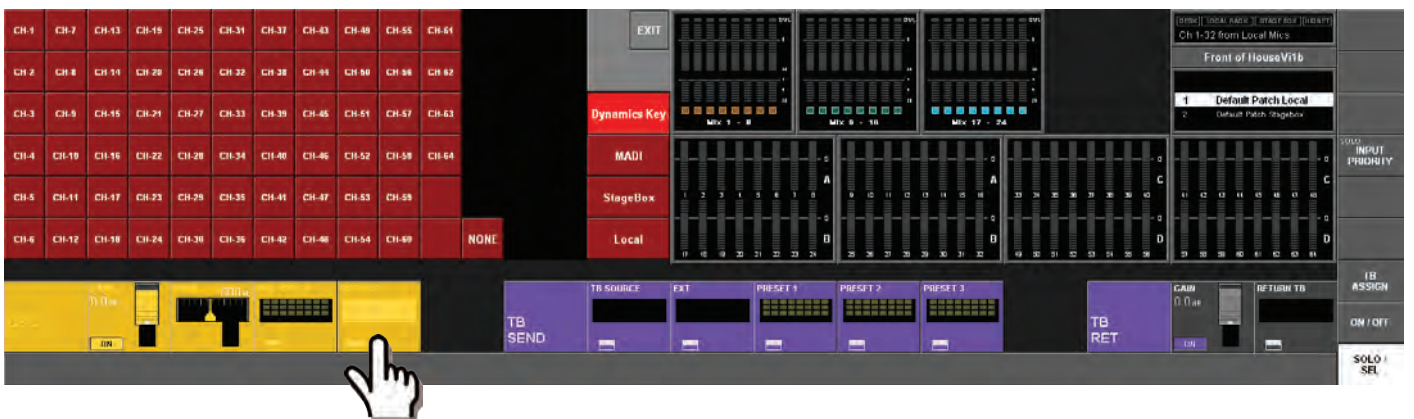

This page allows the user to patch the oscillator to outputs on the StageBox and the Local Rack, to MADI channels, or to the key inputs of the dynamics units on the input channels 1-64.

The user selects the appropriate screen by selecting one of the following touch screen buttons: <Dynamics Key>, <MADI>, <StageBox> or <Local>.

TB Send Section

This section allows the console operator to route the TB mic signal to various outputs of the Soundcraft Vi1™.

TB Source Field

Displays the source name. If nothing is selected the console's TB mic XLR is automatically selected. Its {VST config button} opens the TB source patch configuration page.

HINT: Sources can be the internal TB Microphone or any Microphone Input from the Soundcraft Vi1™. Select <NONE> to select the console's TB microphone XLR socket.

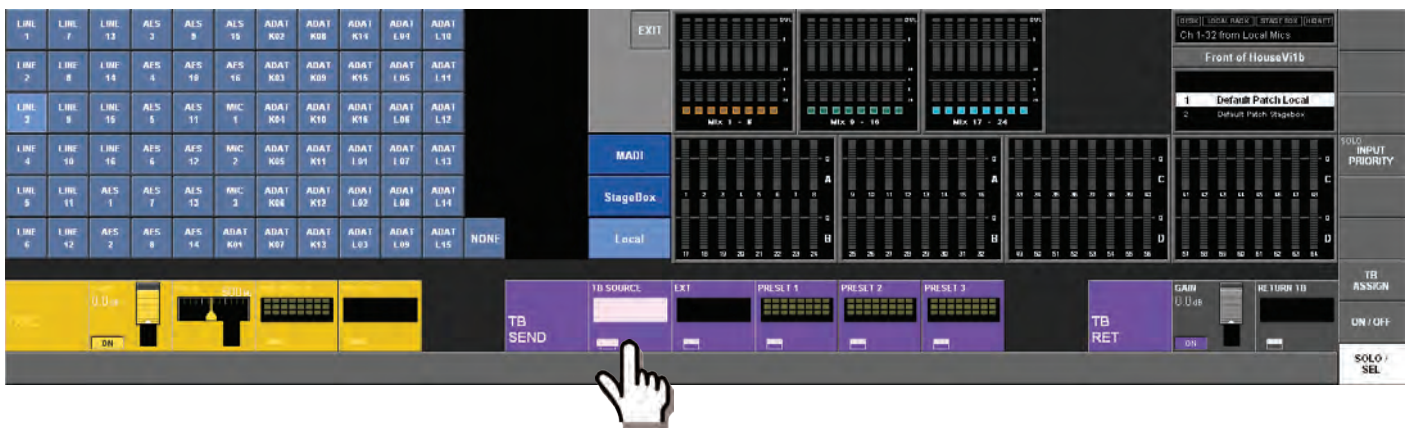

Ext

The {VST config button} opens the patch configuration page (see Figure 12-6). This allows the user to select which output will be used when the [EXT] key on the front panel is selected.

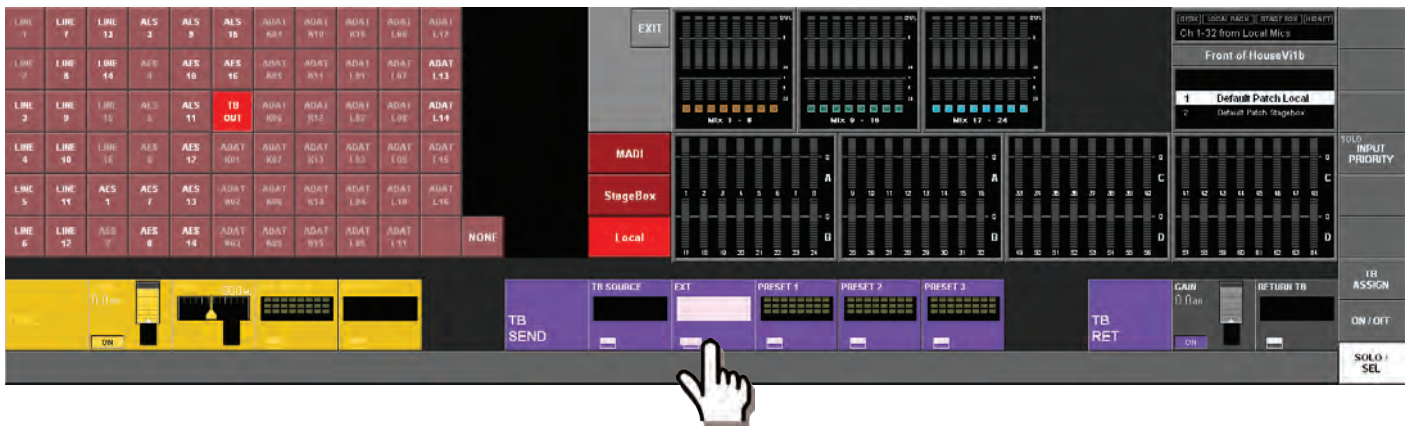

Preset 1 – 3 Fields

Their {VST config buttons} opens the configuration page to setup the preset patches to the Busses.

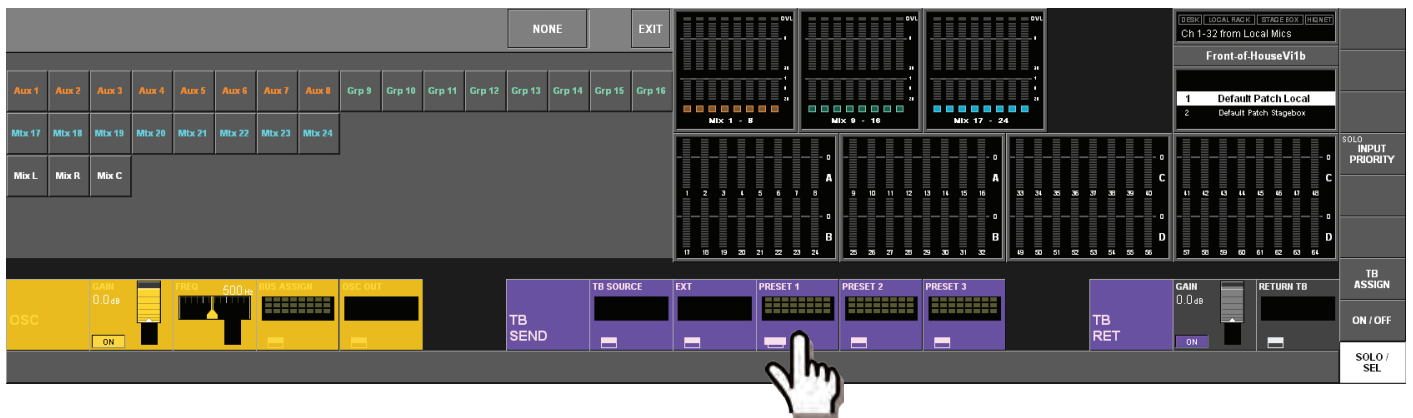

TB Return Section

This section allows the console operator to route inputs directly into the monitor circuit. This allows assistants within a venue to talk directly to the console operator. This function must be enabled via the **monitor setup** page (page 11-5).

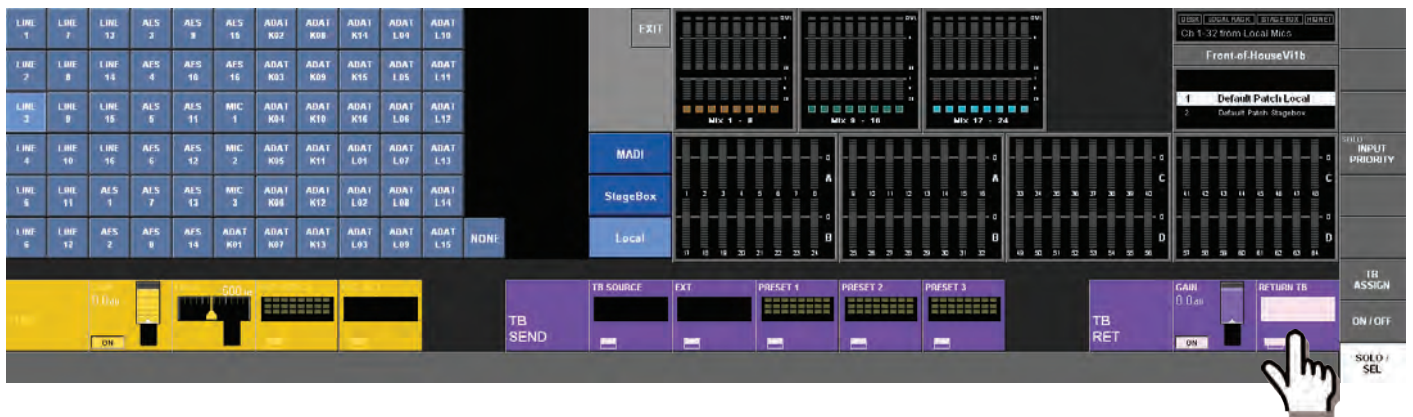

Gain

Encoder adjusts the TB return signal level. {ON} enables the TB return.

Return TB

Its {VST config button} opens the patch configuration page to choose the physical connector that will be used for the TB return signal.



Hint! : Choose a Stagebox mic input as the Return TB source, in order to provide communication from remote engineers.

Input Channel Meter

Each input channel has an input meter. There are two parts to the meter (see Figure 13-1): The top part is a 10-segment level meter, and the lower part is a 4-segment Gain Reduction Meter (GRM).



The level meter shows the input level at a selected point in the input channel. The point at which the input meter measures the signal within the input channel can be globally set via the Settings page, there are four options (see below). This page is accessed by pressing the [MENU] key, and then pressing the <Settings> tab.

If two channels are vertically paired, the meter shows the higher of the two values.

The GRM shows the overall gain reduction of the limiter and compressor, if they are engaged.

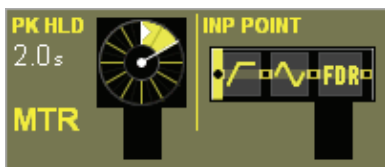
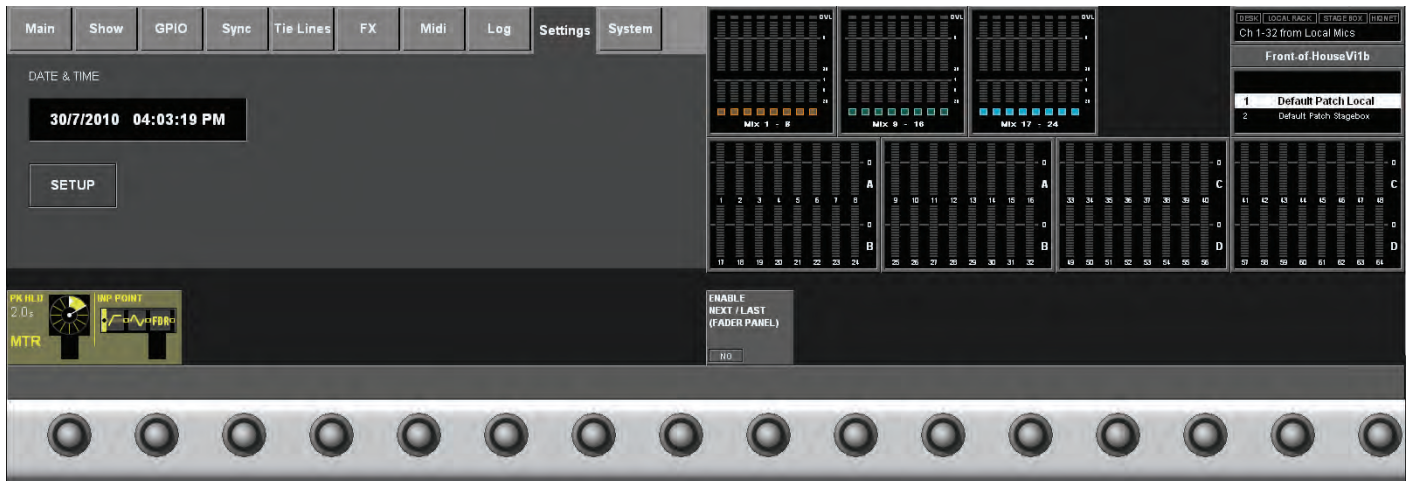

The Meter Point is after the analogue mic gain section, but before the digital trim and filters.

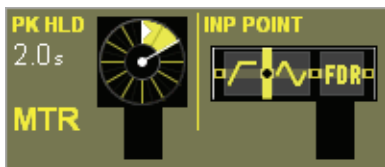

The default setting. The Meter Point is after the digital trim and filters, but before the Gate/EQ/Dynamics.

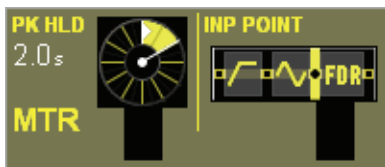

The Meter Point is after the Gate/EQ/Dynamics, but before the fader.

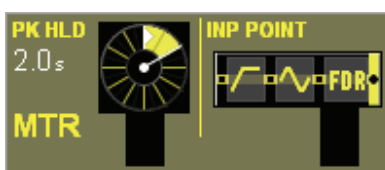

The Meter Point is post-fader.

Bus Master Meters



The GRM shows the overall gain reduction of the limiter and compressor, if they are engaged.

Master Output Meters

The L,R and C Output Masters each have a Level Meter and a Gain Reduction Meter. The L and R masters share a stereo meter.

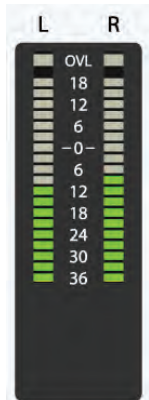
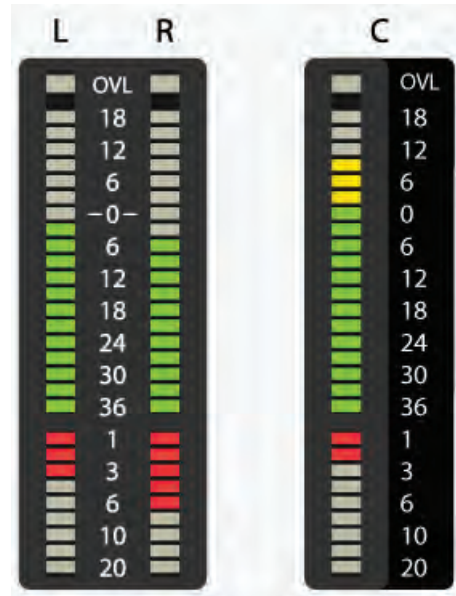

Monitor Meters

The monitor section has a stereo level meter, but there is no GRM associated with the monitor.

Scale

The Level meter scale goes from +18dB to -36dB, the actual output level in dBu from its analogue line output will be 4dB higher. Gain reduction is displayed in the Range 2 - 20 dB.



HINT: The Soundcraft Vi1™ contains full floating-point calculation, which means that the audio signal inside the mixer cannot be overloaded. If the signal level is too high at the master output meters, it is necessary only to pull down the master fader level until the correct level is obtained.

In the Input Channel meters, the overload (OVL) LED indicates an overloaded analogue input (mic preamp clipping), while in the Master meters the overload indicates a value that is higher than Full Scale (analogue output-stage clipping).

Meters On The Master Section Screen

The upper region shows all 24 Bus levels, while the lower part shows all 64 input levels. To enhance the overview, the input levels are split into four rows that correspond to the Channels in Fixed layer A (1-16) and Fixed layer B (17-32), and C (33-48) and D (49-64).

Stereo Busses are indicated by the two meters being joined at the lower end of the bar. Paired Input channels are displayed with a white border, showing either horizontal or vertical pairing.



Peak Hold

All Meters (LED Meters on the Surface and the Screen Meters) offer a PEAK HOLD function with auto release.

The Peak Hold time (same for all Meters) is currently fixed is adjustable via the PK HOLD encoder in the 'Settings' page.

Ballistics

The metering ballistics for all level meters is according to the PPM (peak program meter) DIN standard, with the difference that the attack time is audio sample based (20.8 μ S @ 48 kHz) and has no integration time.

The GRMs have no ballistics, because they show the actual dynamics control value (with time constants according to those set by the user in the Dynamics VST page).



MAIN MENU

If the menu is not visible (e.g. because another setup button is active or an output SOLO is active), pressing the [MENU] key returns to the Main menu page and display it in the top left of the master section's screen.

MAIN

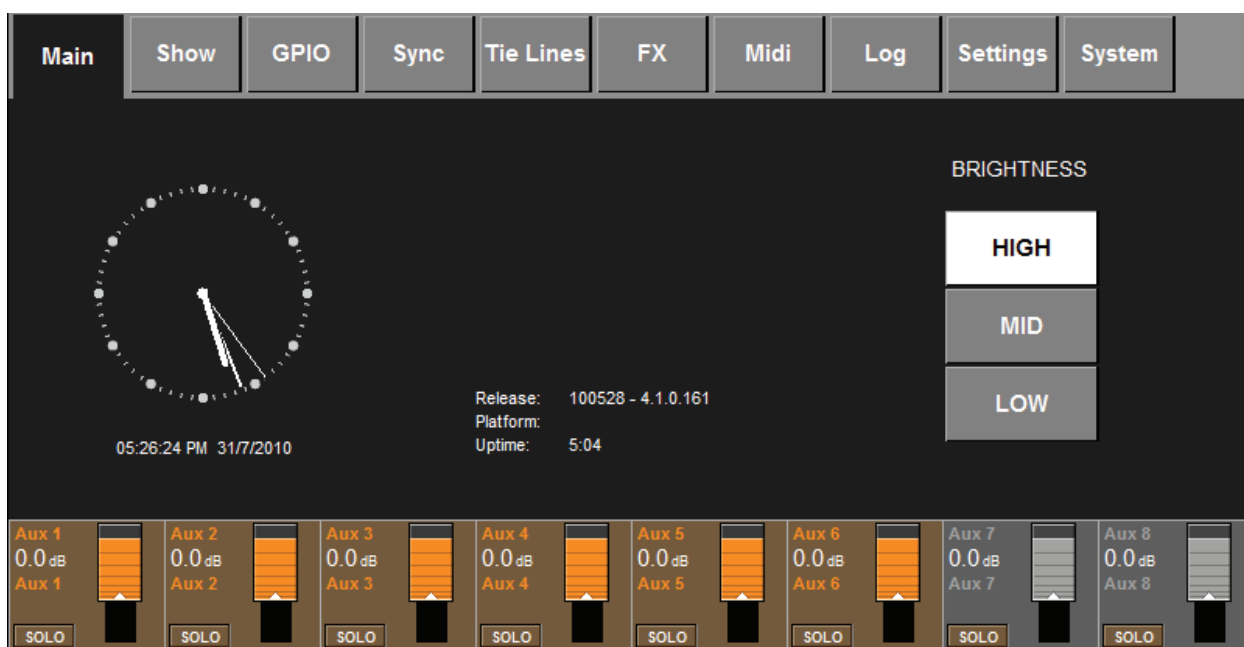

The other menu pages can be accessed by touching the appropriate tab at the top of the screen. The software Release number and Build must be quoted when requesting technical support from Soundcraft personnel.

BRIGHTNESS Control

The user has a choice of three brightness levels for the screens, illuminated keys and FaderGlow™.

UPTIME

The **Uptime** display shows the total time since the console was **originally first switched on**, not the elapsed time that the console has been in use on any particular event. This can be cleared by the user, please contact your Distributor for details.

SHOW

A complete explanation of Shows is given in chapter 15 of this manual.

GPIO

Pin	Status	Function	Parameter	Polarity	Time	Edge
IP:VGPI:FX Tap 1	0	F KEY LED	1	Positive	0	Both
IP:VGPI:FX Tap 2	0	F KEY LED	2	Positive	0	Both
IP:VGPI:FX Tap 3	0				0	Rising
OP:VGPO:FX Tap 1	0	F KEY	1		0	Rising
OP:VGPO:FX Tap 2	0	F KEY	2		0	Rising
OP:VGPO:FX Tap 3	0				0	Rising

A complete explanation of GPIO usage is given in chapter 18 of this manual. GPIO is only available when the optional Vi6 Stagebox is attached.

SYNC

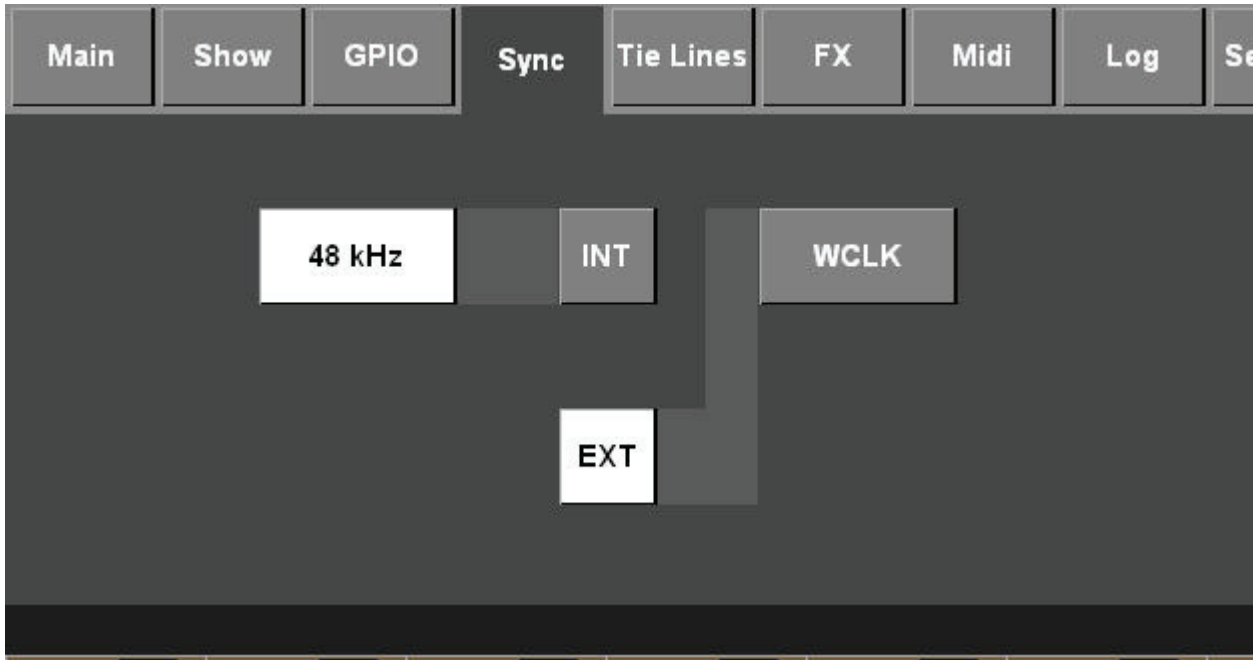

Currently the console works with an internal clock of 48kHz.

If an external clock is connected to the WCLK IN BNC socket on the rear of the console the console will switch to external sync, and the EXT LOCK indicator LED on the rear of the console, together with the EXT WCLK indicator on the Sync Menu page, will illuminate.

In order for the console to lock to the external clock its frequency must be 48kHz +/-100ppm (+/- 0.01%).

TIE LINES



A complete explanation of Tie lines usage is given in chapter 11 of this manual.

FX



See Chapter 21.

MIDI

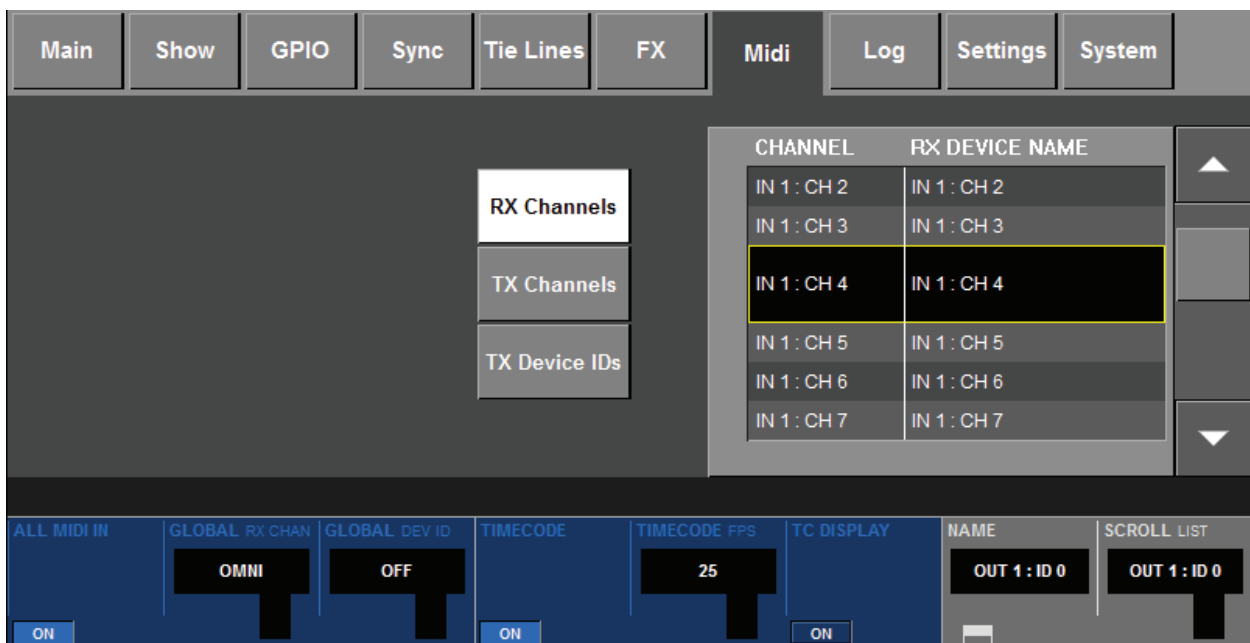

The MIDI page of the Main Menu contains the following elements :

- Device Lists for TX MIDI Channel, RX MIDI Channel and TX MIDI Device ID.
- Global MIDI Receive Channel, On/Off and Global Receive MIDI Device ID
- Global MIDI Transmit Channel and On/Off switch.
- MIDI Timecode RX global On/Off switch and Frame Rate control.

Further information is given in Chapter 21.

LOG



This page displays any errors which have occurred since the console was last powered-up. These would usually be communications errors between the various components in the system, i.e. control surface, local I/O and stagebox (if fitted).

The arrow buttons allow the user to scroll up and down the list.

The <Expand> button displays 3 lines of text for the currently-selected message, the <Compact> button replaces <Expand>.

The <Auto Scroll> button causes the most recent message to be displayed as the currently-selected one.

The <Clear> button clears the log.



Hint: The most recent message is also displayed at the top right of the master section's main screen, in the Error Log Display Area (see Figure 14-11). The message is cleared from the main screen after the Log page has been viewed by the user. Note that the Log page can be reached as described above, or by touching the Error Log Display Area on the main screen.

SETTINGS

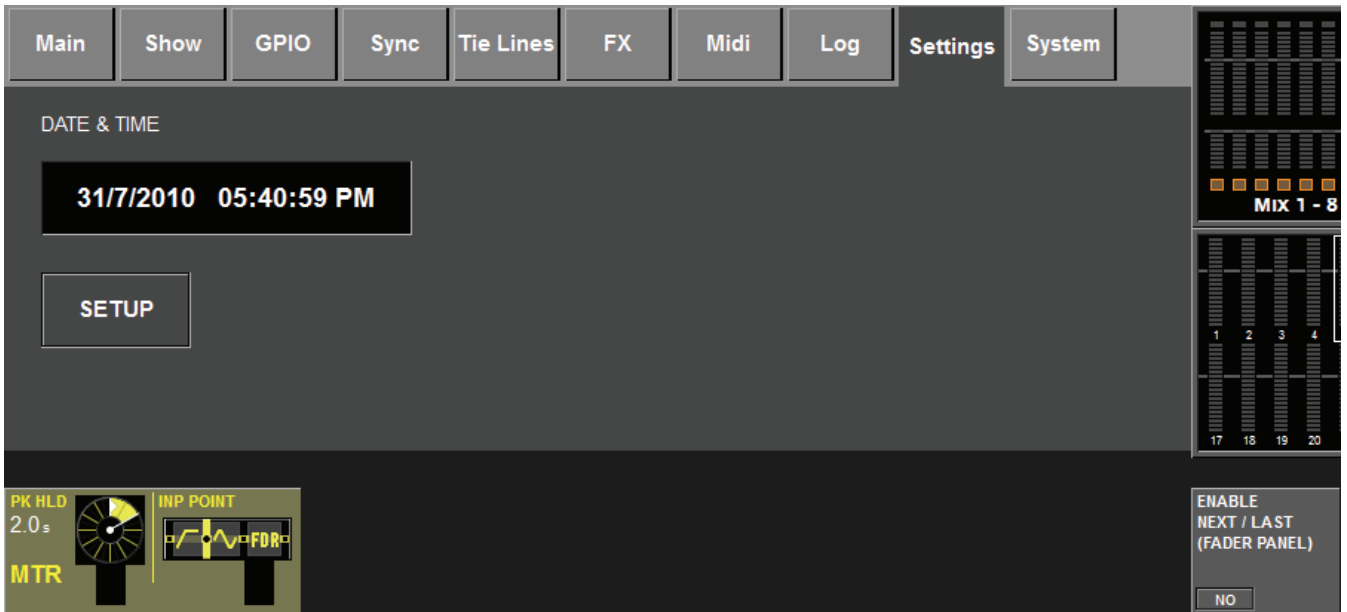

This page contains the general settings of the console.

POINT

The point at which the input meters measure the signals within the input channels can be globally set via the {INP POINT} encoder. There are four options, described in Chapter 13, Meters.

ENABLE NEXT/LAST

The [NEXT] and [LAST] keys are duplicated near the front of the desk, above the [SOLO CLR] and [GANG] keys. For safety these duplicated keys are normally not enabled, and have to be switched on via the {NO/YES} key. Once the keys have been enabled this will be stored when the show is saved.

DATE & TIME

The current date and time are displayed, this information is also used to timestamp the console's show files when they are created and/or saved. The {SETUP} button allows the date and time to be edited, as well as allowing a choice of different date formats and 12 or 24 hour time format.

SYSTEM MONITORING

Overview

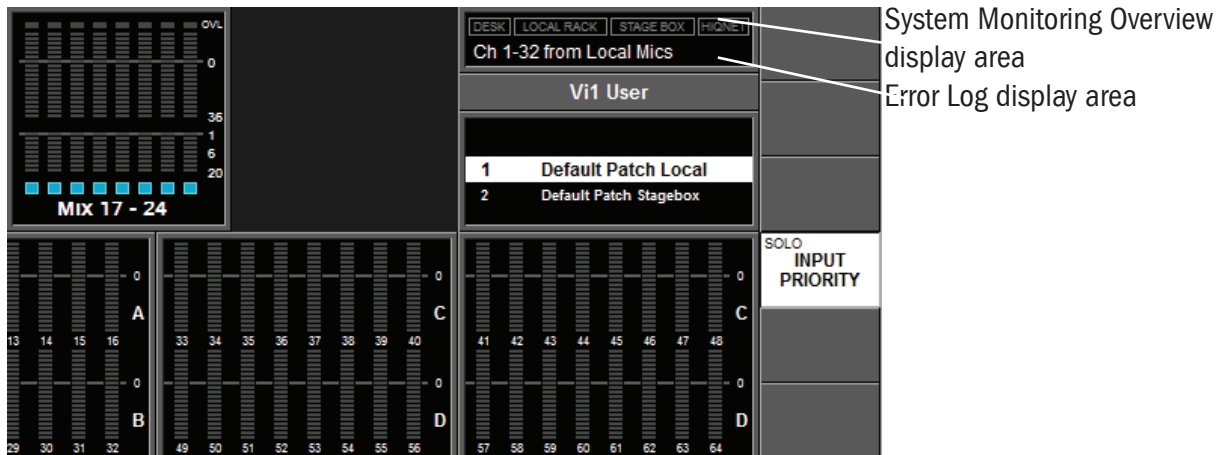

The System Monitoring Overview Display Area is located at the top right of the master screen, the Error Log Display Area is just below it.

Within the System Monitoring Overview Display Area each hardware device and the HiQnet™ network state is represented with a coloured label. The label colour indicates the overall state of the system monitoring page. A green label indicates that this device is running correctly, whereas a red label indicates an error condition.

Error and warnings are displayed in the Error Log Display Area.



HINT: in addition to accessing the System page by pressing [MENU] then <System>, the user can also touch the System Monitoring Overview Display Area.

When the System page has been opened, there are 4 sub-pages which are accessed via the touch-pads on the right hand side: DESK, LOCAL I/O, STAGE BOX and HiQnet™.

SYSTEM MENU - DESK

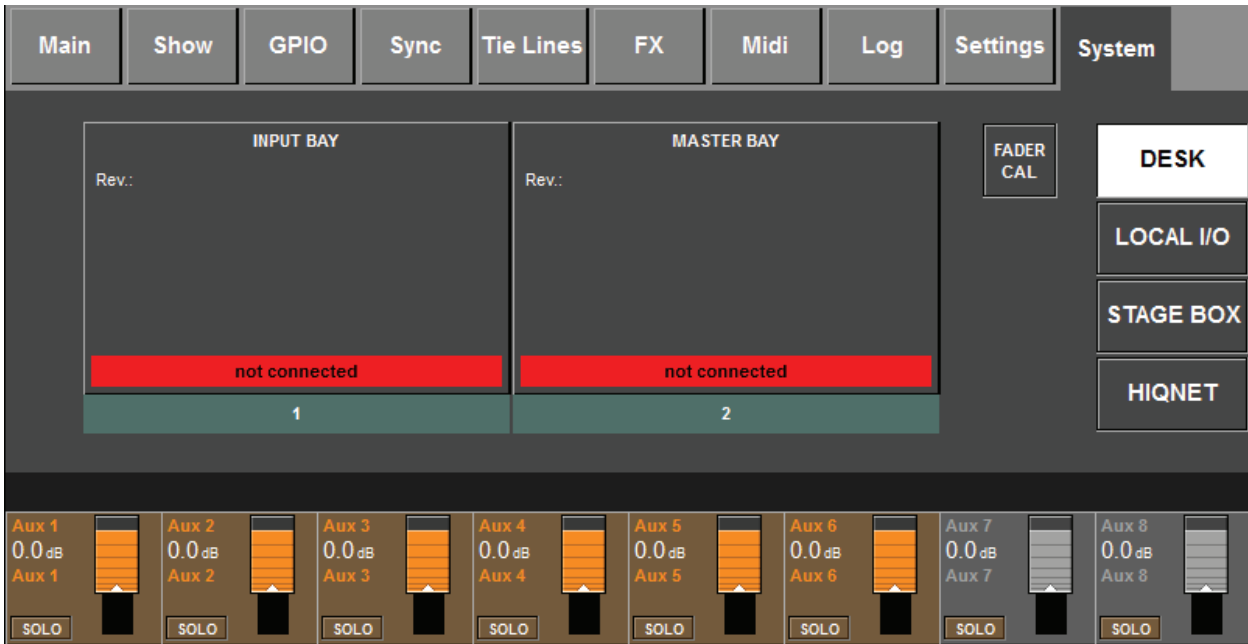

This page displays the current status of the desk's bays.

The numerical data displayed for each bay gives the revision number of the firmware currently installed in each bay. This information may be needed by Soundcraft service personnel if technical or service support is requested.

LOCAL I/O

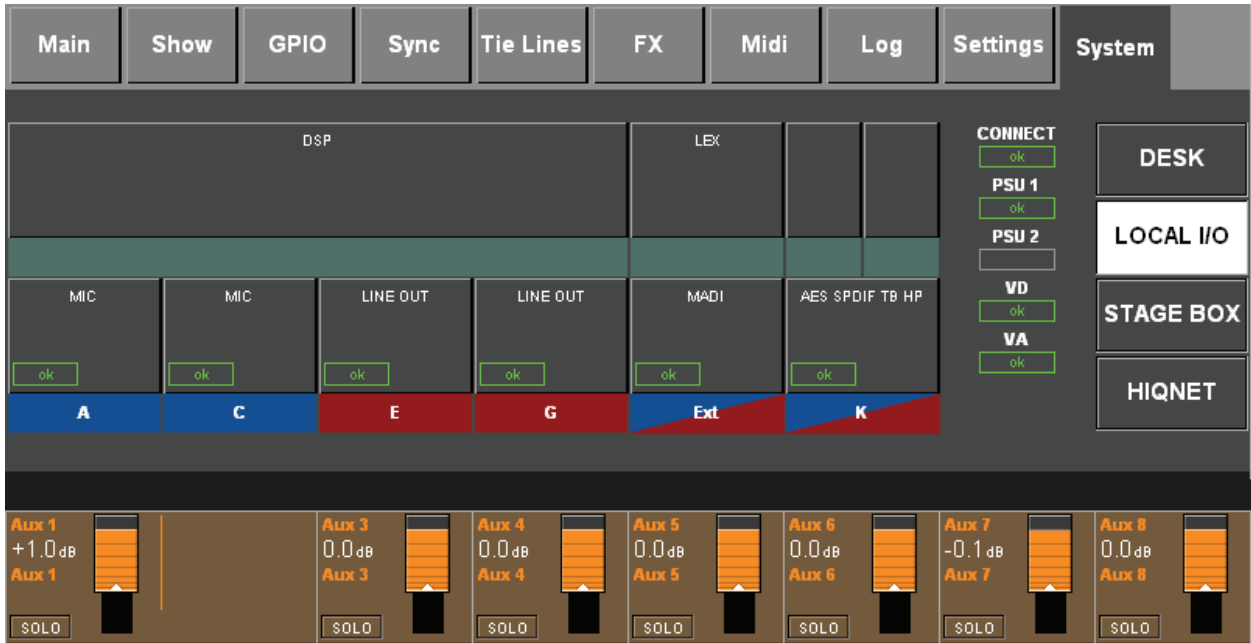

This page displays a graphical representation, and the current status, of the cards in the console. It also shows the status of the PSU(s) and the status of the voltages for the analogue (VA) and digital (VD) power supply rails. A blue label under the card indicates that it is equipped with inputs, a red label indicates that it is equipped with outputs. Some cards have both inputs and outputs, they are shown with both colours in triangles.

STAGE BOX



This page displays a graphical representation, and the current status, of the cards in the optional Vi6-type Stage Box, if fitted. It also shows the status of the PSU(s) and the status of the voltages for the analogue (VA) and digital (VD) power supply rails. The cooling fan status is also reported.

A blue label under a card display indicates an input function, and a red label indicates an output function.

If the card configuration of the Stagebox is changed (e.g., when AES input or output cards are fitted in place of the analogue cards), the card labels will be automatically updated with the new card types if the 'Reconfig' button on the Stagebox front panel has been pressed after changing the cards.

HiQNET

Main	Show	GPIO	Sync	Tie Lines	FX	Midi	Log	Settings	System
------	------	------	------	-----------	----	------	-----	----------	--------

State: **disabled**

HiQnet Address:

Serial:

IP address:



DESK

LOCAL I/O

STAGE BOX

HIQNET

HIQNET	HIQNET ADDR	IP CONFIG	IP ADDRESS				
<input type="checkbox"/>	2717	DHCP MAN	0	0	0	0	0

HiQNet {ON}

Enables or disales the HiQNet ethernet port on the rear of the control surface.

HiQNet ADDRESS

Allows the HiQNet Address for the console to be edited. Every piece of equipment on a HiQNet network must have a unique HiQNet address.

IP CONFIG: DHCP or MAN

Set to MAN if you wish to manually set the IP address for the console, or to DHCP if you wish the address to be assigned automatically by an external DHCP server (e.g. a network switch)

IP ADDRESS and SUBNET MASK

If the IP CONFIG mode has been set to MAN, the IP address and subnet mask controls allow these to be set for the console. In an ethernet network, every piece of equipment must have a unique IP (Internet Protocol) address. Devices that need to communicate with each other must be on the same subnet as each other.

Note: when changing settings on the HiQNet page there will be a delay of up to several seconds before the change is actioned. This normal, and is due to the configuration time of the internal network interface hardware.

SNAPSHOTS, CUES and SHOWS

The Snapshot system allows the user to store records of the console's settings. When a Snapshot is stored it becomes part of a Cue: a Cue contains a Snapshot and optional MIDI and GPIO/HiQnet events. These Cues can then be recalled during a performance. Cues can be deleted, copied and moved within the running order of the show.

The Cues are stored on the console's flash drive, each set of Cues is stored as a Show. The Shows can be backed up onto, and downloaded from, a USB data storage device.

Note that some of the console's settings are not stored within Cues, but they are recorded as part of the Show. These settings therefore do not change within a Show. Other settings are not recorded at all. A list of what is recorded, and what is not, is provided at the end of this chapter.

SNAPSHOT FILTERING

Snapshot filtering means the selective recall of certain snapshot parameters. The complete set of parameters is always stored, so filtering only affects recall.

There are two types of snapshot filtering: Snapshot Scope and Global Filter.

Snapshot Scope is a way of selecting the parameters which are recalled from snapshots. The Snapshot Scope is stored with each snapshot. This allows special snapshots to be created to perform specific functions, only acting on a defined part of the console.

Global Filter is stored in the Show, and affects all snapshots. It can be edited and switched on or off using the ISO buttons on the channel strips.

Global Filter is useful as an 'emergency' tool to stop some parameters from being recalled, e.g. a microphone slipping making an EQ change necessary, or a fault of some kind meaning a spare channel has to be used which has all parameters set to defaults in all snapshots.

Any snapshot recall is subjected to both these filters in series (assuming Global Filter is switched on), so if a parameter is filtered in either or both of the filters then it will not be recalled.

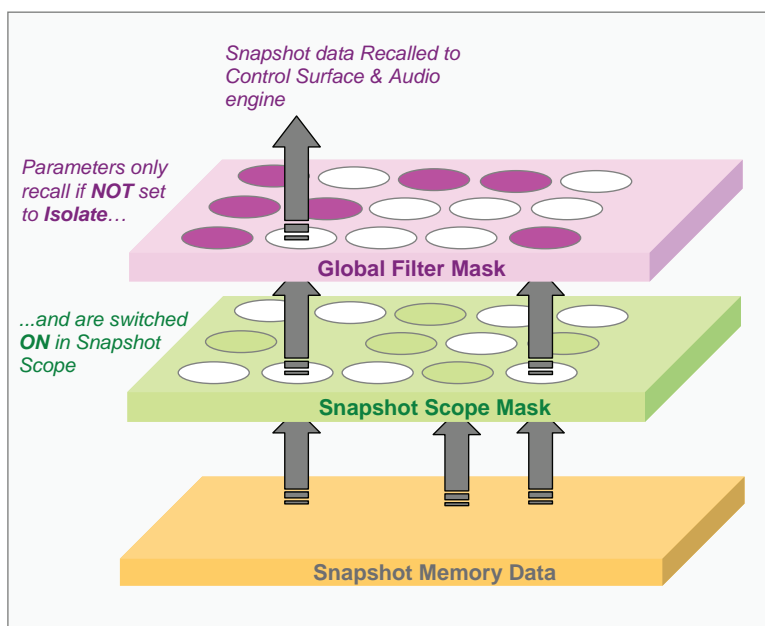

FRONT PANEL DISPLAY AND CONTROLS

The Cues of the currently-loaded show are displayed in the Cue List displayed on the upper right part of the screen. The Show's title is also displayed.



The Snapshot/Cue keys are used as described below.

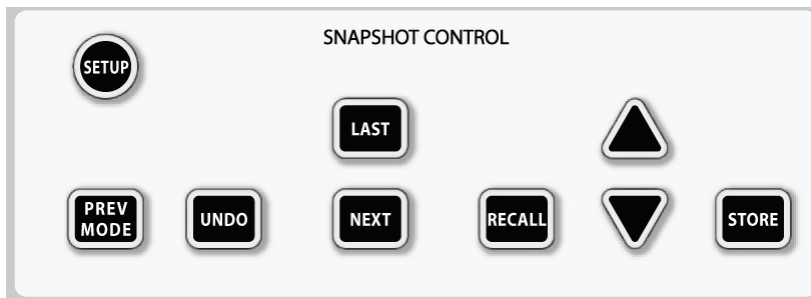

SETUP

The [SETUP] key causes the Setup page to be displayed on the master screen, see page 15-4.

DATA Socket (on main panel)

This accepts a USB data storage device.

STORE

Pressing [STORE] will record the console's current settings into a new cue.

UNDO

Pressing [UNDO] will undo the effect of pressing [RECALL], [NEXT] or [LAST]. It is useful if any of these 3 keys get pressed by mistake, and if the console's previous settings, which will get overwritten, are needed and have not yet been recorded into a cue.

PREV MODE

Press the [PREV MODE] key puts the encoder into Preview mode.

In this mode, cues can be recalled to the console surface, but without affecting any audio settings. See page 15-15 for more details.

LAST

The [LAST] key is used in conjunction with the information displayed in the Cue List. Pressing [LAST] causes any settings pointed to by the previous Cue, in the Cue List, to be loaded into the desk, i.e. the desk is configured according to the settings held against the previous Cue. This Cue becomes the current one in the list.

NEXT

The [NEXT] key is used in conjunction with the information displayed in the Cue List. Pressing [NEXT] causes any settings pointed to by the next Cue, in the Cue List, to be loaded into the desk, i.e. the desk is configured according to the settings held against the next Cue. This Cue becomes the current one in the list.

The NEXT and LAST keys are duplicated near the front of the desk, above the SOLO CLR and GANG keys. For safety, these duplicated keys are normally disabled, and have to be switched on via the MENU/SETTINGS page. Once the keys have been enabled this will be stored when the Show is saved.

The Arrow Keys and RECALL

The [up arrow] and [down arrow] keys are used in conjunction with the information displayed in the Cue List. Pressing either of these keys will scroll up or down the list, without implementing the settings of any of the Cues which are being scrolled through.

When the required Cue is reached, the user presses [RECALL]: this causes any settings pointed to by the selected Cue to be loaded into the desk, i.e. the desk is configured according to the settings held against this Cue. This Cue becomes the current one in the list and the cue name is displayed in green text to indicate this.

SETUP

Pressing [SETUP] opens the following page. This page can also be opened by touching the Cue List in the top right corner of the Master screen.

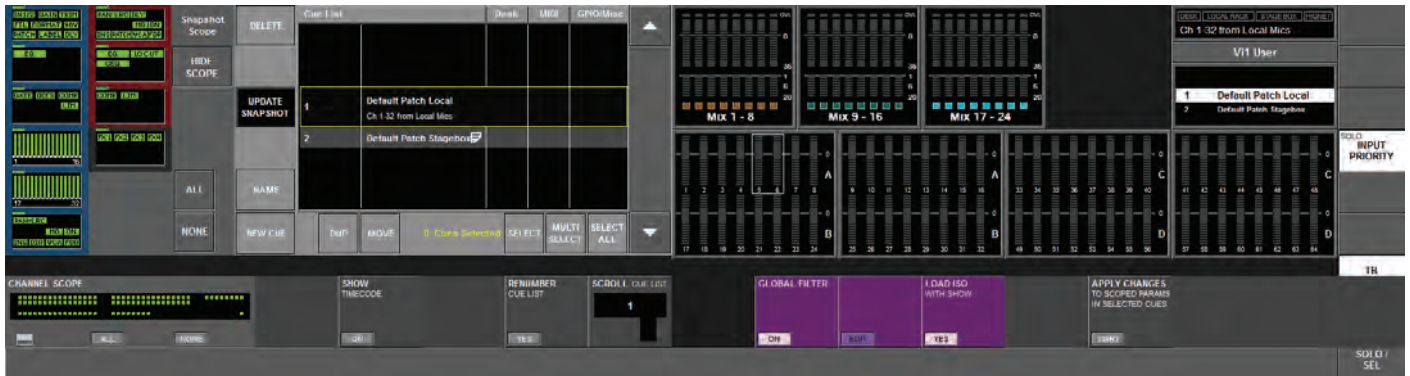

HIDE SCOPE/SHOW SCOPE Buttons

If the left-hand side of the screen above is not shown on your console it is because the Snapshot Scope is hidden in order to simplify the screen for new users. If you wish to see these controls, press the <SHOW SCOPE> button. The setting of the show/hide scope is stored in the Show.

The Cue List main page is divided into three main sections. The Cue List display itself; a set of touch buttons associated with the Cue List and performing various editing and other operations on the Cue List; and the Snapshot Scope Graphical User Interface -GUI, providing a way of quickly enabling various parameter groups to be recalled by desk snapshots, for each Cue.

Cue List Display

A Cue is a combination of a desk snapshot, various types of events and some text notes. The list allows the snapshots to be combined with transmitted events and arranged into a running order.

The Cue List is stored in the current Show. The list comprises columns for Cue Number (or Timecode), Cue Name, Desk Snapshot status (DESK), MIDI event status (MIDI), and GPIO, and HiQnet event status (GPIO/misc).

The oversize entry with a yellow border, in the centre of the list, represents the currently selected Cue (this

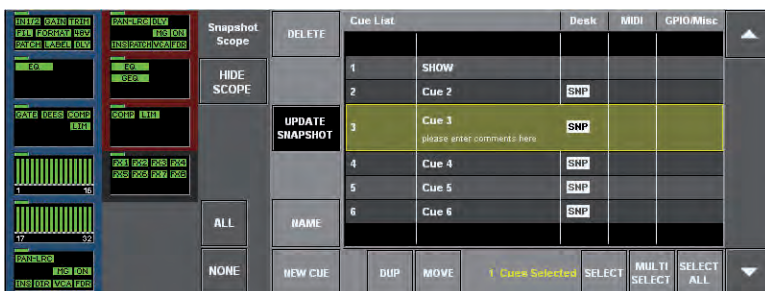

cue is not necessarily the currently recalled cue). Within the selected Cue is also an additional space that displays text notes that can be entered to give information about what the Cue does.

The columns of the list are able to display various icons that represent the various types of event that are possible to trigger, or be triggered by, the cues:



Snapshot icon: this is displayed in all Cues to represent the presence of the desk snapshot in the

Cue, but is greyed out if the desk snapshot is disabled locally within the Cue. It also appears greyed-out if the Desk column has been globally disabled.



MIDI IN & OUT Icons: these icons indicate the presence of a valid MIDI event in the cue. The blue icon represents a MIDI In event, where a MIDI message can be used to recall the cue. The red icon represents one or more MIDI out event(s). These icons will be greyed out if the MIDI column is globally disabled, or if the MIDI IN and/or MIDI out have been switched off in the MENU\MIDI page.



GPI/GPO/HiQnet event icons.

Displayed in the relevant column, these icons indicate whether an incoming or an outgoing event has been set for the Cue. If no event has been set the icon does not appear. Icons appear greyed-out if the column is disabled. In general, blue icons indicate incoming events, and red or yellow icons indicate outgoing events.

Global Enable/Disable control using Cue List Column heading buttons

These column headings can be touched to disable an event column (all events of that type are disabled for the whole list) or the whole Cue List can be completely disabled by touching the Cue #/Cue Name column heading. Pressing the column headings has a toggle disable/enable action.

As with all other parameters on the Cue List page, the states of these buttons is stored with the current Show.

<Cue List> column heading button: Enables/disables the recall of entire Cue List. If set to Off, the Cue List is locked and Cues cannot be recalled. The scrolling of the list, and editing of events is still allowed: only the [NEXT], [LAST] and [RECALL] keys on the surface are disabled.

<Desk> column heading button: Enables/disables the recall of desk snapshots for all Cues. When set to off, no desk snapshots will be recalled, even if desk snapshots are switched On within individual Cues. If a new Cue is created (e.g. by pressing STORE) whilst the Desk column is disabled, a cue will be created which does not include any desk snapshots.

<MIDI> column heading button: Enables/disables both incoming and outgoing MIDI events for all Cues. When set to off, no MIDI messages will be sent or received, even if the MIDI events are switched On within individual Cues.

<GPIO/Misc> column heading button: Enables/disables both incoming GPI and outgoing GPO events for all Cues. When set to off, no GPIO messages will be sent or received, even if the GPI or GPO events are switched On within individual Cues. For HiQnet, no HiQnet messages will be sent, even if the HiQnet events are switched On within individual Cues.

Edit & Control Buttons

These touch buttons allow a) creation of Cues, scrolling of the list, and b) various editing operations on the list such as Delete, Move, Duplicate, rename etc. To allow these operations to be carried out on more than one Cue at a time, a set of Multi Select buttons c) are also provided.

a) Action buttons

<SCROLL UP/DOWN> buttons: Moves the Cue List up and down through the central selection cursor. These buttons are duplicated by the action of the UP/DWN arrow buttons on the surface. The Cue List cursor will always indicate the Cue that will be recalled if the Recall button on the surface is pressed. The main Cue List page also contains a green highlight indication which shows which was the last recalled Cue.

<NEW CUE> button: If Cursor is at the end of the Cue List, pressing New Cue creates a new Cue with default name Cue xxx, where xxx = number of existing entries in the list +1. If the cursor is in another position in the list, a new Cue is inserted in the next position in the list (see Cue Numbering). In both cases, a desk snapshot is also generated and associated automatically with this cue, and the Desk Snapshot enable/disable state is set to ON (enabled).

The events status of all other event types is set to disable (OFF) and no events are assigned.

The settings of the Snapshot Scope are also stored with the currently displayed settings, along side the audio and surface parameters.

<UPDATE SNAPSHOT> button: Updates only the Desk Snapshot associated with the Cue, by overwriting the snapshot with the current state of the surface. A dialogue box appears to confirm this action. Note that Snapshot Scope settings do not need the Update button to be pressed in order to save them - changes to Scope are stored immediately.

b) Edit function buttons

<NAME> button: opens the QWERTY keyboard to allow the name of the currently selected Cue to be edited. The Cue is given a default name on creation in the format 'Cue X'. (The number is automatically incremented with each subsequent creation operation).

<DELETE> button: deletes the currently selected Cue(s). A dialogue box appears to confirm this action.

<DUP> button: creates a copy (or copies) of the currently selected Cue(s). The copies contain all aspects of the Cue, ie: Desk Snapshot and Events.

The names of the copies have a (D) added to the beginning of the Cue Name, in order to distinguish them from the originals, and are placed after the original.

If multiple non-adjacent Cues are selected and the DUP operation performed, the duplicates appear after their own original.

<MOVE> button: (Latching) Simulates a 'click & drag move function. When latched ON, a pre-selected Cue or adjacent group of Cues can be moved within the list by using the scroll buttons or encoder.

Note that only a continuous range of Cues can be moved – the Move operation will be inhibited if a selection of non-adjacent Cues is active when Move is pressed.

The <MOVE> button is renamed <DROP> after it is switched on, and pressing <DROP> will 'drop' the Cue or group of Cues at the point immediately after the last visible Cue above the selection bar. The Cue Numbers of these moved Cues will be recalculated according to the 'Inserted Cue' numbering rules (see Cue Numbering).

c) Selection mode buttons

<SELECT> button.

The SELECT button allows single or any number of adjacent or non-adjacent Cues to be selected for Delete, Duplicate or Move operations. It is equivalent to CTL+Click on a PC running Windows.

Touching SELECT will change the background colour of the central Current Cue selection bar from black to pale yellow. The Cue can be deselected by pressing Select again.

If the list is scrolled to another Cue after one has been selected, the yellow background will be retained on that previously selected Cue. A new Cue can now be chosen in the central bar and Select pressed again to add this one.

To deselect selected Cues, each one must either be brought into the Current Cue selection bar one at a time and the SELECT button pressed to deselect, or a 'select all' followed by 'select none' operation can be carried out –see Select All below.

<MULTI SELECT> button: dabbing the <MULTI SELECT> button selects the currently highlighted Cue with a latching mode, as with Select described above, but in this case the scroll control or arrow keys can be used to scroll through the list, and a continuous range of cues will then be selected.

When the required number of Cues has been selected, the Multiselect button is switched OFF, and the selection range stays in operation – the range can be seen by all visible selected Cues having a pale yellow colour.

Another range of Cues, not necessarily adjacent to the first, can be selected by repeating the above procedure in a different part of the Cue list. The 'Selected items' field (see later) keeps track of the number of selected Cues and is useful when some of the selections are outside the visible window.

Deselecting a range of Cues in Multiselect mode

If any of the Cues in an existing selected range is positioned in the Current Cue selection bar, then Multiselect is switched ON, the whole existing range selection is cancelled, ready to select a new range.

In order to go back and deselect individual Cues, the <SELECT> button must be used, as described above.

<SELECT ALL> button: Selects ALL the Cues in the List. When all Cues are selected, the button changes to a <SELECT NONE> button, which when pressed, deselects all Cues.

Pressing this button twice can therefore be used as a shortcut to clearing any existing selections in the Cue List.

Cues Selected field: A number is displayed next to the Select button, indicating how many of the Cues are currently selected.

CUE NUMBERING

CUE NUMBERING

New Cues that are created at the end of the list (depends on cursor position when Store or New Cue is pressed) are always given whole numbers.

Inserting cues (by moving an existing one or creating a new Cue with the cursor in the list) always generates a new number with one or two decimal places, at approx the mid-point of the existing numbers:

```
1.0
  Insert -> 1.5
2.0
1.0
  Insert -> 1.25
1.5
```

MOVING CUES

Moving Cues causes the moved Cues to be automatically renumbered.

The following example shows what happens to the numbering when Cues 2 & 3 are moved one step up the Cue List.

Select the range, press <MOVE>, scroll to required position, press <DROP> (cues will be renumbered),

1 cue 1	Move Cue 2 & 3 one step up:	1 cue 1
2 cue 2		4 cue 4
3 cue 3		4.3 cue 2
4 cue 4		4.6 cue 3
5 cue 5		5 cue 5

If some of the numbers end up being duplicated after this operation, this can be solved by selecting a wider range than the original block and pressing the Renumber Cue List button.

DUPLICATED CUES

A duplicated cue counts as a new cue as far as numbering is concerned.

RENUMBERING CUES

If cues have been moved around or have been inserted in the Cue List, the Cue Numbers will be a mixture of whole and decimal numbers. The RENUMBER CUE LIST {YES} key will renumber the cues. Pressing the button initiates a renumbering of the Cue List (Cue # column), the cues are renumbered as consecutive integers.

NOTE: There is a confirmation box which displays, 'Are you sure you want to renumber the Cue List?' and displays <YES> and <NO> touch buttons. The operation cannot be undone.

MANUALLY RENUMBERING

The Cue number can always be manually edited at any time by pressing the NAME button to open the QWERTY keyboard for renaming the Cue. The top left field in the keyboard allows the Cue number to be selected and a new number typed in. The Cue will be moved to the appropriate place in the list, according to the number given.

Snapshot Scope GUI

Please refer to the screenshot below. Note the <HIDE SCOPE> button, if the screen on the Vi isn't showing the scope information, press the <SHOW SCOPE> button.



The Snapshot Scope GUI allows the Snapshot Scope filter to be edited globally – by function block or parameter group, and by channel. Shortcut buttons in the GUI allow <ALL> or <NONE> of the parameter groups to be quickly selected or deselected in the Scope.

The elements displayed are divided into three categories: Input Channel (blue block border), Output Channel (red block border) and FX (grey block border). Within these categories, the parameters are grouped by function blocks.

Each Cue has its own Snapshot Scope, and the state of the Snapshot Scope for each Cue can be seen by viewing the Snapshot Scope GUI whilst scrolling through

or recalling the Cues.

Note that the Cues do not have to be recalled to do this.

The Scope of each Cue can be easily edited by simply touching the Scope fields, to select a whole block, or pressing & holding, to zoom a block onto the VST encoders below, where the encoder touch or VST buttons are used to select parameter groups within the block.

Illuminated Green mini-icons in the GUI show which parameter groups are enabled for recall in the corresponding snapshot. Note that these mini icons do not necessarily correspond exactly to the ones in the actual channel strips, but instead represent Parameter Groups, e.g. in the Dynamics block there is a Gate parameters group which represents the individual channel parameters of threshold, attack, hold, release and range: these individual parameters cannot be enabled for recall individually, they have to be selected as a group of parameters.

In the disabled state, the mini-icons are displayed in a low-intensity colour corresponding to their function (eg: blue for inputs, green for dynamics, etc), but this changes to bright green in all cases when the parameter group is enabled.

At the top left of each function block there is a green indicator LED. It indicates if all, some or none of the parameters in the block are selected.

Storing changes to Scope Settings

Storing changes to the Snapshot Scope is NOT done in the same way as for other desk parameters: ie: it is not necessary to press the <UPDATE SNAPSHOT> button to save the changes made to Scope into the currently selected Cue. Instead, the changes made to the Scope are immediately saved to the Cue as they are made.

When a new Cue is created, by touching the <NEW CUE> button, the Snapshot scope settings used for the new Cue will be the same as are currently displayed in the Scope GUI. They can then be edited after the Cue is created.

Changes to Scope across multiple Cues

If more than one Cue is selected, using the Multiselect function, then the Scope parameters behave as if they were in a gang – changing a Scope parameter in one Cue will cause the same parameter to change in the other selected Cue(s).

As with normal ganging on the console, Scope parameters that were already set to the desired state of the parameter being changed will not change unless the parameter is changed back to its original state again, in which case they will follow.

Selecting a complete function block:

A short press on the function block will select all the parameter groups within the block – all the mini icons will change to bright green. As many function blocks as required can be selected at the same time.

Zooming into a function block:

Press & hold the function block to open the zoom page on the VST encoders below, and allow individual elements within the block to be toggled. A white border to the block indicates its zoomed selection state. To exit, press & hold again.

When enabled, both the VST field and the mini-icon in the function block change to bright green.

Channel-wise selection of Scoped parameters

Immediately below the Scope GUI, there is a section of the VST encoder row that allows a channel selection (input and output) to be defined for the parameter groups. This is called CHANNEL SCOPE.

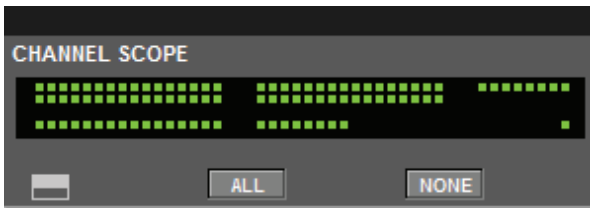

The channel selection section works in conjunction with the parameter group selection in the scope GUI so that a parameter will only be enabled in the snapshot recall on a given channel if both the parameter and the channel are enabled.

The channel selection is therefore stored with each Cue, as with the parameter group status. When a new Cue is created, the default state of the channel selection is ALL ON.

This channel selection GUI is designed to allow an overview display of which channels are selected, using a 'dot-matrix' type display. As the Cue list is scrolled, it is possible to watch the dot-matrix display and see which channels are selected on which cues, in the same way as the parameter groups can be watched in the upper part of the Scope GUI.

The  button is used to open a sub-page (see below) that allows channel selection to be made on the touch screen for each of the Input Fader pages A, B, C and D and the BUSSES 1-16 and BUSSES 17-24 page. These are selected by Bay number. Bay Numbers corresponding to Input Fader Bays give access to all input channels plus all busses, via the A, B, C, D and VCA MASTERS row of latching enable buttons.

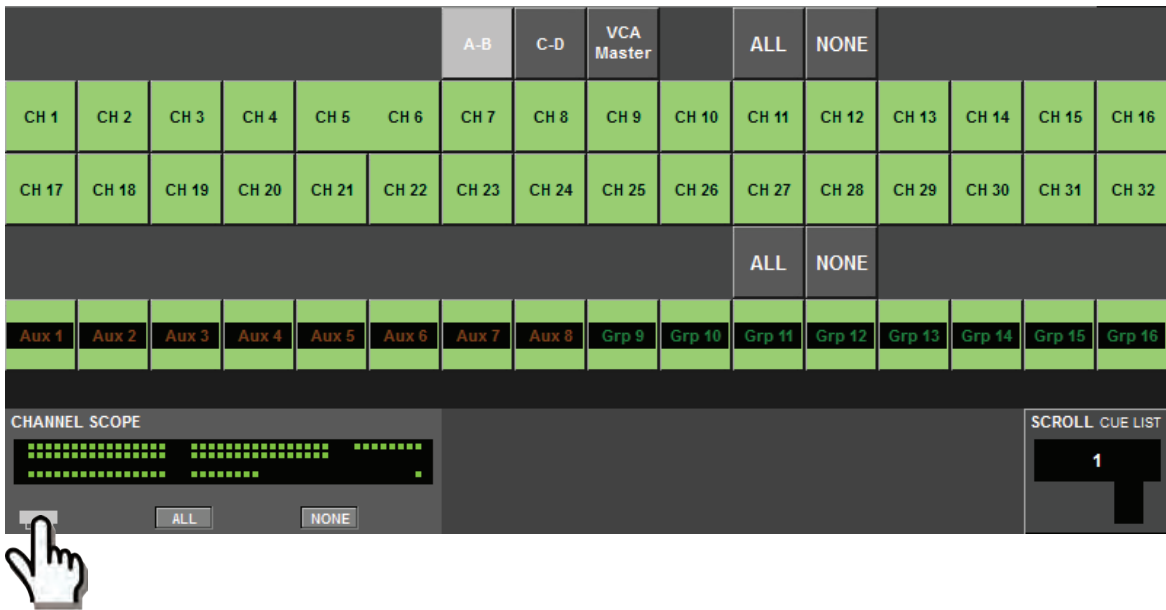

The <ALL> and <NONE> buttons in the VST section allow quick setting and clearing of all channels, busses and VCA masters, without opening the sub-page.

The **SOLO/SEL** buttons of channels and busses act as an additional way of selecting channels whenever the Channel Scope sub-page is open (Solo operation is always suspended when the sub-page is open).

SCROLL CUE LIST

The SCROLL CUE LIST encoder is always shown at the bottom right of the Cue List, and provides a faster alternative to scrolling the list using the scroll bars on the right-hand side of the touchscreen.

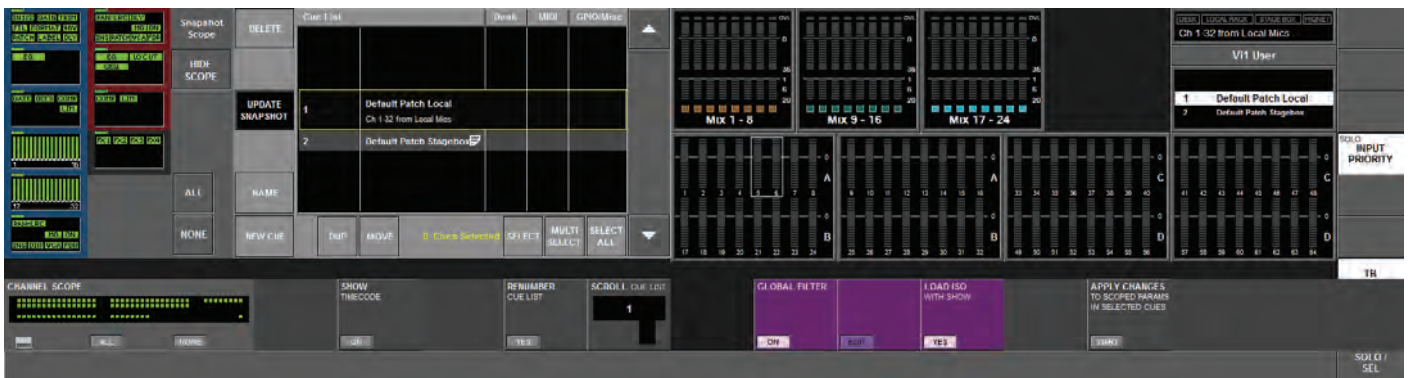

SHOW TIMECODES

When activated, the SHOW TIMECODE <ON> key replaces the cue number in the left-hand column of the cue list, with the trigger timecode value, if one has been set.

SORT BY TIMECODE

If a number of cues have a trigger timecode value set, pressing the {SORT BY TIMECODE} key allows the cues to be automatically re-arranged into timecode order. Cues that have no timecode trigger values are placed together in numerical order at the end of the list.

APPLY CHANGES TO SCOPED PARAMS IN SELECTED CUES

The software includes the capability to copy control settings that exist on the surface, into one or any number of other Cues in the Cue list. It is possible to define which controls from the current surface state will be stored, and which Cues you want to update with these control settings.

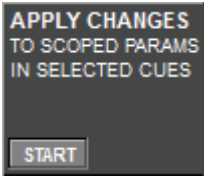

The changes made to the Cues will be 'absolute', ie the original setting of that parameter will be replaced by the new setting.

Start the process by ensuring the parameters you want to Apply are active on the surface. They do not have to be stored already in an existing Cue.

Press the START button in the Apply Changes field that is located on the bottom row of Vistonics controls below the Cue List.

This brings up the Scope selection panel on the left of the Cue list - this is now used to choose which parameters on the surface you want to copy to other Cues. You will notice the Scope panel appears with all parameters deselected, but all channels selected, this should speed up the selection process. In the example, the EQ on channel 24 only has been selected.

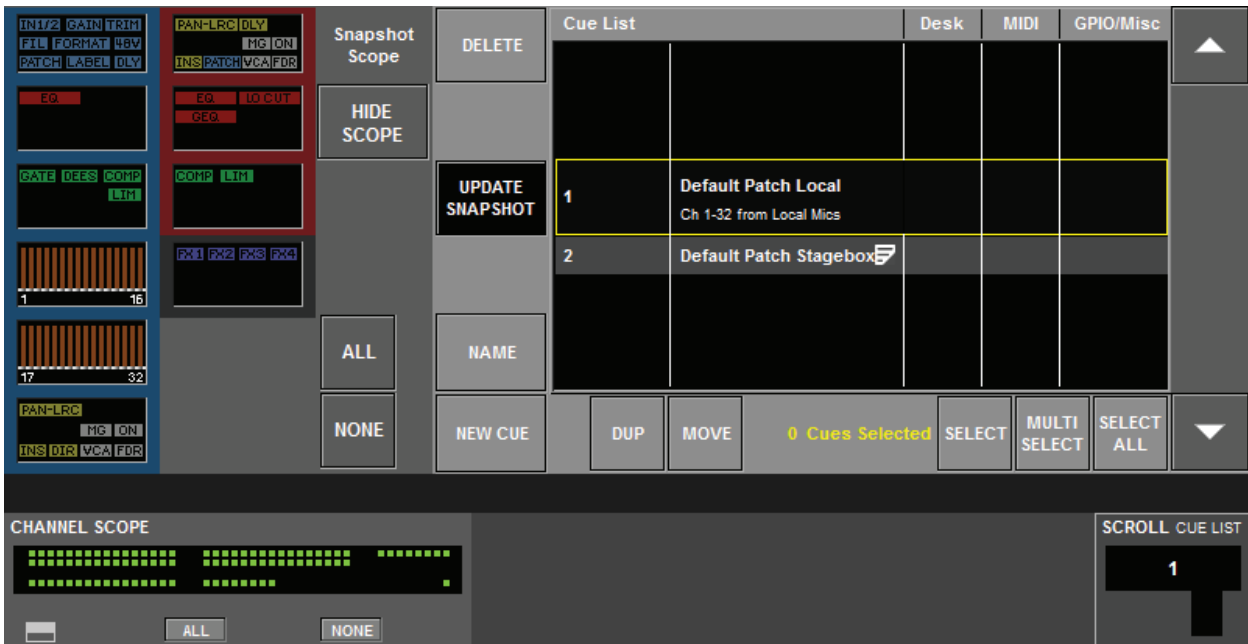

After the Start button has been pressed you will also see an additional field appear to the right of the Start button, giving the basic instructions for Apply Changes, and showing an APPLY button.

Once you have selected the parameters in the Scope selection panel, select which Cues you want to update by using the Select, Multiselect or Select All buttons below the Cue List. Then when you are satisfied with your selection, press the APPLY button. You still have another chance to make changes or cancel the process at this point, because a dialogue box appears asking you to confirm that you want to update the snapshots in the selected Cues.

Touch YES to finish the operation or NO to go back to the selection stage. When you press YES, the desk goes through an automated process where the Cues are recalled and automatically updated. You will see a progress dialogue as this is happening. Note that you will see controls moving on the surface as this is happening, but **no audio will be changed** during the process.

CUE LIST PAGE - Cue Number Field Touched

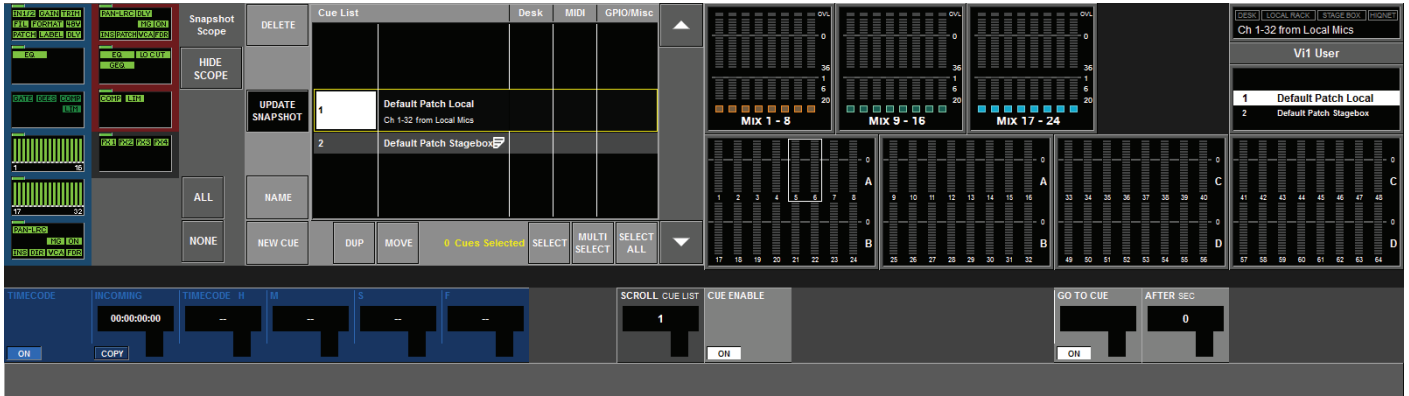

Touching the Cue Number area of the highlighted Cue switches the Vistonics encoders below to a new mode that allows specific parameters relating to this Cue to be edited.

CUE ENABLE {ON} key: Enables/disables the recall of this Cue in the List. When set to OFF, the Cue is jumped over in the list, if the [NEXT] and [LAST] keys are used to sequentially recall Cues. The Cue can still be selected by the scroll or up/dwn arrow keys on the surface (to allow editing of properties) but cannot be recalled by pressing the [RECALL] key (ie: no desk snapshot recalled, no events generated). When set to off, the whole Cue appears greyed out in the Cue List.

SEQUENCER

The sequencer functionality allows auto-triggering of another Cue at a preset time delay after this Cue has been recalled. In this way several Cues can be 'chained' together.

GO TO CUE {ON} key: Enables/disables the sequencer function.

GO TO CUE encoder: Selects the Cue number of the Cue that will be triggered after the set time interval. (The numbers in the field match the current Cue List numbers).

AFTER SEC: encoder: Sets the time delay after which the Cue specified in the GO TO field is recalled. Range 0- 30s, in 0.5s steps.

TIMECODE encoders: Allows a MIDI timecode value to be set (Hrs:Mins:Secs:Frames). The Cue will be recalled automatically when the set timecode value is received at the MIDI In, if the **ON** button is enabled. There is also a global Timecode ON switch in the Menu \MIDI page which must be enabled in order for timecode triggering to occur. Timecode frame rate is detected automatically, and the value of the received timecode is displayed in the INCOMING field..

The {COPY} key transfers the value in the INCOMING field to the encoders.

The {STEAL} key becomes active if the whole Timecode value matches one that is already assigned to another Cue. Pressing {STEAL} will reassign this value to the current Cue. The default value of all fields will be '-' (= no value). The values will be shown greyed out if they match the values of another cue.

CUE LIST PAGE - Cue NAME Field Touched

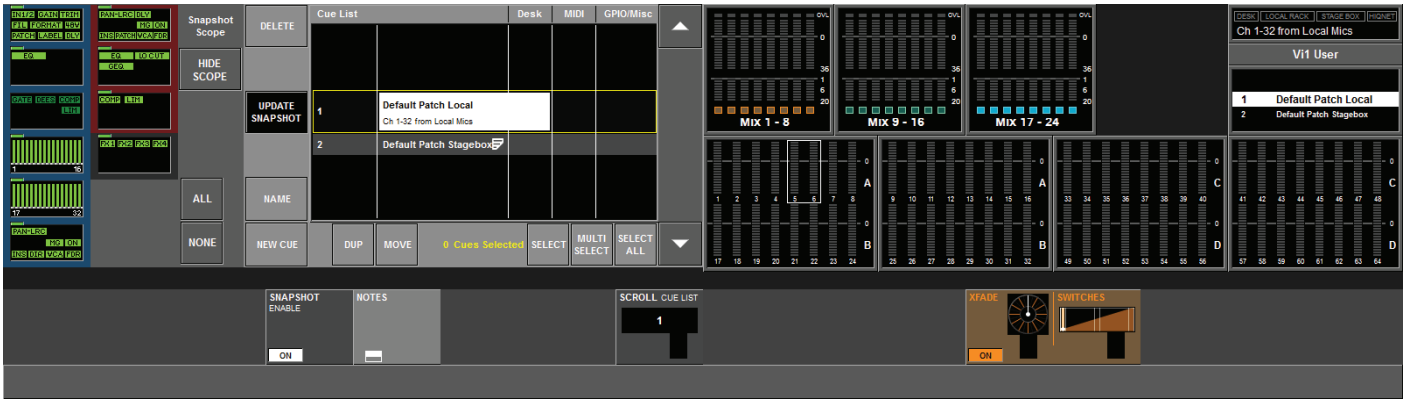

Touching the Cue Name area of the highlighted Cue switches the Visonics encoders below to a new mode that allows specific parameters relating to this Cue to be edited.

SNAPSHOT ENABLE - {ON} key: Enables/disables recall of the desk snapshot in this Cue. When not set to ON, the SNAP icon in the Cue List is greyed out.

NOTES sub-page key: Opens/closes the QWERTY keyboard and allows text notes to be typed that will be displayed in the highlighted Cue field in the Cue List page, and also (in shortened form) in the message area above the Cue List display in the Main Control Bay VST screen.

XFADE - Snapshot Crossfade

Snapshot Crossfade allows the recall of a desk snapshot to happen over a predefined time interval, rather than immediately. The interval can be set anywhere from 0.1 to 30 seconds, in 0.1s increments, using the Crossfade time control. This parameter applies to all parameters on all channels globally on the desk (it is not possible to set different Crossfade time on different channels).

Most 'variable' audio parameters of the desk that are included in snapshots will be included in the Crossfade, the exceptions are listed below.

- EQ and Hi/lo cut frequencies
- All Lexicon FX parameters

All switched parameters, plus the exceptions listed above will have their values changed at one of three points in the Crossfade: at the start, in the middle, or at the end. This is set globally for all the parameters via the 'Switches' control.

To set the Crossfade time for a specific Cue, press the Setup button in the Snapshot Control area of the control surface to open the Cue List page, then select the required Cue using the scroll bars or up/dwn arrow keys, and touch the name area of the currently selected Cue in the centre of the Cue List.

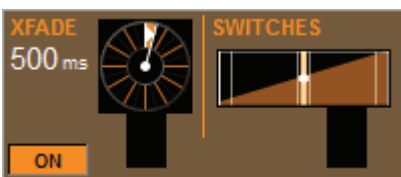

The time selected on the XFADE control below the Cue List will be the time taken for the desk to change from its current state, to the state of the snapshot in the selected Cue. In other words, the XFADE time can be thought of as an 'In' time for the Cue.

Each Cue can have its own 'In' time set using the XFADE control.

The Crossfade time can be disabled without affecting the time by using the On/Off switch. An icon is shown in the Cue List next to the desk snapshot icon if a Crossfade time has been enabled for that Cue.

Using Crossfade and Cue Chaining to create 'pseudo-dynamic Cues'

Using the Cue Chain facility in conjunction with the Crossfade function allows an approximation to 'dynamic' cue fader automation to be achieved. Using the Snapshot Scope facility to control what is recalled on each Cue can also be used to achieve different Crossfade times on different channels, if that is required.

To do this, try to break up the overall fader move required into several sections, and make Cues corresponding to the start and end points each section. Then chain the Cues together using the 'Go To Cue' parameter in the Cue List. (To find these parameters, open the Cue List page and touch the left-hand side of the currently selected Cue bar in the list)

SWITCHES

Fade time is global for all channels, and this control determines whether switched parameters change at beginning, middle or end of the fade.

Snapshot Preview Mode

Snapshot Preview mode allows snapshots to be recalled to the console surface without affecting the audio running in the DSP core, and so provides as useful way to check what is about to be recalled in a Cue, during a show.

When the desk is in Preview mode, the Control Surface is effectively taken off-line from the DSP core, so that existing Cues can be recalled or edited, or new ones created, and there will be no effect on the audio, which will continue running with the settings that were active at the moment Preview mode was switched on.

When Preview mode is switched OFF again, the surface will automatically jump back to match the state that it was in at the moment Preview mode was switched ON – meaning that it will once again be in sync with the audio.

When the desk is in Preview mode, no control of audio is possible, so the Preview button itself flashes, and a yellow/black striped strip is displayed across the bottom of all Input bay touch screens as a warning.

If you have made changes to the desk parameters whilst in Preview mode, and you want to keep these, you must either update an existing snapshot, or create a new one, otherwise the changes will be lost when you exit Preview mode.

You can also use Preview mode to 'lock' the audio before you change to a new Show file – the audio settings will remain as per the old show, and when you switch off the Preview mode the new Show settings will be applied to the audio.

CUE LIST PAGE - MIDI Field Touched

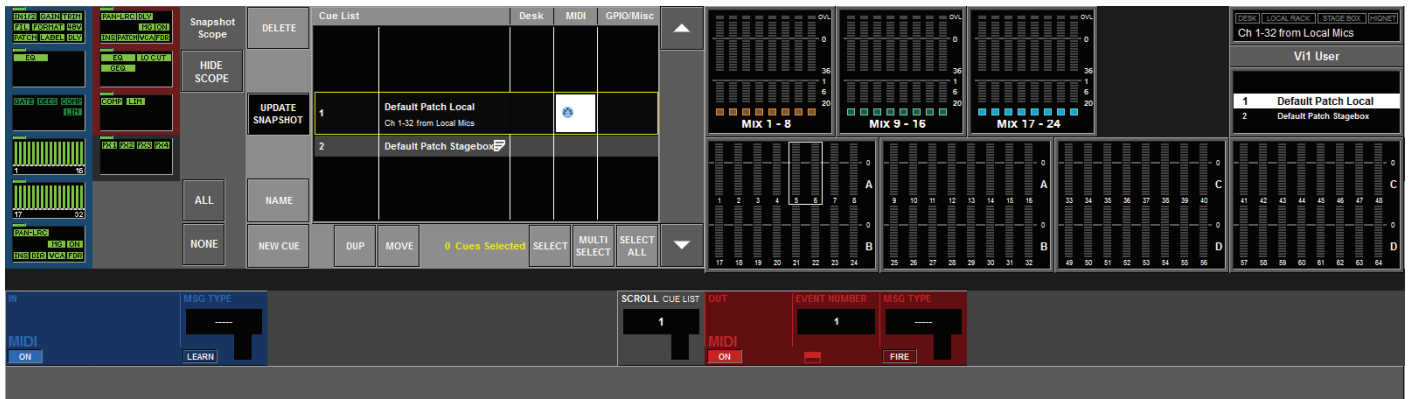

This page displays setup controls for a unique MIDI IN message that can trigger the current Cue to be recalled, and up to 20 MIDI OUT events that can be sent when the current Cue is recalled.

MIDI IN Setup

{ON} key: enables/disables the selected MIDI parameters from triggering recall of this Cue when they are received by at the MIDI input. When off, the currently selected Cue cannot be triggered by an incoming event. The ALL MIDI In {ON} key in the Main Menu\MIDI page must also be enabled for messages to be received.

MSG TYPE encoder: Defines the type of MIDI Message being received for this Cue. See page 22-5 for Message types, how displayed, and whether used for RX, TX or both.

VALUE 1 encoder: Sets the Value 1 for the selected message type (field name may change dynamically to reflect actual parameter type according to selected message type).

VALUE 2 encoder: Sets the Value 2 for the selected message type (field name as above).

Value 2 is not applicable to all types of messages, but in this case an empty field will be displayed.

CHANNEL encoder: Allows the MIDI 'listening' channel for this Cue recall to be set. Value range is 'No Device', then 1-16, then 'Global' but the displayed value for 1-16 is taken from the Device Name field of the MIDI RX Device List (see Page 22-1, Main Menu\MIDI page). The Device list allows MIDI Channels to be mapped to a text name for easier identification of the devices being selected.

{REC} key: When active, the MIDI input of the desk 'listens' to incoming messages on all channels, and when it receives the first one that matches a supported trigger event type, it automatically populates the Channel, Msg Type and Value 1 & 2 fields to match the received message. Any previous parameters are overwritten with no warning. The {REC} key switches off automatically when a valid message has been received, or the MIDI page is closed. (note: SysEx, MMC or MSC messages are not supported by the REC function).

{STEAL} key: Only appears if exactly the same combination of message type, channel, and values 1,2 (all these parameters must match) has been set up as a trigger on another Cue.

Pressing the {STEAL} key when it is visible immediately reassigns the displayed parameters to the current Cue.

Default settings stored in current Show are:

- On key = OFF
- Channel = 'No device'
- REC key = OFF
- Message Type= blank
- Value 1&2 = blank

MIDI OUT Setup

The MIDI Out setup differs from MIDI In, in that instead of only 1 event for the Cue, there is an 'Events List' per Cue of **up to 20** events that can be transmitted.

Each of the events can be transmitted on any of the 16 MIDI channels on the MIDI OUT port.

{ON} key: enables/disables the transmission of the currently-selected MIDI event when the currently selected Cue is recalled (separate value for each of the 20 events).

The ALL MIDI Out {ON} key in the Main Menu\MIDI page must also be enabled for messages to be transmitted.

EVENT NUMBER encoder: Scrolls through the 20 available MIDI OUT events on each Cue, and allows the Event parameters to be viewed or edited on the other VST encoders.

EVENT NUMBER sub-page key: Opens the Event List sub-page (see screenshot on page 15-19). Although the 20 Events can be set up parameter-wise using the VST encoders, and scrolling the Event Number, the Events List makes it easier to see a glance all 20 events, and view their parameters in a table format.

MSG TYPE encoder: Defines the type of MIDI Message being sent for the selected Event Number.

See Chapter 22 for Message types, how displayed, and whether used for RX, TX or both.

VALUE 1 encoder: Sets the Value 1 for the selected message type.

(Field name may change to reflect actual parameter type according to selected message type).

There are two special cases of the MSG Type parameter – MMC Locate and SysEx – which cannot be accommodated by the Value 1 & 2 fields.

These two cases also result in the Channel parameter being replaced by a DEVICE ID, selected from the global TX Device ID list in the Menu\MIDI page).

When the **MMC Locate** message type is selected, the Value 1 & 2 fields are replaced by 4 fields allowing the Timecode value to be set.

When the **SysEx** message type is selected, the Value 1 field changes to include a sub-page key which opens the QWERTY keyboard and allows the string to be entered in Hexadecimal format. When the string is longer than the number of characters displayable in the VST field, it is abbreviated with '...' –see below.



CHANNEL encoder: Allows the MIDI 'transmit' channel for the currently selected Event Number to be set. Value range is 'No Device', then OUT1:1-16 and OUT2:1-16, then 'Global', but the displayed value for OUT1:1-16 and OUT2:1-16 is taken from the Device Name field of the MIDI Devices LIST in the Main Menu\MIDI page.

The Devices list allows MIDI Channels to be mapped to a text name for easier identification of the devices being selected.

Note that where the Message Type being selected has a Device ID rather than a MIDI Channel (which will be the case only if the MSG Type is set to MMC Locate, SysEx or Go to Cue then the Device ID will be displayed instead of the channel.

{FIRE} key: When pressed this transmits the displayed MIDI event for test purposes during equipment setup. Only the currently-selected event from the list of 20 is transmitted.

SCROLL CUE LIST encoder: Allows the Cue list to be scrolled whilst the EDIT MIDI page is open, allowing the Events Setup to be compared between Cues.

Default settings stored in current Show are (for each of the 20 Events):

On key = OFF

Channel = 'No device'

Message Type= blank

Value 1&2 = blank

CUE LIST PAGE - MIDI Field Touched & Event List Open

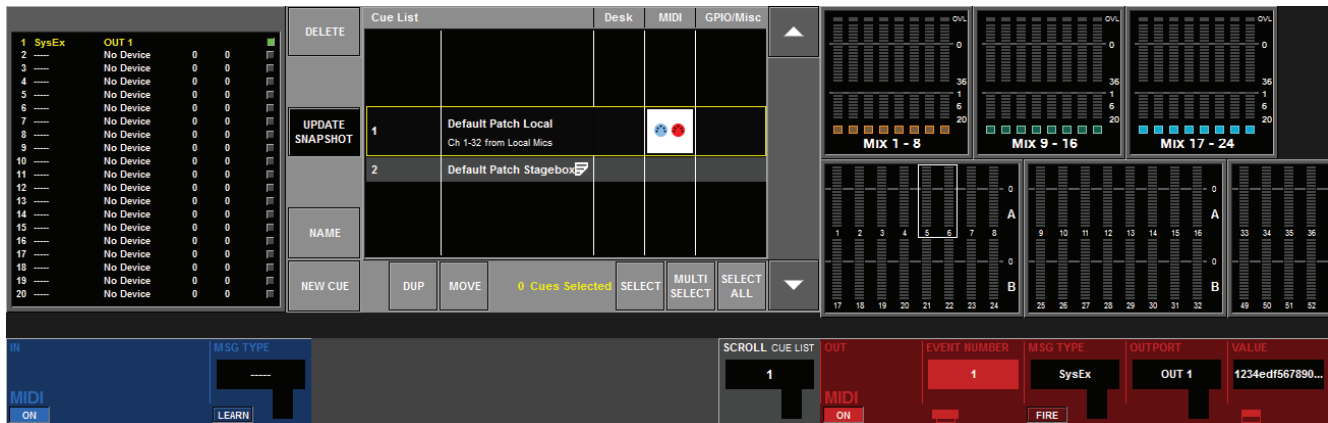

Pressing the sub-page key in the EVENT NUMBER VST field opens the Events sub-page, which is displayed to the left of the Cue List.

Note that the events will be transmitted in the order that they appear in the list (i.e. No.1 first), although the speed of transmission of all 20 events is almost simultaneous. However the order can be important: if, for example, you wish to locate a playback machine to a timecode value and then start it playing the Locate command must be placed before the Play command.

The page gives visibility of all of the MIDI out events that have been set up for the currently selected Cue (up to 20 events).

The {SCROLL CUE LIST} encoder can be used to scroll through the Cue List whilst the Events sub-page is open. In this way it is easy to compare the MIDI Event setups for different Cues.

If more than 20 Events are necessary, the Sequencer function (see page 15-13) can be used to 'chain' two or more Cues together from a single Recall command.

The sub-page is closed again by pressing the sub-page key (there is no Exit button).

CUE LIST PAGE - GPIO/Misc Field Touched

Note: GPIO functionality is only possible on the Vi1 if a stagebox is attached, or a GPIO card is fitted to the D21m option slot.

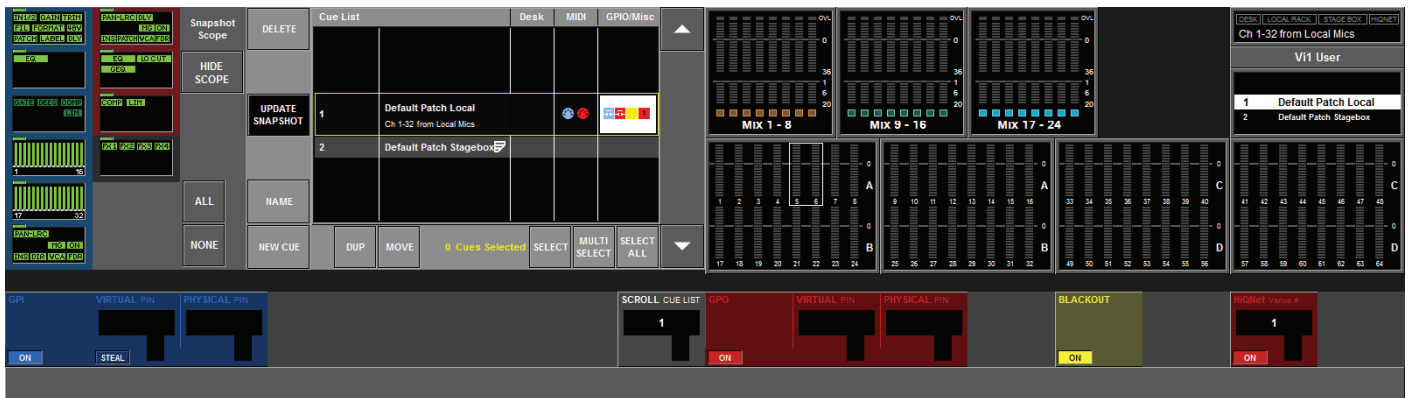

GPI {ON} key: Enables/disables reception of the defined GPI signal from recalling the current Cue.

VIRTUAL PIN encoder: Allows a Cue List Virtual GPI Pin to be selected as the trigger source. The Virtual Pin must be assigned to a real (Physical) Pin in the GPIO Page. The Virtual pin number display is in grey text if that pin is already used by another Cue.

{STEAL} key: Only displayed if the selected Virtual pin is already assigned to another Cue. Pressing the STEAL button reassigns the Virtual pin to the current Cue (no warning dialogue given).

PHYSICAL PIN field: displays the physical Pin number that is currently assigned to the selected Virtual Pin. (Display only). If a physical pin has not been assigned, this field will be empty.

GPO {ON} key, as above, but for outgoing GPO events. The Virtual GPO pins must be set up in the GPIO page.

There is no need for a Steal key on GPOs, several Cues can be assigned to the same v-pin. Note that although there is only one v-pin per Cue, a v-pin can be assigned to any number of physical pins in the GPIO setup page.

HiQnet {ON} key: enables/disables the transmission of the assigned HiQnet Venue Change message upon recall of this Cue.

HiQnet encoder: Allows selection of the Venue Change number that will be transmitted from the HiQnet Ethernet port when this Cue is recalled.

Note that the IP address of the console must be set up in order to use the HiQnet functionality. These parameters are available in the Menu\system\HiQnet page (see chapter 14).

Global Filter

ISO Key Functionality

[ISO] keys on the consoles input and output channel strips have 3 states: 2 ON states and 1 OFF state. Pressing the key will cycle round the states in the order OFF, ON1, ON2, OFF, ON1 etc.

Note that state ON2 will only exist if a partial Isolation has been set up on the strip (using the press & hold functionality – see below).

OFF state: (key not illuminated): No Isolation of any parameters.

ON1 state: (key illuminated): Full channel Isolation – purple border around channel/bus

ON2 state: (key illuminated): Partial Isolation activated on strip, if this has been set up using one of two methods : Press & Hold or Edit Global Filter mode. Indicated by the selected individual parameters displayed in purple.

Press & Hold ISO Key Functionality

To make a partial isolation: hold down an [ISO] key and make a short press on the VST function block to select the whole block. A wide purple LED-style indicator on the screen shows the isolated block state.

If the function block is NOT already zoomed, it is possible to hold down the [ISO] key and then press & hold the function block for 2 secs, in order to activate the zoom mode.

If the function block is already zoomed, individual parameters can be touched, (or the adjacent VST key pressed) and the parameter label text will change to purple to indicate selection.

The colour of that parameter in the function block touch field will change to purple to indicate parameter-level isolation.

Global Filter ON/OFF switch

A set of master controls for the Global Filter is located in the VST area in the Cue List screen.

The Global Filter master {ON} key allows the complete Global Filter settings on all channels to be temporarily switched off if required.

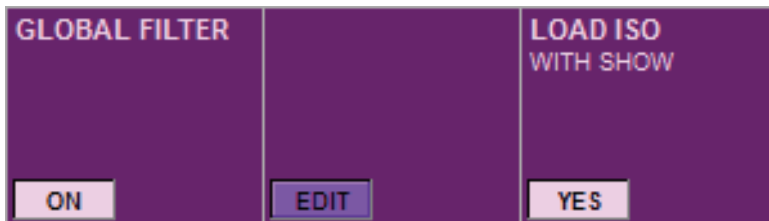

The Global Filter Master {ON} key switches ON as soon as any ISO buttons on the console are pressed. If Global Filter On is then switched OFF, the isolation state and all indications of it on the surface will be removed (including illuminated [ISO] keys and purple Vistronics graphics). The state of these will be held in memory however, enabling it to be switched back on again later.

If Global Filter On is switched ON again, without pressing any [ISO] keys in the meantime, then the state of the filter will be restored from memory to the surface.

Clearing The Global Filter

If the Global Filter {On} key is OFF, pressing any local [ISO] key (either short or long press) will clear any previously set Global Filter, which may be being held in memory, and start a 'new' Global Filter on the surface with the newly-selected parameters.

The Global Filter On switch in the Cue List page will automatically change to the ON state when the first parameter is selected.

Global Filter settings are indicated on the Vistonics screens by means of the colour purple, as follows:

- A complete purple border around an input channel or output bus = full channel/bus isolated
- A wide purple LED indicator in the top left of a function block = complete function block isolated
- A narrow purple LED indicator in the top left of a function block & individual purple parameter icons in the function block = some parameters isolated
- Purple parameter name(s) within a zoomed function block = parameter isolated
- A horizontal purple bar across the screens (except the control bay) indicates that the whole console is in Edit Global Filter mode (see later).

*Note: if there is no FX assigned to an output bus the purple border will not encompass the FX function block.

Remember that the Global Filter of the console can also be edited directly on the console surface, without losing control of the majority of the surface, by using the [ISO] keys, as described on the previous page.

In conjunction with the Gang function, the [ISO] keys enables horizontal groups of channels, function blocks or individual parameters to be quickly set in and out of isolate (Global Filter) mode.

Edit Global Filter Mode

The {EDIT} GLOBAL FILTER key (see Fig 15-18) will switch the whole console into an edit mode which is the equivalent of 'Press & Hold on all ISO keys at the same time'. (ISO keys continue to work, but only with their 'Isolate All on this Channel' function, in this edit mode. There is no actual press & hold ISO functionality in this mode – it is not required).

In this mode the horizontal bars across all VST screens (except the control bay) will change from their normal colour (Blue or Red) to Purple, to indicate that audio can no longer be controlled from the VST screens.

Selecting function blocks or individual parameters is then done as follows: touch the function block with a short press to select the whole block (indicated by the wide purple indicator) or press & hold the function block to enter zoom mode, where individual parameters can be touch selected (or by VST key).

Note that the filter parameters being edited here are the same ones that are set by the "holding down [ISO] key" method previously described.

The reason for having two methods of editing the same parameters (locally using ISO or globally using Edit Global Filter mode) is that whilst the ISO method allows very fast, immediate control of channel filtering, even using Gang in addition to quickly set filters across the whole console, if there are a lot of parameters to be set into Isolate mode, the latching Edit Global Mode will be easier to use.

The [SEL] key is used to select whole channel to isolate mode. The [ISO] key can still also be used.

LOAD ISO WITH SHOW

The {YES}/{NO} key (its legend toggles) enables the user to recall (or not) the new Global Filter settings when a new Show is loaded.

The purpose of this feature is to allow ISO buttons to be used to protect sections of the console (e.g. output section and master outputs) from changing when a new show is loaded in. This can be useful in a multi-band situation where the desk outputs are set up for the PA system but a visiting engineer wants to load their own show without changing the output section (or the interval music CD player for example). Setting LOAD ISO WITH SHOW to NO, and then switching the required parts of the show to ISO, will allow the show to be loaded without changing the isolated parts. The state of the key is not saved but defaults to YES when the desk is powered up.

MANAGING SHOWS

Loading Shows, copying Shows to and from USB data storage devices, and creating new Shows is done from the following page. It is reached by pressing [MENU] and then the <SHOW> tab at the top of the page (or the Show name at the top of the Cue List display area, which is at the top right corner of the main screen, can be touched).

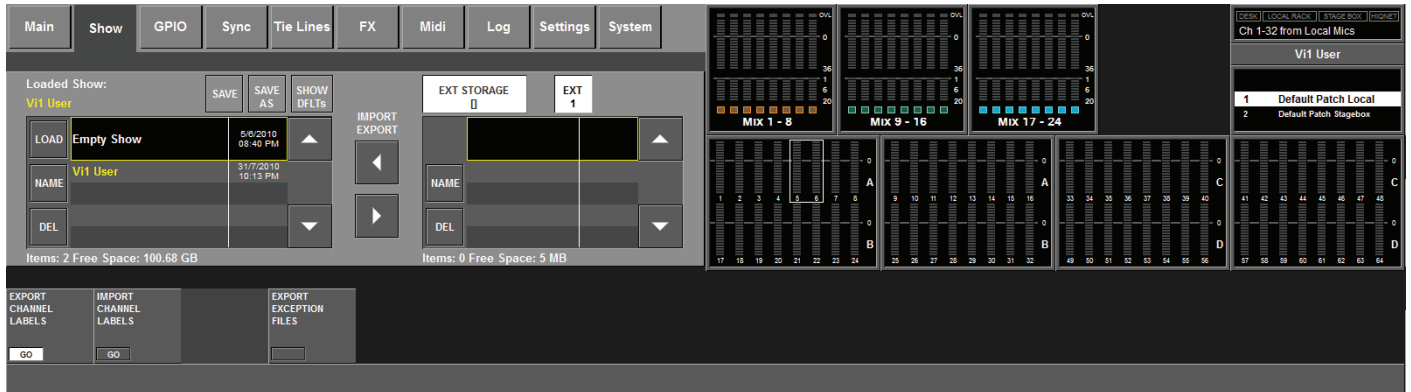

Note that the Show page appears as shown above if a USB data storage device is present in the USB slot. If there isn't any external memory, the right-hand side of the screen is blank, and the Export/Import Controls are not shown. Up to 3 external storage devices can be connected: if more than one is detected, additional buttons will appear to the right of the <EXT1> button, and pressing the required button will select that device.

Flash Drive

The left-hand side of the page displays the shows which are present on the console's flash drive. The up and down-arrows on the touch screen are used to scroll through the available Show titles. Pressing and holding the arrow keys scrolls at a higher speed. Once the required show has been highlighted, in the double-height yellow-outlined box, the three buttons on the left can be used as follows:

The <LOAD> button will load the selected Show into the console (note that the currently-loaded show's title is shown in yellow text above the list).

The <NAME> button allows the user to name/rename the show, the on-screen keyboard is displayed.

The button deletes the show from the flash drive (note that the currently-loaded show cannot be deleted). A confirmation dialogue is displayed.

Default Shows

The console comes with some factory-installed shows. These are not normally visible in the list, but they can be seen by pressing the <SHOW DFLTs> button. The default Shows are at the top of the list and are shown in italic text. They cannot be deleted with the button, nor renamed. The Default Shows are designed to reset the whole console back to a 'flat' starting point.

Creating A New Show

The user can select a default show or another existing show and use the <SAVE AS> button. The user will then be asked to enter a name for the new Show using the on-screen keyboard. This new show can then be edited as required.



IMPORTANT: If you want to base your Show on one of the defaults, you **MUST** save it as a new show before you start working, otherwise you will not be able to store Cues. This is because of the write-protection assigned to the default Shows. It is good practice to create your new show using the SAVE AS facility before you start to make your setup on the console.

Updating A Show

A loaded show can be updated at any time by pressing the <SAVE> button (but not if you have a Default show loaded). If you are not using Cues to store the state of the desk, it is essential that you save your Show in order to keep any changes made to the surface since you created the Show.

USB Data Storage Device

The right-hand side of the page displays the shows which are present on the installed USB data storage device. Normally the front panel USB Data Socket will be used (EXT1), but it is possible to connect USB data storage devices to the rear panel USB sockets (EXT2 and EXT3), and select the required device by using the <EXT1><EXT2><EXT3> buttons. The up and down-arrows on the touch screen are used to scroll through the available Show titles. Once the required show has been highlighted, in the double-height yellow-outlined box, the two buttons on the left can be used as follows:

The <REN> button allows the user to rename the show, the on-screen keyboard is displayed.
The button deletes the show from the USB data storage device.

Exporting A Show To A USB Data Storage Device.

Pressing the right-facing arrow will export the currently-selected Show to an installed USB data storage device. Note that the date and time of the latest save is shown in both lists.

Importing A Show From A USB Data Storage Device.

Pressing the left-facing arrow will import the currently-selected Show from an installed USB data storage device. Note that the date and time of the latest save is shown in both lists.

With Importing and Exporting, a dialogue box appears showing progress. To avoid data loss do not remove the storage device until the progress box has disappeared

Export/Import Channel Labels

These keys allow the user to export a list of current Channel names in CSV (comma-separated values) format. This file can be edited in a PC spreadsheet package and then imported back into the desk. The file name is *Soundcraft Vi channel labels.csv*. Pressing the appropriate GO key immediately exports or imports the file to a USB memory device. These keys are only available if a USB memory device is connected.

Note that there is no progress dialogue because the operation is almost instantaneous.

Export Exception Files

If the console's on-board computer malfunctions an exception file is automatically written to the flash drive. Pressing the GO key will write this file to a connected USB memory device. A service engineer may want to look at this file. This key is only available if a USB memory device is connected.

RECORDED DATA

As was mentioned previously, some settings are recorded as part of a Show, others as part of a Snapshot, and a few are not recorded at all. The following diagram shows how this is done.

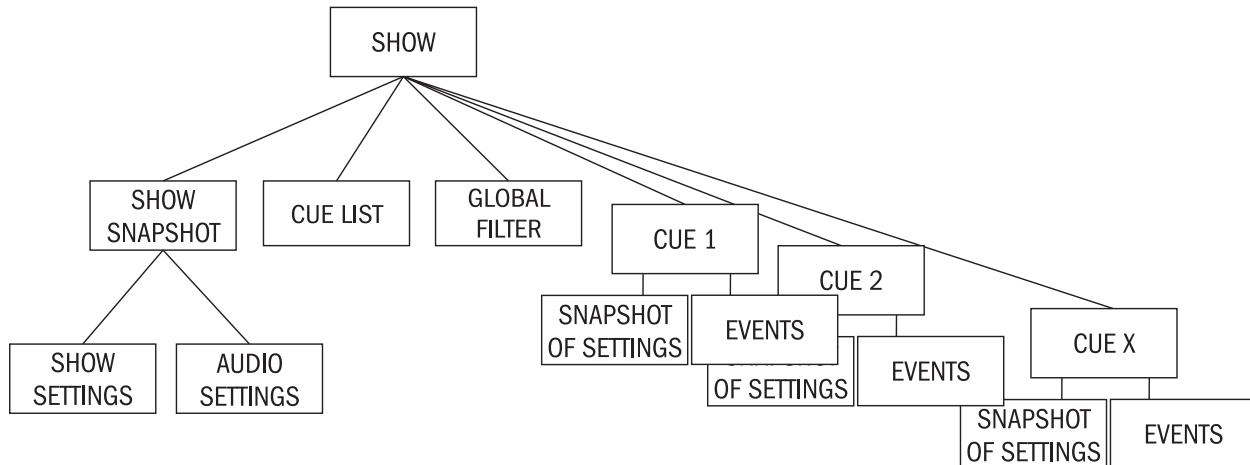

Note that a Show has one hidden Show Snapshot. This Show Snapshot is generated automatically, and it cannot be seen by the user. It holds the Cue List, the Show Settings and Audio Settings. These three sets of data contain all of the parameters which change when a Show is loaded.

The Show Snapshot's Audio Settings contains all the settings which a standard Snapshot can store; as a result, the Show Snapshot can be thought of as the last settings before the Show was unloaded. The Show Snapshot allows the complete status of the console to be recorded with the Show, even if no Cues have been saved.

Settings Recorded Within A Show Snapshot's Show Settings

Monitoring Settings: Monitor Level; Phones Volume; Solo Trims; Solo Blend; Monitor A/B Switch Status; Monitor On/Off Switch Status; Monitor Source Selection Status; Monitor Setup states.

All switches in Talkback section.

Talkback Settings: Talkback Levels; Talkback setup.

Generator Settings: OSC Level, Type.

Mute Safe Status (Input & Output).

System Preferences: Current Sample Rate; Sample Clock Settings.

Automation Setup States.

VCA / MG Assign View switches status: Currently selected view.

Bus Config States: Bus Formats; Bus Types and Bus Labels.

Channel Pairing States: Stereo Channel pairings (but only when Shows have been saved on the same console type:Vi1).

MIDI Configuration Setup: MIDI Channel names.

ISO switch status (Input & Output). This depends on the setting of the LOAD ISO WITH SHOW parameter in the Cue List page.

O/P Vistonics Lock Mtr switch status.

O/P Vistonics Solo/OnOff/TB switches.

All parameters in the menu/settings page.

Follow Solo switches.

Mute Group Master switch status.

Settings Recorded Within Audio Settings

This applies to the Show Snapshot and to any standard Cues.

All Channel* audio settings on the console: Channel ON; Fader positions; Pan; Channel Parameters (EQ/Dynamics/input/output/ insert).

All Channel Bus assigns, levels, Pre/Post states and Channel Labels.

All Channel Patch settings.

All I/O controls.

*A 'channel' is an input, output or Master LRC channel.

Settings Not Recorded

PFL/SOLO switch status.

LRC Sel switch status.

All round Setup switch status.

User Defined switches (O/P fdr pnl) status.

All switches in Snapshot Control section.

Copy/Paste/Undo switch status.

Set Pre/Post modes switch status.

Pan/Level toggle switch status.

Upper & Lower Encoder Row Assign switches status.

Gang Mode switch status.

Solo Clear switch status.

Settings Restored To Their State At the Last Power-Down

Which Show was loaded.

LOAD ISO WITH SHOW switch status.

Show Compatibility

Vi4 and Vi6 Consoles

Shows which are saved on a Vi1 can be loaded on a Vi2, Vi4 or Vi6. All settings will be recalled except for the channel pairing, which is not imported due to the differing vertical arrangement of channels in the fader pages.

Shows which are saved on a Vi2, Vi4 or Vi6 can be loaded on a Vi1. Channels above 64 will be ignored and will be deleted from the show when it is saved on the Vi1. Busses 25-32 will be ignored. The pairing information is ignored as above.

CONFIGURATION

In the GPIO (General Purpose Input Output) Page you can configure all GPIO channels that are available in the Soundcraft Vi1™ if the optional Vi6-type stagebox is fitted. To access the GPIO page, press the [MENU] key, this opens the Main menu page on the master section screen, then touch the <GPIO> tab (see also chapter 14).

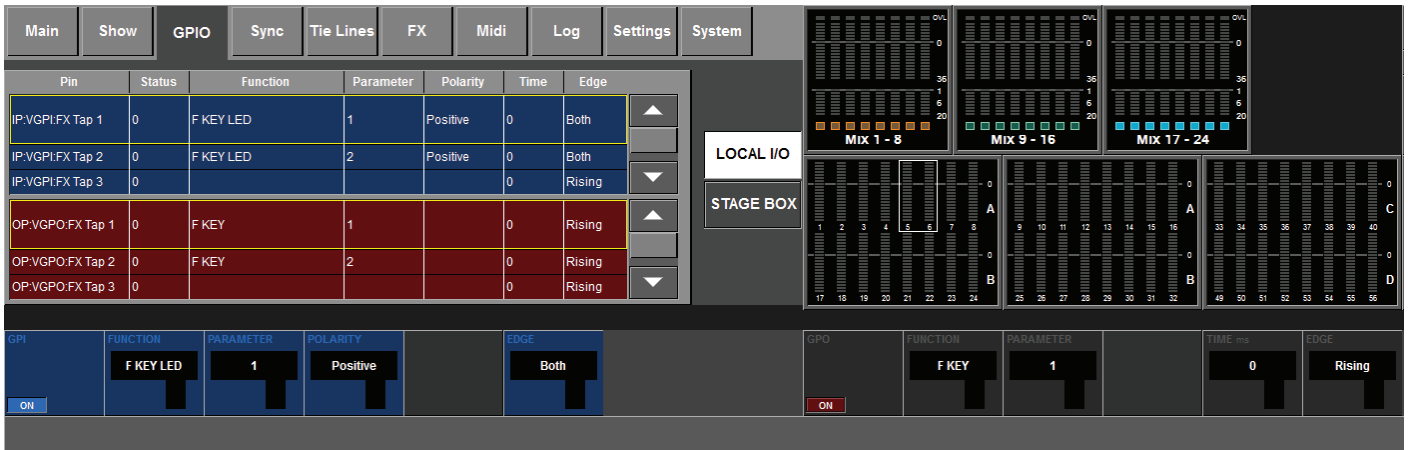

The scrollable tables show the configuration of the GPIO channels. The configuration is done via the VST fields. The selections made via the VST keys and encoders are reflected in the tables on the screen. For each GPIO channel, the polarity, time (outputs only) and edge can be configured, to make it easy to interface directly to different device types.

Screen Touch-Pads

<LOCAL I/O>

Selects the GPIO in the Console (FX Tap functions only).

<STAGE BOX>

Selects the GPIO in the Stage Box (8 GPIO).

Up and Down Arrows

The pair of Up and Down Arrows are used to scroll through the two lists. The currently-selected input and output channels are outlined in yellow. GP Inputs are displayed in blue, and GP Outputs are displayed in red.

GPIO VST Keys & Encoders

GPIO Field

The {ON} key enables the selected GPI function. GPIO Inputs are via opto-isolators.

Function Field

This field displays the Input function. Its encoder selects the function.

Parameter Field

This field displays the Parameter (e.g. Channel number). There is no parameter for TB INPUT. The encoder adjusts the Parameter.

Polarity Field

This field displays the Polarity of the input. The encoder changes the polarity between positive (+) and negative (-). This field is only available if the {EDGE} field is set to BOTH.

Edge Field

This field displays the triggered Edge. The encoder adjusts the triggered edge between rising/falling/both.

GPO VST Keys & Encoders**GPO Field**

The {ON} key enables the GPO function. GPIO Outputs are via pairs of relay contacts.

Function Field

This field displays the Output function. Its encoder selects the function.

Parameter Field

This field displays the Parameter (e.g. Channel number). There is no parameter for TB OUT. The encoder adjusts the Parameter.

Polarity Field

This field displays the Polarity of the Output. The encoder changes the polarity between positive (+) and negative (-). This field is only available if the {EDGE} field is set to BOTH.

Time Field

This field displays the relay pulse time. The relay contacts will revert to their original position at the end of the pulse time. The encoder adjusts the pulse length in ms (a blank field means no pulse is generated, i.e. the relay contacts stay in their new position).

It is suggested that a pulse time is set only when the EDGE field (see below) is set to 'RISING' or 'FALLING'. It is also suggested that no pulse time is set when the EDGE field is set to 'BOTH'. See Figure 16-2 for a timing diagram of relay operation using fader start.

Edge Field

This field displays the triggered Edge. The encoder adjust the triggered Edge between rising/falling/both.

	FUNCTION	PARAMETER	POLARITY	TIME	EDGE
INPUTS	CH MUTE	1-64 (channel)	POSITIVE NEGATIVE		BOTH RISING FALLING
	F KEY LED	1-6 (f key)	POSITIVE NEGATIVE		BOTH RISING FALLING
	TB INPUT		POSITIVE NEGATIVE		BOTH RISING FALLING
	DIM MON	A or B (monitor)	POSITIVE NEGATIVE		BOTH RISING FALLING
OUTPUTS	FDR START	1-64 (channel)	POSITIVE NEGATIVE	0-500mS 0-500mS 0-500mS 0-500mS	BOTH RISING FALLING
	F KEY	1-6 (f key)	POSITIVE NEGATIVE	0-500mS 0-500mS 0-500mS 0-500mS	BOTH RISING FALLING
	TB OUT		POSITIVE NEGATIVE	0-500mS 0-500mS 0-500mS 0-500mS	BOTH RISING FALLING

Figure 16-1: Summary Of Available Settings.

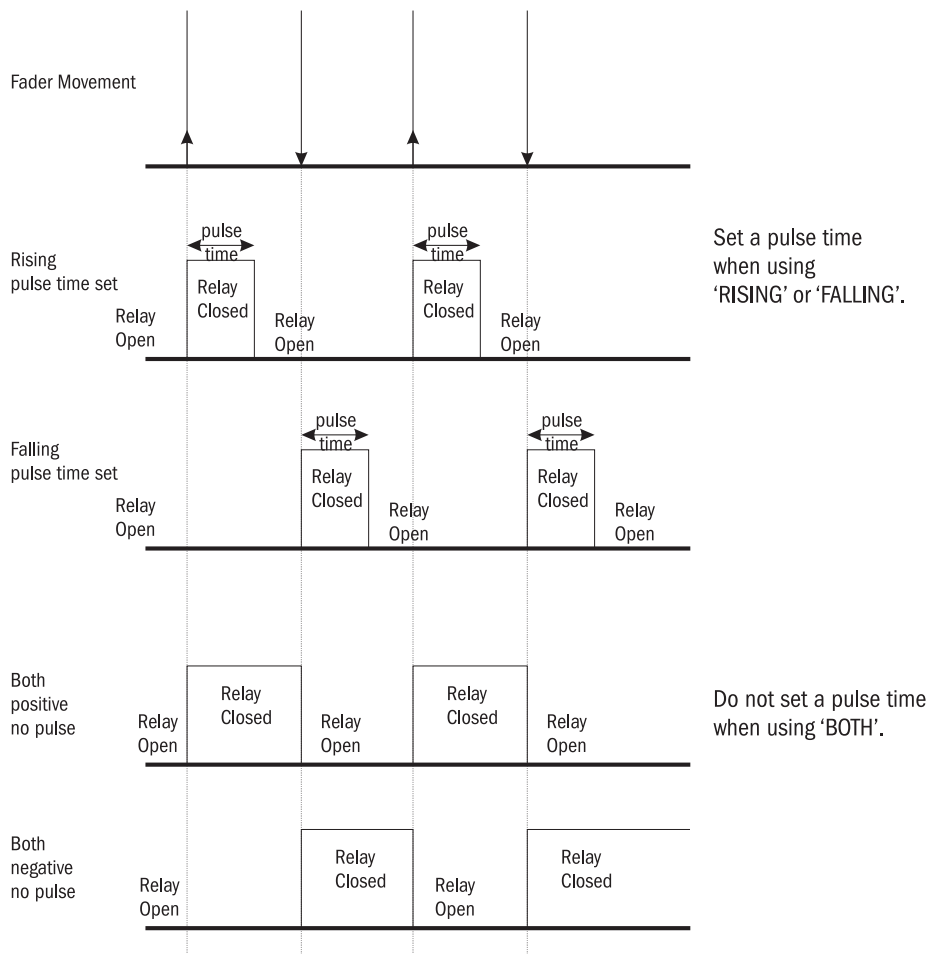
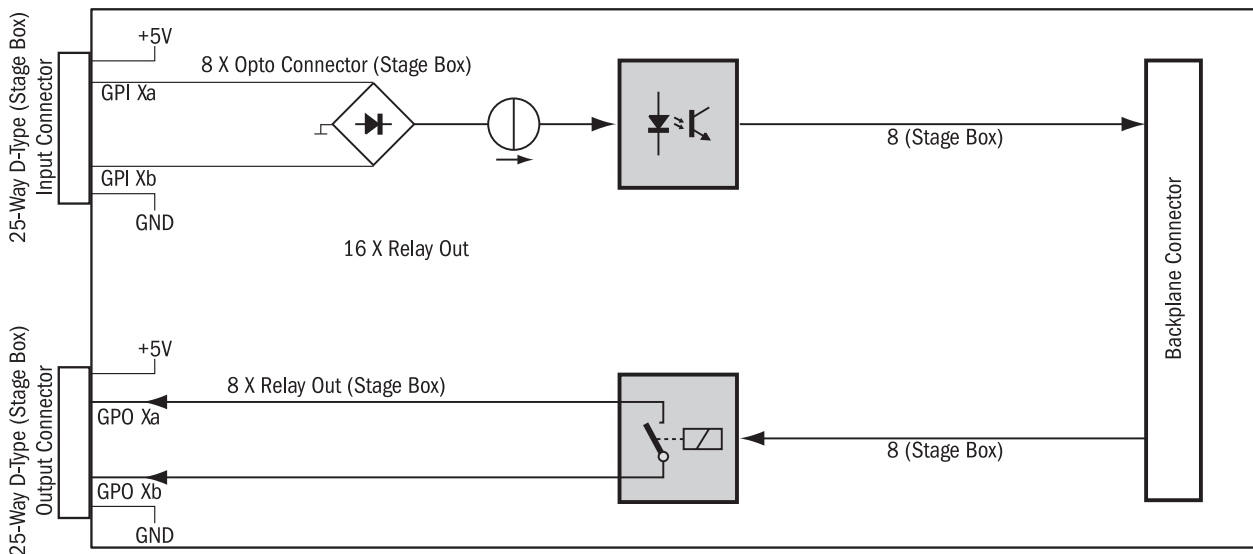

Figure 16-2: Relay timing diagram.

HARDWARE

Schematic Diagram



For general-purpose applications requiring total electrical isolation, the GPIO card provides electrically-isolated opto-coupler inputs with integrated current sink (5 to 24 VDC) and electrically isolated outputs using SPST relay contacts.

5 VDC and Gnd supply pins are provided.
Inputs and outputs are on standard D-type connectors (female).

Inputs

Control inputs (GPI Xa/b) are completely independent and electrically isolated. They may be used either with the internal +5 VDC supply voltage, or with external voltages of 5 to 24 VDC, regardless of the polarity. Total current supplied by all +5 VDC pins of one card must not exceed 600 mA.

Outputs

Control outputs (GPO Xa/b) are completely independent, electrically-isolated relay contacts, closed if active. Contact rating is 0.5 A for 125 VAC, 1 A for 30 VDC, or 0.3 A for 110 VDC. The +5 VDC supply voltage or the ground (GND) terminals, together with the relay contacts, may be used to generate an output signal. Total current supplied by all +5 VDC pins of one card must not exceed 600 mA.

Pin Lists

STAGE BOX

INPUTS

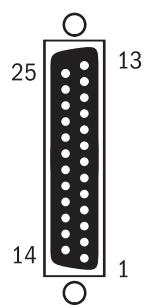

Pin	Signal	Pin	Signal
		13	GND (0V)
25	VCC (+5V)	12	GND (0V)
24	VCC (+5V)	11	GND (0V)
23	VCC (+5V)	10	GND (0V)
22	VCC (+5V)	9	GND (0V)
21	GPI 8b	8	GPI 8a
20	GPI 7b	7	GPI 7a
19	GPI 6b	6	GPI 6a
18	GPI 5b	5	GPI 5a
17	GPI 4b	4	GPI 4a
16	GPI 3b	3	GPI 3a
15	GPI 2b	2	GPI 2a
14	GPI 1b	1	GPI 1a

OUTPUTS

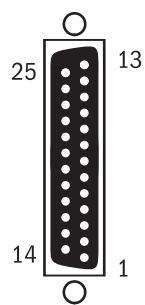

Pin	Signal	Pin	Signal
		13	GND (0V)
25	VCC (+5V)	12	GND (0V)
24	VCC (+5V)	11	GND (0V)
23	VCC (+5V)	10	GND (0V)
22	VCC (+5V)	9	GND (0V)
21	GPO 8b	8	GPO 8a
20	GPO 7b	7	GPO 7a
19	GPO 6b	6	GPO 6a
18	GPO 5b	5	GPO 5a
17	GPO 4b	4	GPO 4a
16	GPO 3b	3	GPO 3a
15	GPO 2b	2	GPO 2a
14	GPO 1b	1	GPO 1a

GENERAL

Soundcraft FaderGlow™ (Pat. Pend.) is a unique feature that gives the user an additional level of status indication, and can significantly reduce operating errors.

On the console, several different functions can be assigned to a particular fader, it can therefore be easy to forget which function is currently being controlled, especially when grabbing a fader in a hurry. The main principle of the Soundcraft FaderGlow is therefore to indicate the actual function type that is currently assigned to a particular fader.

Soundcraft FaderGlow is fitted to all 24 Faders that can change their function.

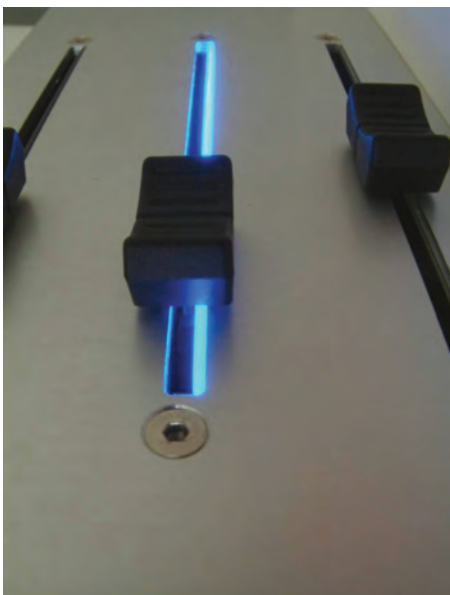

Figure 17-1: Soundcraft FaderGlow™.

Colour Code

FADER OPERATION	Soundcraft FaderGlow™ COLOUR
Channel level	NONE
AUX send level	ORANGE
GRP (fader closed)	GREEN
MTX contribution level	CYAN
VCA Master 1..8	BLUE

COPY, PASTE & LIBRARIES

INTRODUCTION

The Copy/Paste function allows the settings of any channel, bus, FX section or processing element to be copied and pasted to any number of other channels, saving set up time and helping eliminate errors. The last paste operation can be quickly reversed with an UNDO function. Processing blocks (eg EQ) or even individual parameters (eg mic gain control) within a processing block are selected for copying via touch screen selection on the same Vistonics screens that are used for audio control functions. A range of channels or busses can also be easily copied and pasted to another area of the desk.

The Library functionality allows you to select any set of parameters in use on the desk, ranging from a single channel's EQ setting, to a range of channels set up for a drum kit, to be stored in the internal library and recalled at will. The libraries can be exported to, or imported from, the USB memory stick, allowing you to build up your own portable channel and processing element libraries that can easily be transferred to any Vi console you need to work on.

This is done independently of the Show Files which allow entire desk settings to be exported. The console's default Library includes a selection of factory default library items for a number of common sources, plus a set of 'Flat' channels and processing elements which can be used for resetting areas of the console to default state when it is not desirable to reload a complete Default Show.



If the console is in either copy or paste mode a **yellow bar** appears across all the Input Screen areas and the console switches into 'Copy/Paste' mode, where the surface is used for selection. **Note that in these modes control of channel strip audio from the Vistonics™ screen is not possible!**

CONSOLE CONTROL KEYS

The EDIT keys on the control surface are used to initiate COPY and PASTE modes.

[Copy] mode is used for **source** selection.

[Paste] mode is used for **destination** selection.

[UNDO] can be pressed after a PASTE operation to restore the previous settings. If you wish to do this note that [UNDO] must be pressed before PASTE is switched off.

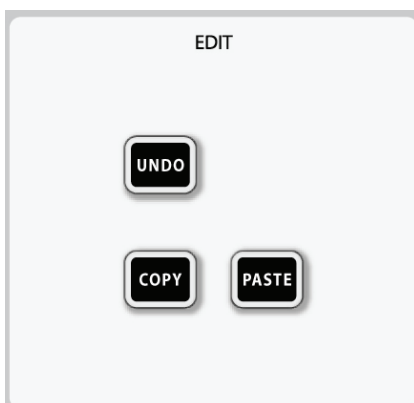

COPY & PASTE PRINCIPLES

In COPY mode, it is necessary to select the required items. Selecting them places the items onto the clipboard. Single or multiple channels or busses can be collected, or single or multiple elements from within the same channel or bus can be collected.

DATA SELECTION & INDICATORS

Full Channel



A full Channel can be selected in both COPY and PASTE modes by pressing the [SEL] Key. A range of full Channels can be selected by holding the [SEL] Key of the first Channel and pressing [SEL] of the last Channel.

The grey Channel border is replaced with a yellow border to indicate a whole Channel selection.



The SEL keys illuminate in blue, in COPY or PASTE modes, to indicate their function as selects rather than as a Solo.



Function blocks

In COPY mode, the selection of a function block can be toggled by touching the Touch field. Indication that a whole function block is selected is shown with a wide yellow indicator in the top left corner of the field.

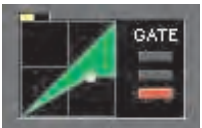

If only a set or a single Parameter from within this block is selected then a small yellow indicator is displayed.



Parameters

A single Parameter can be selected by touching the corresponding VST touch area. The selected state is indicated with yellow text in the Parameter Label. Note that not all parameters can be selected individually; in some cases a set of parameters will automatically be selected when one of the set is touched.

The parameter name will change to yellow text to indicate that it is selected.



HINT: You can enter the 'Zoom' mode where individual parameters can be selected, with a long press on a touch field. Alternatively you can enter the Zoom mode, before you activate Copy mode, by pressing the touch field in the normal way and entering 'Zoom' mode.

COPYING CHANNEL OR BUS PARAMETERS

- Press [COPY].
[COPY] lights.
- Collect Channel Parameters by pressing [SOLO/SEL] for the whole Channel
or
Touch Fields for functional groups like EQ
or
Long press on Touch fields to enter Zoom mode for individual Parameters.
Parameters are copied to the clipboard.
- Press [PASTE].
[PASTE] lights, [COPY] will be switched off.
- Select the destination channel by pressing [SOLO/SEL]
or
touching any VST field on the channel.
The clipboard content is immediately copied to each selected channel.
- End the function by pressing [PASTE] again.

The same procedure can be used for busses: you must be in the ALL BUSSES fader page to collect functional groups or parameters

COPYING A BUS MASTER INCLUDING ALL CHANNEL SEND LEVELS

- Press [COPY].
[COPY] lights.
- Select a Bus Master with [SEL]. This can be done either in the central output fader section (pages A-D), or the ALL BUSSES page.
- Press [PASTE].
[PASTE] lights, [COPY] will be switched off.
- Activate “include send levels” in the central page (choose YES).
- Select the destination Bus with [SEL].
- End the function by pressing [PASTE].



HINT: Bus copy can be performed between different Bus Types (AUX<>GRP, GRP<>AUX). In this case the ON/OFF state of the AUX sends will be equivalent to Group Routing ON/OFF.

PARAMETERS NOT INCLUDED IN CHANNEL & BUS COPY MODES

When you copy a whole channel, a whole bus, or the input and output blocks within the channel or bus, not all parameters are copied. For example if a whole channel is copied, the Input patch, gain, Insert and direct out settings are NOT copied.

The sections below list the various parameters that are NOT included if the whole channel or bus is selected for Copy using the SEL button.



Note that additional parameters can be added to –or subtracted from– the channel copy by using the ‘long-press’ on the touch screen in the required field and then selecting or deselecting various parameters.
It is never possible to select the Insert point or Direct Out however.

CHANNEL COPY: ITEMS NOT INCLUDED IN COPY WITH SEL BUTTON

- Input 1/2 switch
- Input 1 & 2 patch
- Mic Input Gain
- All associated switches (48V, PAD, Phase Inv etc)
- Insert Point – all aspects
- Direct Output – all aspects
- Fader and Mute
- VCA & Mute Group Assignment
- FX settings

BUS OUTPUT COPY: ITEMS NOT INCLUDED IN COPY WITH SEL BUTTON

- Output patch
- Insert Point – all aspects
- FX settings

Note that the Aux send levels (or routing switch status for Groups) from input channels to a bus also always copied when the bus master is copied, but you can choose whether to paste the sends or not using the {INCLUDE SEND LEVELS} key in Paste mode.



EXAMPLE: COPYING A WHOLE CHANNEL, INCLUDING THE 'IN1 PATCH' PARAMETER

- . Press [COPY] to enter Copy Mode
- . Press [Solo/SEL] button on required input channel to select it to the clipboard.
- . Touch the Input touch field on the channel strip with a long press (2s) to enter the 'zoom' mode for the input parameters. Notice that only the Trim, Filters and Delay parameter are already selected (indicated by yellow text).
- . Touch the encoder (or press the adjacent Vistonics button) in the IN1 PATCH field to add the patch parameter to the copied items.
(the IN1 PATCH text changes to yellow to indicate selection)
- . Press PASTE and select the destination channel(s) to paste the selected channel including the patch setting.

COPYING FX PARAMETERS

Parameter settings from any of the 4 internal Lexicon FX units can be copied from one device and pasted to another.

To make selection of the source and destination units easy, a set of 4 *FX-select screens* appears on the upper section of the Vistoonics screen in both Copy and Paste modes. The selection is made by touching the relevant Vistoonics screen section by the FX unit.

Alternatively, if the FX unit is assigned to a channel or bus and is therefore visible on the channel or bus strip, then the source and destination units can be selected by touching the FX block on the channel strip.

Note that only the parameters relating to the currently active FX Type are copied and pasted for each unit – so for example if LEX1 is currently set to the Small Hall FX type, then only the Small Hall parameters will be copied, if LEX1 is selected to copy.

When the settings are pasted to another unit, the target unit will have its FX Type changed to Small Hall, and only the Small Hall parameters will be pasted. None of the other 28 FX Types within the target FX unit will have their settings changed.

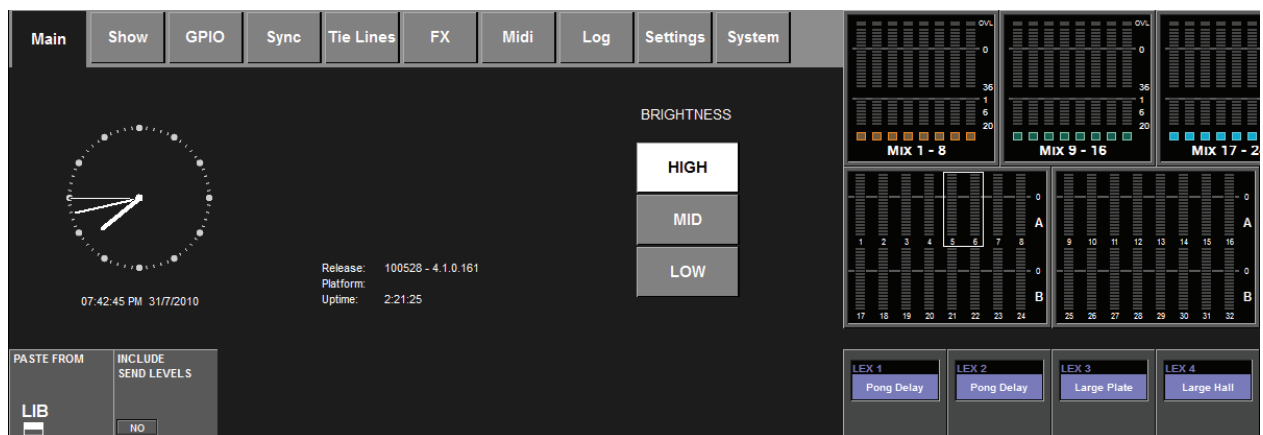

- Select the required FX Unit, either using the FX Select Encoders displayed in the central screen, or touching the FX unit's icon on the Channel or Bus strip, if one has been assigned and is visible on the strip.

Parameters are copied to the clipboard

- Press [PASTE]
- Select the destination FX unit by touching the required FX Select Encoder (or adjacent button) in the central screen.
 - or
 - touching any touch field on the target channel or bus strip.
 - or
 - pressing [SOLO/SEL] on the target channel or bus

The FX unit settings on the clipboard are immediately copied to the destination FX unit.

- The operation can be undone by pressing [UNDO], before exiting Paste mode.
- End the function by pressing [PASTE] again.

LIBRARIES

The *Libraries* functionality enables various elements of the console, eg EQ section, Dynamics section, or complete channels and busses, to be copied from the desk and stored in the Library system. Later these items can be retrieved and pasted from the Library to any destination channel or bus on the console.

The ability to export complete Libraries or individual entries to a USB stick allows you to extract saved items from the console and later import them to another console.

The Library system comprises a system of folders that reside on the console's internal flash drive. The folder structure is preset to comprise a top-level *Library* folder, within which are sub-folders called *Categories*, corresponding to the various types of functions that can be stored in the Library (eg: EQ, Dynamics, Channel, etc).

Within each *Category*, the actual Library settings are stored - these are called *Entries*. This structure and the names of the folders are fixed and cannot be modified. The folder structure is as follows:

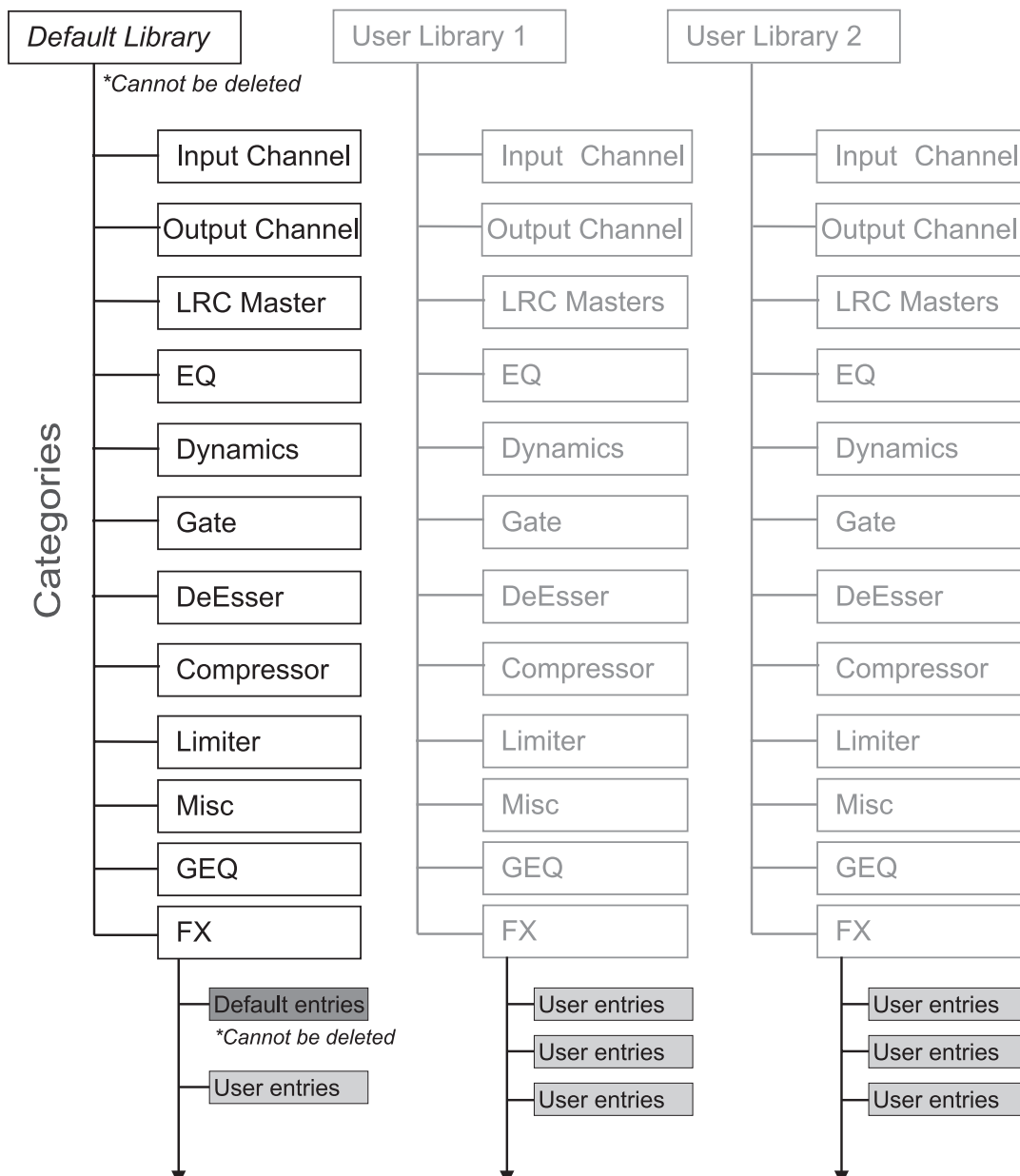

Default Library

The console comes with one pre-installed Default Library.

This Default Library contains factory presets for a variety of common applications. These factory default library entries are 'read-only' and cannot be deleted.

A mechanism exists for the default entries in the Default Library to be updated via a special update procedure. New, modified or additional default entries may be released from the factory from time to time. The update will be in the form of a web download which can be copied to a USB stick and transferred to the console. This may be included as part of the routine software updates for the console.

New Entries can be stored in the Default Library, alongside the read-only factory default Entries, or one or more new Libraries can be created which will then only contain user-stored Entries.

User Libraries

In addition to the Default Library, as many additional new Libraries can be created as required. Either a new empty Library can be created or the existing Default Library can be duplicated using the Save As function, creating a new Library that also contains the factory default Entries.

When a new empty Library is created, only the folder structure is created – the Library itself contains no Entries and needs to be populated by the user.

The only limit to the number of Libraries or entries that can be created is available disk space in the console, but the file size of each Library entry is very small (typically <100kB for individual single channel Entries).

It is recommended for easier data management that each user creates their own Library on the console, populates it with their personal settings and then exports the Library to their own USB stick.

The Library can then be imported to the next console, added to if required and then re-exported (see later section Exporting and Importing Libraries).

Categories

The list of Categories can be seen in the diagram on the previous page.

Categories in the Library structure are predefined and cannot be changed by the user.

Note that only items that have a Category can be stored to the Library – it is not possible to store every type of parameter to the Library! For example, there is no Category for the Input stage (gain, PAD etc) or the Aux send parts of the channel strip, so these parameters cannot be stored to the Library other than as part of complete channel strips using the InputChannel Category.

The Misc Category

Most Categories correspond directly to the console function of the same name, but the *Misc* Category requires further explanation.

This Category is intended for storing combinations of channel or bus parameters.

Currently, only a combination of **EQ and Dynamics** can be stored in the Misc category, but this may be extended with a future software update to allow storing of any of the various channel parameters which do not have their own Category, as well as any combination of these parameters.

NAVIGATING AND MANAGING LIBRARIES

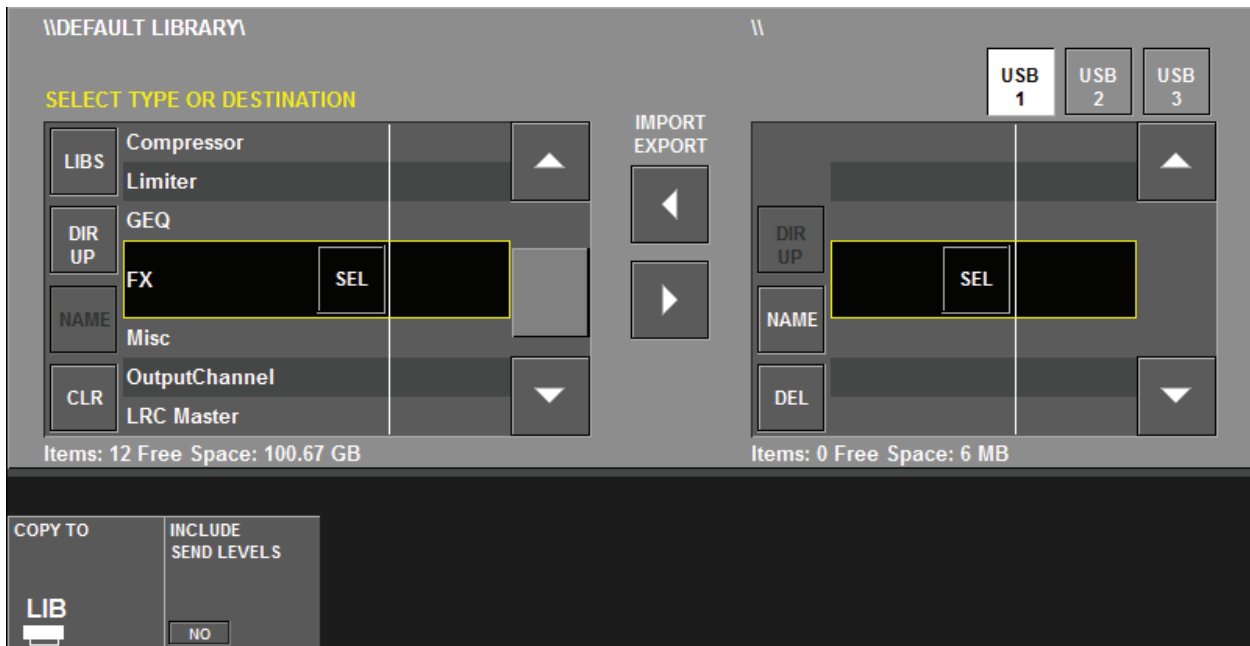

To perform operations on the Library, either the **Copy to LIB** page or the **PASTE from LIB** page must be opened. To do this, press either [COPY] or [PASTE] followed by the {LIB} key in the bottom left corner of the upper section of the Visonics screen.

TITLE info: The text line in the top left corner of the screen, beginning \\ always shows which Library and Category is currently selected.

{LIBS} Jumps to the top of the Library folder structure, regardless of whether the library is currently displaying Category or Entry level. Pressing {LIBS} when at the top *Library* level jumps back down to the previously selected Category level.

{DIR UP} Moves up the Library folder system one step with each press. There are three levels: *Libraries* (top) \ *Categories* \ *Entries* (bottom)

{SEL} Located in the selection bar, this button is used to drill down to the next level. At the top LIBS level, the {SEL} button selects the highlighted Library to be loaded. The currently loaded Library is indicated by its name being displayed in yellow text in the list.

{NAME} Opens the QWERTY keyboard to allow the name of the currently highlighted Library or Entry to be edited. Note that *Category* names cannot be edited, so the {NAME} button is greyed out at this level.

{DEL} Deletes the currently highlighted Library or Entry. Since the Category level folders cannot be deleted, the {DEL} button changes to become a **{CLR}** button when in the Category level. Pressing {CLR} will delete all Entries within that Category. Confirmation dialogues are displayed before all Delete or Clear operations. (facing page to previous screenshot)

SAVE AS button: Only displayed at the top *Library* level.

Saves a copy of the *currently loaded* Library, with a new name.

The QWERTY keyboard is opened to allow the new name to be entered.

NEW button: Only displayed at the top Library level.
 Creates a new empty Library with the default name **newLib_x**.
 The new Library contains only the folder structure, but no Entries.

COPY TO LIBRARY

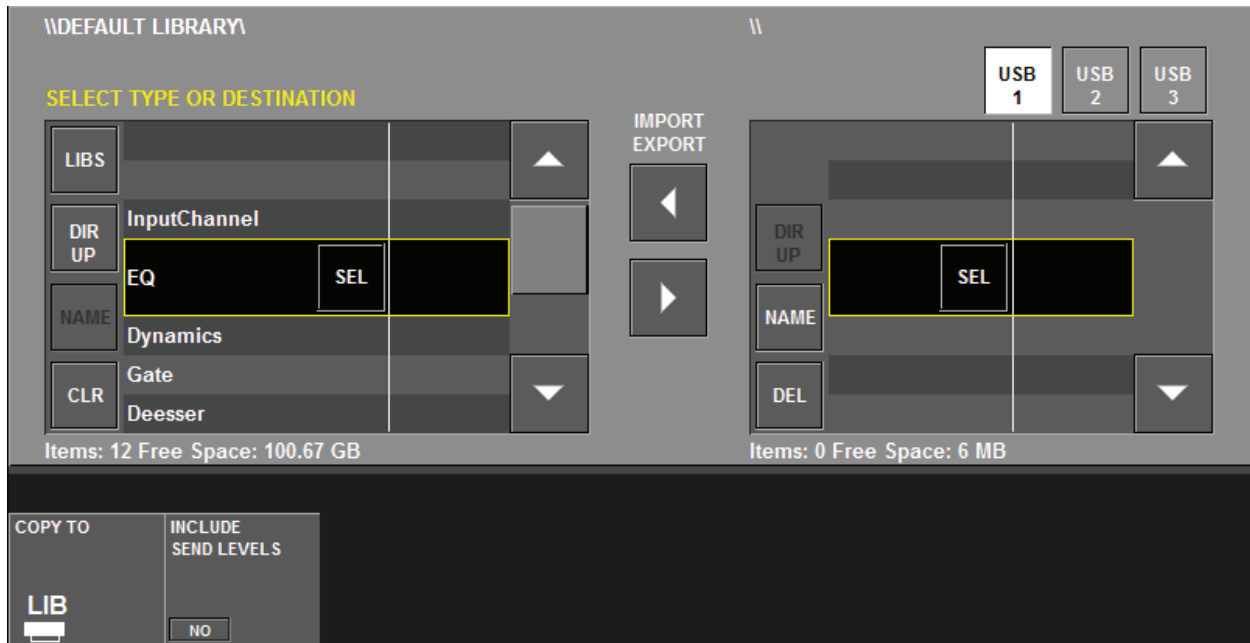

Copying an EQ to the library

- Press [COPY] on DESK
 - Press {LIB} key in “COPY TO” field in the central screen
 - Touch the EQ touch field on an input or output channel strip
- The library will **automatically** change to the EQ library*
- A new library item will automatically be stored in the EQ category, with the name newItem_x
 - Press <NAME> to open the QWERTY keyboard and rename the new item
 - Press [COPY] on DESK to return the console to normal operation.

PASTE FROM LIBRARY

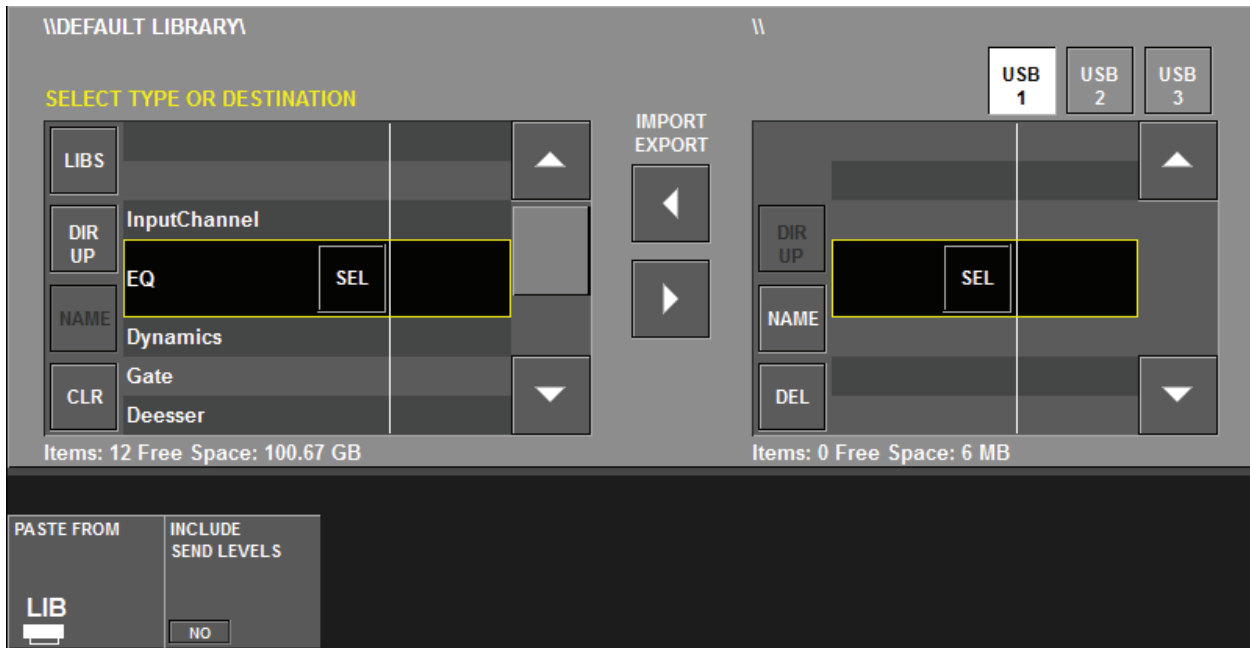

Pasting an EQ from the library

- Press [PASTE] on DESK
- Press {LIB} in "PASTE FROM" field in central screen

Method 1

- Select the desired Library /EQ and the desired library entry in the list
- Press [SEL] or the EQ Touch field on the destination Channel to load the Equaliser settings to that channel.

Note: it does not matter which touch field is touched on the destination channel – as the system already knows an EQ has been selected from the library, it only needs to know which channel you want to paste it to.

Method 2

- Touch the EQ field on an input or output channel' strip. A yellow marker will appear in the touch field border to indicate selection
The library will automatically change to the EQ library category, and the available EQ entries will be visible
- Press <LOAD> within the library list on the central screen to load the EQ to the Desk

EXPORTING AND IMPORTING LIBRARIES

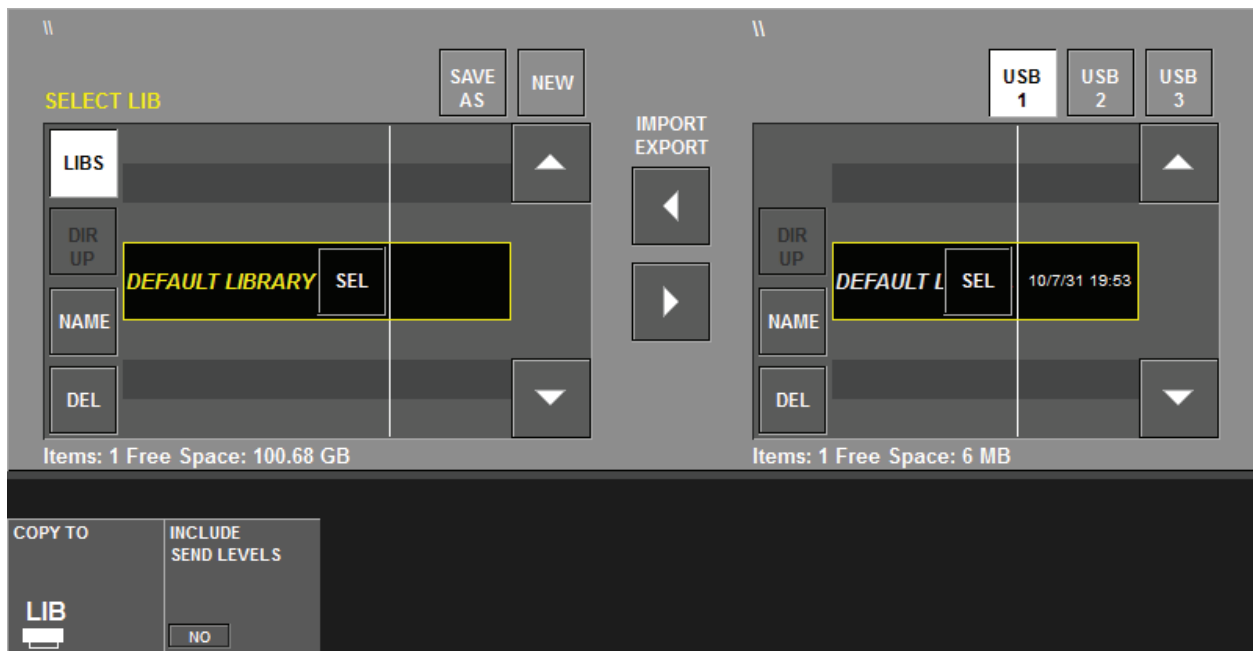

If a USB memory device is inserted into one of the console's USB ports, an additional window will be visible on the right-hand side of the Library page, as shown above.

This right-hand window shows the contents of the USB memory device, which will initially be empty if it has no Libraries stored on it. The {USB1-3} buttons can be used to select the required memory device if more than one storage device is connected.

Exporting

Complete Libraries

To export a Library to the USB memory device, press the {LIBS} button to move to the top of the console's internal Library structure, and use the {scroll arrow} buttons to position the cursor on the required Library in the left-hand window.

Press the {right-arrow} button between the two windows to export the selected Library to the USB memory device.

Exporting the Library creates a new folder called *Libraries* on the USB stick, and then copies the entire Library folder structure to that folder on the USB stick

The folder structure can be examined later on an external computer, and a copy made for archiving/back-up purposes.

Entries

To export an individual Entry to the USB stick, the full Library folder structure must already be present on the stick.

Using the {DIR UP} or {SEL} buttons, position the cursor on both the internal Library and the USB stick at the same level – showing Entries.

Then use the {right-arrow} button between the windows to copy the selected Entry to the USB stick.

Importing

To import a Library or Entry from the USB stick, simply use the cursor {scroll arrow} buttons to select the required Library on the USB stick in the right-hand window.

Then press the {left-arrow} button between the windows to copy the selected Library to the console. A dialogue box indicates the progress of the copy operation.

SOUNDCRAFT Vi1™ FEATURES AND SPECIFICATIONS

AUDIO CHANNELS

Max number of simultaneous mixing channels

Soundcraft Vi1 standalone: 32 mic/line + 4 AES + 2 S/PDIF +8 FX Returns = 46

Soundcraft Vi1 with stagebox: 64

Insert points

24 insert send/return pairs can be configured (using available I/O) and assigned to any of the 64 inputs or 27 output channels

Direct Outputs

All input channels can have direct outputs in addition to their internal bus routing, assuming sufficient I/O is available (eg via 64ch optical MADI card, see below)

Busses

24 Grp/Aux/Matrix*, plus main LCR Mix and LR Solo busses.

* a maximum of 8 matrix outputs can be configured.

I/O CAPABILITY

The following I/O is available and can be patched to any channel input, direct output, bus output or insert point as required:

Console Inputs & Outputs

32 analogue mic/ line inputs

1 Talkback Mic input (mounted on control surface)

2 pairs of AES/EBU inputs (= 4 channels)

1 S/PDIF input (= 2 channels)

24 Bus Line outputs

3 Master Line outputs (L, R, C)

2 sets of Monitor outputs (Main L, R, C; ALT L, R)

2 pairs of AES/EBU outputs (= 4 channels)

1 S/PDIF output (= 2 channels)

Optional Cards

64ch MADI In via optical SC connectors or Cat5, for stage box connection or recording feed.

Any other card from Studer D21m range.

MIDI

1 MIDI Input and 1 MIDI Outputs on rear of control surface.

CHANNEL PROCESSING

Inputs

Analogue gain (remote control of local or stage box mic preamp)

Digital Gain Trim (+18/-36dB)

Delay (0-100ms)

HPF, LPF (variable 20-600Hz and 1-20kHz)

4-band fully parametric EQ, shelf mode on HF/LF.

Compressor (variable threshold, attack, release, ratio, makeup gain with 'auto' mode)

Limiter (variable threshold, attack, release)

Gate or De-Esser. Gate switchable to ducker.

Insert point for external processing.

Pan - LR or LCR switchable.

Direct Output, patchable to any I/O and with selectable tap-off point.

Outputs

HPF (variable 20-600Hz)

4-band fully parametric EQ, shelf mode on HF/LF.

Compressor

Limiter

Delay (0-1sec)

Insert point for external processing.

Pan (Output bus to LCR) - LR or LCR switchable.

Graphic EQ 1/3-octave

Assignable Lexicon Multi-FX processors x4

CONTROL SURFACE

Inputs

16 input faders, switchable in 4 fixed and 5 user-configurable layers to access up to 64 inputs.

Widescreen Vistonics™ channel strip interface, controls 16 input channels.

Fader tray contains motorised fader, Mute, Solo, Isolate and F (user defined) switches.

Input level and gain reduction meter is located above each fader.

Input faders can be assigned to the 8 VCA (control group) masters and/or 4 Mute Groups.

Input faders can be switched to control all 24 Grp/Aux/Matrix Outputs, or can control an individual Aux send mix, using the switchable 'Follow Solo' function. Soundcraft Fader Glow™ clearly indicates using colours when faders are not controlling inputs.

Outputs

8 assignable Output faders, plus 2 dedicated LR and C Master faders, plus 16 assignable rotary Output faders. Output faders are colour-coded using Soundcraft Fader Glow.

Output faders can be assigned to the 8 VCA (control group) masters and/or 4 Mute Groups.

Misc

Gang mode for temporary linking of any number of channels for quick adjustment and setup

Controls for Mute Group and VCA Group assignment.

Controls for assignment of Vistonics rows to bus sends (when channel parameters are not selected to Vistonics).

Snapshot automation controls

Talkback & Oscillator controls

Controls for Monitor Output level, phones level and Solo Trim and blend level.

Copy & Paste controls

Soundcraft Vi1™ TYPICAL SPECIFICATIONS

Frequency Response	
Stagebox Mic input to Line output	+0/-1dB, 20Hz-20kHz
AES/EBU In to AES/EBU Out	+0/-0.2dB, 20Hz-20kHz
T.H.D. & Noise	
22Hz-22kHz	<0.01% @ 1kHz
Local Mic In (min gain) to Local Line Out	<0.003% @ 1kHz
Stagebox Mic In (min gain) to Local Line Out	<0.020% @ 1kHz
Local Line In to Line Out	<0.003% @ 1kHz
Mic Input E.I.N.	<-125dBu (150 Ohm source)
22Hz-22kHz bandwidth, unweighted	
Residual Noise	-95dBu
Stagebox line output; no inputs routed, Mix fader @0dB	
CMRR	80dB @ 1kHz
Stagebox Mic input	
Sampling Frequency	48kHz
Latency	
Stagebox Mic Input to Local Line output	< 2ms @48kHz
AES/EBU Input Sample Rate	32-108kHz (with SRC enabled)
DSP resolution	40-bit floating point
Internal clock	
Accuracy	< +/-50ppm
Jitter	< +/-5ns
External Sync	BNC Wordclock
Input & Output Levels	
Mic Inputs	+25dBu max
Line Outputs	+22dBu max
Nominal Operating Level	0dBu (-18dBFS)
Input & Output Impedances	
Mic Inputs	2k7Ω
All other analogue Inputs	>10kΩ
Line Ouptuts	<75Ω
AES/EBU Outputs	110Ω
Oscillator	20Hz to 20kHz/Pink/White Noise, variable level

Channel HP filter	20Hz-600Hz, 18dB per octave
Channel LP filter	1kHz-20kHz, 18dB per octave
EQ (Inputs and bus Outputs)	HF: 20Hz-20kHz, +/-18dB, Q= 0.3-8.7 or shelving Hi-Mid: 20Hz-20kHz, +/-18dB, Q=0.3-8.7 Lo-Mid: 20Hz-20kHz, +/-18dB, Q=0.3-8.7 LF: 20Hz-20kHz, +/-18dB, Q= 0.3-8.7 or shelving
Metering	Internal 10-segment LED bargraphs plus 4-segment gain reduction meters for all inputs and Outputs. Peak hold variable from 0-2s.
Mains Voltage operating range	90-264V, 47-63Hz, autoranging
Mains Power Consumption	
Vi1 Console:	155W
Weights (without flightcases)	
Vi1 Console:	35kg (77lb)
Operating Temperature Range	0°C - 45°C (32°F - 113°F)
Relative Humidity	0% - 90%, non-condensing $T_a = 40^\circ\text{C}$ (104°F)
Storage Temperature Range	-20°C - 60°C (-4°F - 140°F)

Soundcraft reserves the right to make changes to the above data without prior notice. E&OE.

General

The Soundcraft Vi1™ contains 4 powerful LEXICON® Effects Processing Units and 27 high-quality BSS® 30-band Graphic Equalisers.

LEXICON® Effects

Each Effects Unit can be inserted into any Output/Main Master bus or into any Input Channel, or it can be patched as an FX Return to an Input Channel, fed from an Aux send.

Each FX Unit supports up to 30 different professional LEXICON® Effects.

Effect Parameters can be easily changed via the Widescreen Vistonics™ screen at a location on the Surface corresponding to where the FX is inserted or patched. Additionally, the Parameters can be viewed and changed in the FX Overview Page in the main menu.

All Parameters from the 4 Effects Units and for all Effects Type are stored in the desk Snapshots.

BSS® Graphic Equalisers

The 27 BSS® 30-band Graphic Equalizers are permanently assigned to the 24 Output Busses and the three Main Masters. All Parameters from the GEQs are stored in the desk Snapshots.

LEXICON® Effects Format

Depending on the selected Effect Type, the FX processor works internally in one of three formats:

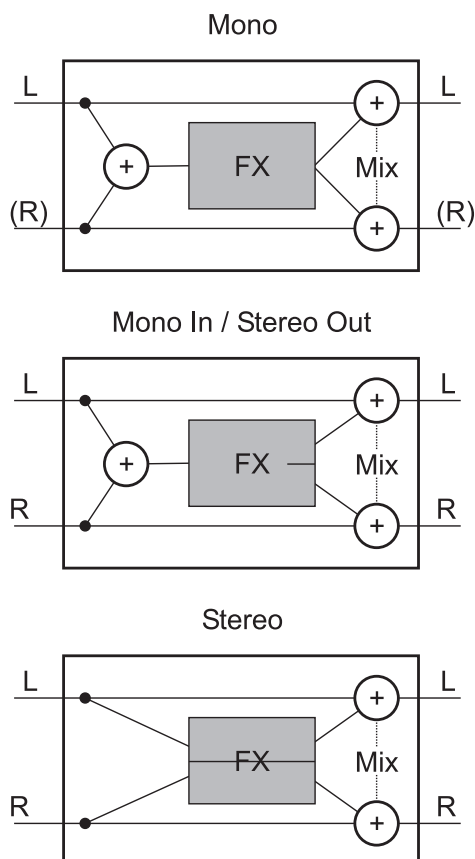

The FX processor always has Stereo Inputs and Outputs. If the FX Type needs only a Mono Input, the Left and Right Input Signal are summed together. If the FX Type outputs only a Mono Signal then the Output Signal is distributed to both the Left and Right Outputs.

The MIX Parameter adjusts the ratio between the original (dry) signal and the effects (wet) signal.

FX Overview Page

In the Overview Page all four FX processors are visible at the same time and can also be adjusted. The parameters available for adjustment will depend upon the type of FX which is selected. A description of the Effects and their associated controls is given in the section which starts on page 11 of this chapter. To enter the FX Overview Page press [MENU] and select the FX Tab.

The vertical white Bars on the Boxes represent the assignment mode : In INSERT mode the white bars are inside (example below LEX 1 = Channel Insert, LEX 2 = Master Insert). In PATCH mode the white bars are outside (exempld below LEX 3 = Patch). Note that the bars should both be outside or should both be inside.

The vertical white bars also indicate for each FX processor if a mono or stereo format is being used. In the example below LEX 1 is in a stereo format, all the others are in a mono format.

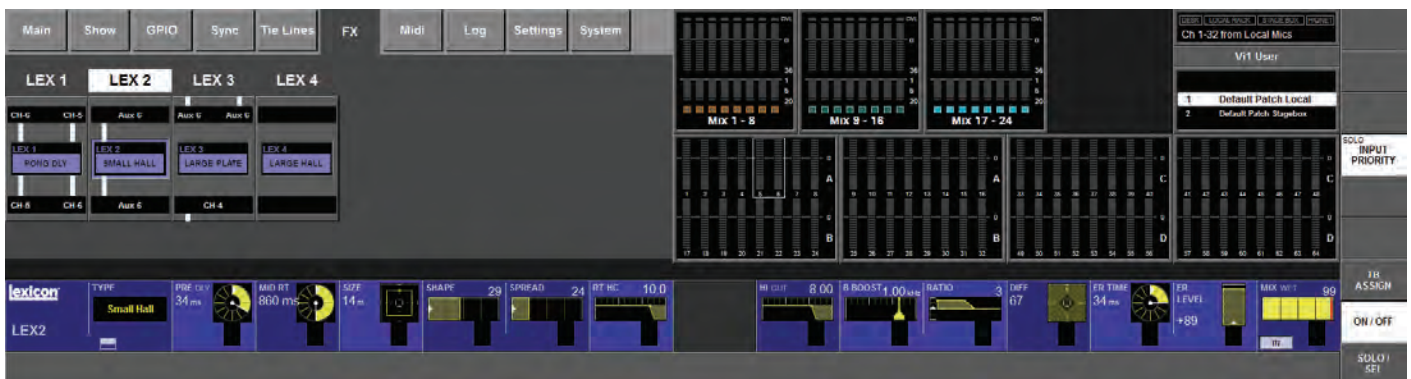

HINT. The assignment of the FX processors is visible, but cannot be changed from this page.

It is recommended that before assigning any FX processor this page should be viewed to find out what processors are free (if any). If it is necessary to unassign a processor in order to use it somewhere else it is strongly recommended that the user should unassign all patches to it before re-patching it in its new location.

Snapshot integration

All Parameters from all Effect Types for each of the four processors are stored in the console Snapshots. In the Basic implementation each of the 4 FX processors can be fully isolated.

TAP

For each effect that offers TAP Tempo (Tempo synchronisation using key press), the bottom left key is used as the TAP button.

ASSIGNING F1-6 KEYS TO FX TAP TEMPO

In live situations it is often advantageous to be able to easily control the TAP function from a large button which is permanently accessible on the console surface. The large F1-6 keys below the monitor section can now be used for this purpose.

The Virtual Pins (VGPI and VGPO) can be used as a way of assigning the F-keys and the F-key LEDs to internal functions in the console.

Currently it is possible to assign the F1-6 keys to remotely control the Lexicon TAP buttons of any of the four Lexicon FX units.

The Tempo signal from the Lexicon units can be assigned to the F-key LEDs, in order to provide a visual indication of the current tempo.

Changing the assignment of F-keys to TAP function

The first 2 Lexicon units LEX1 and LEX2 have their Delay TAP buttons assigned to F1 and F2 by default because these settings are stored within the read-only factory default Shows.

In order to assign the TAP functions of more FX units to the F-keys, proceed as follows:

- Press the [MENU] button and select the {GPIO} menu tab.
- Ensure the {LOCAL I/O} button is selected and scroll the input and output sections down to the VGPI and VGPO Pin settings. For LEX3, select VGPI Lex Tap3 and VGPO Lex Tap3.
- Set the parameters for the VGPI and VGPO as shown in the picture below, and ensure the input and output are switched ON.

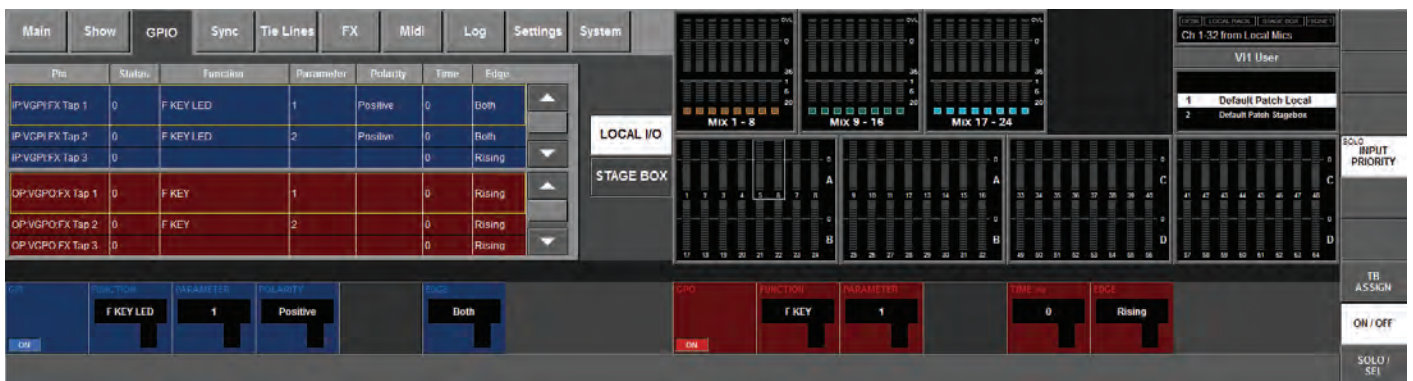

Use a similar procedure for other FX units. All 4 of the FX units can be assigned to any of the F1-6 buttons using this method. The settings will be stored when you save the current Show.

Assigning FX processors

The Vi1 supports three different ways to patch an FX processor:

- Insert in an Input Channel
- Insert in a Bus Master
- Patch as an FX return

Channel Insert

This Mode is used for Channel effects.

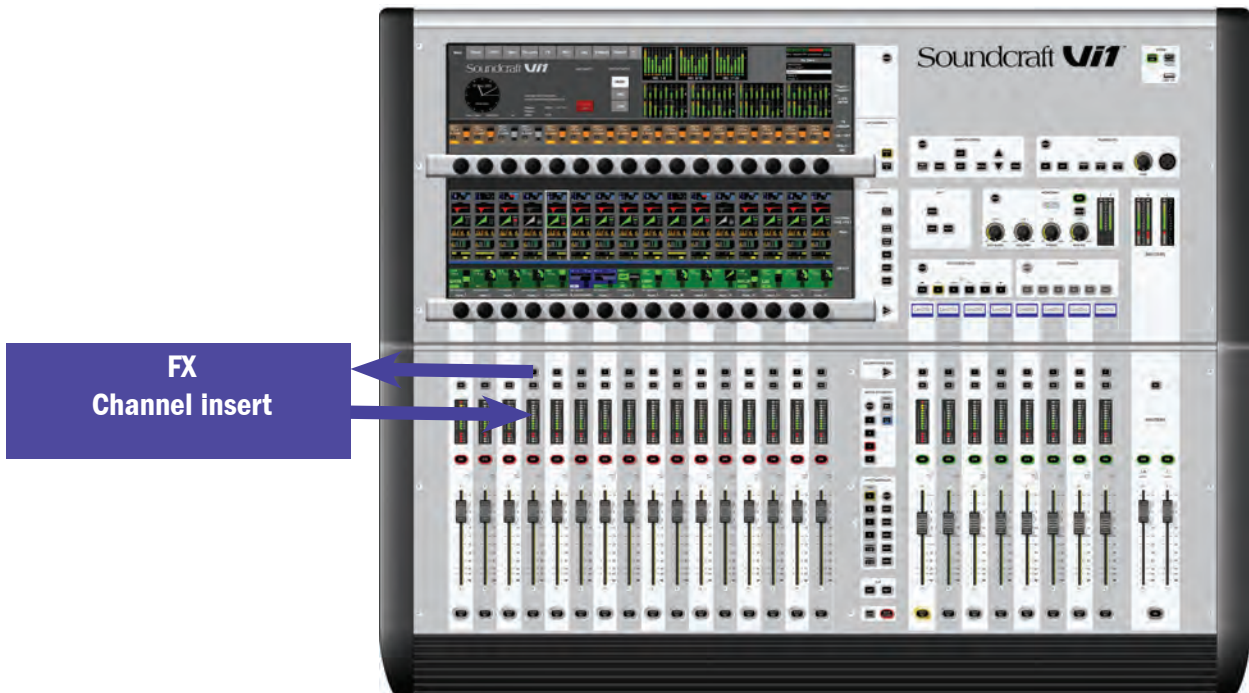

Insert a FX processor in a Input Channel

Touch the channel's <PAN> area for the required Input Channel.

Press the {INSERT} key to open the Insert Pool select page.

Pressing the <FX> button opens the FX selection options.

Select the desired FX processor. If the processor is in use, a dialog asks if you want to move it from its current location.

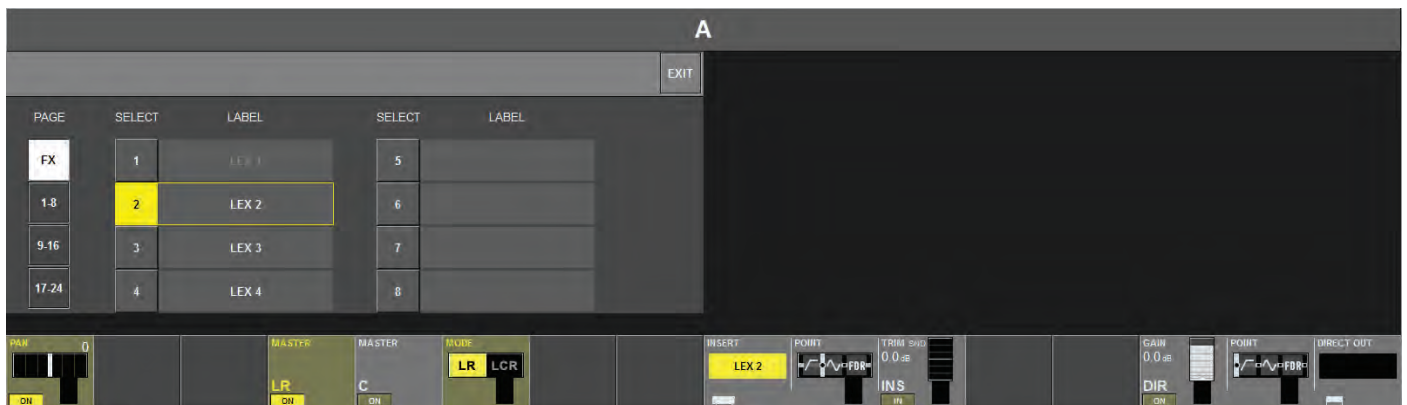

Pressing the <EXIT> key will return you to a page similar to below.
 Notice that the EQ area on the screen is now shared with an FX processor icon.
 Pressing the <PAN> area will return the screen to its normal display mode.

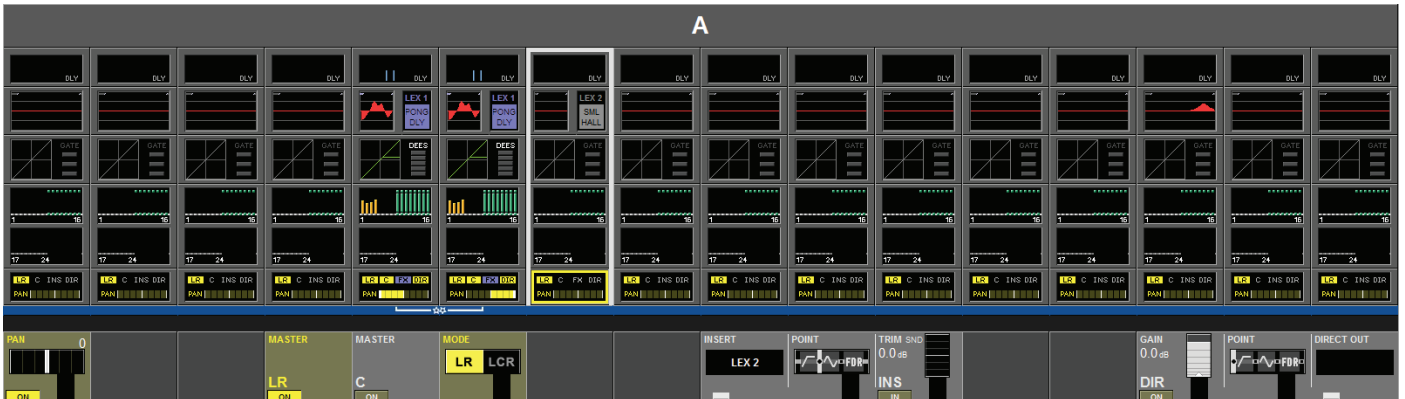

The FX processor can be adjusted by pressing the FX processor icon on the screen. The parameters available for adjustment will depend upon the type of FX which is selected. A description of the Effects and their associated controls is given in the section which starts on page 13 of this chapter.

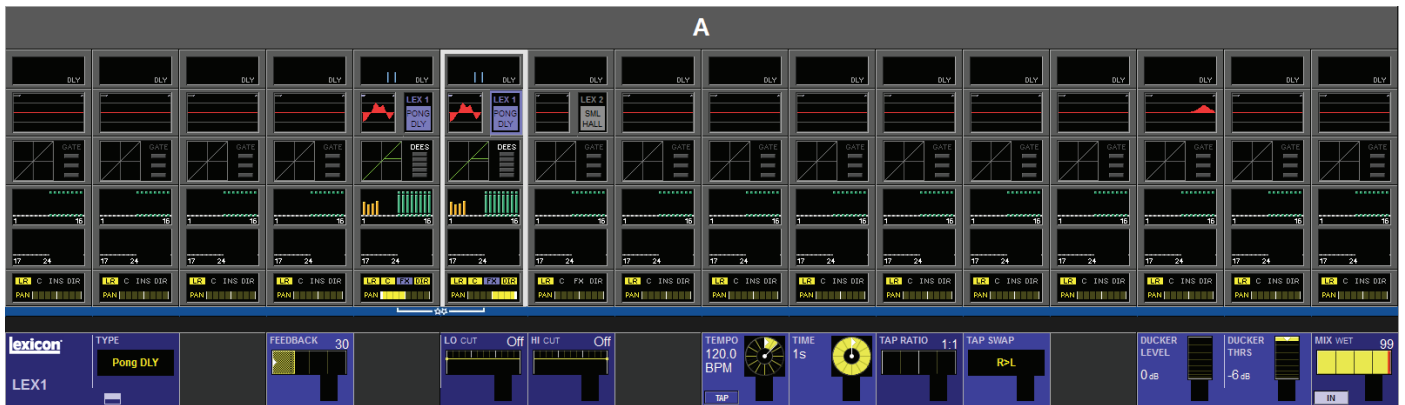

Aux Master Insert

This operation mode is an elegant way to use Reverb Effects without losing Input Channels for the Return signals.

In this Mode the FX processor is inserted in an AUX Master, and the AUX Master is assigned to the Main Master (LR).

The Input Gain of the FX can be adjusted with the Insert Send TRIM control and the effect amount can be adjusted with the Master Fader



HINT

You can use the AUX Master like an FX Return, because it has EQ and Dynamics that can be used on the output from the FX Units. (You must set the Insert Point to pre processing.)

Inserting an FX processor in an AUX Master Bus

Press the [BUSSES 1-16] or [BUSSES 17-24] key.

Press the <PAN> area on the required AUX Bus.

Press the {INSERT} key to open the Insert Pool select page.

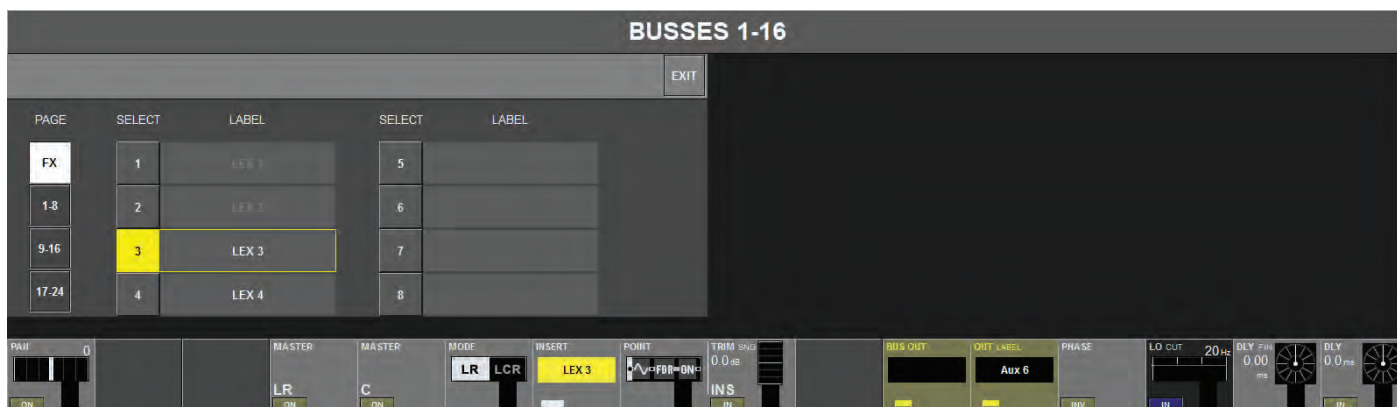

Pressing the <FX> button opens the FX selection options.

Select the desired FX processor. If the processor is in use, a dialog asks if you want to move it from its current location.

Press <Exit> to return to the page similar to that below. Notice that an FX processor icon appears in the FX area of the screen when an FX Processor is allocated to the AUX bus in question.

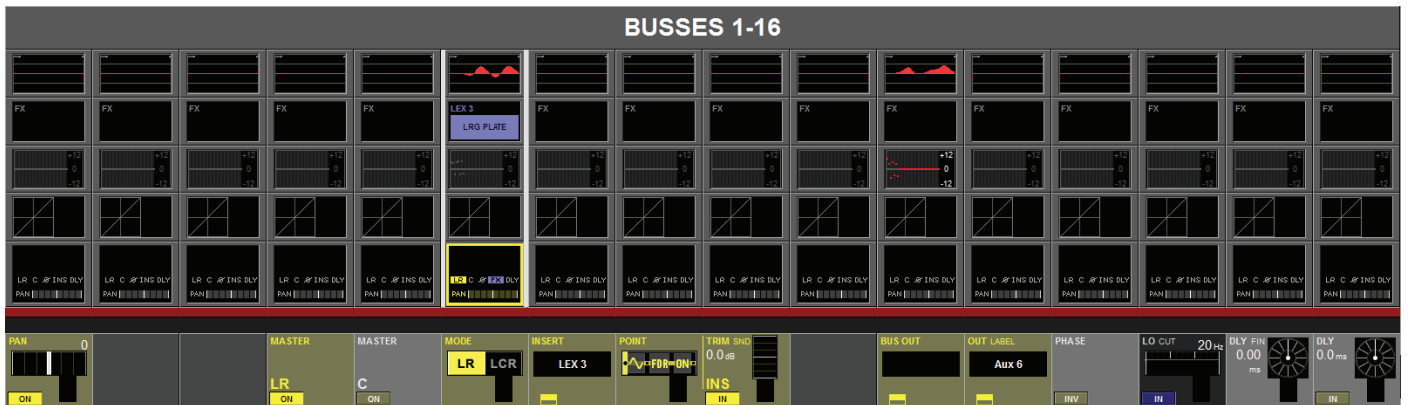

Press {LR} to route the FX signal to the Main Master bus.

Select the Insert {POINT} to be pre processing in order to use the EQ and Dynamics on the output of the FX.

Pressing the <PAN> area will return the screen to its normal display mode.

The FX processor can be adjusted by pressing the FX processor icon on the screen. The parameters available for adjustment will depend upon the type of FX which is selected. A description of the Effects and their associated controls is given in the section which starts on page 11 of this chapter.

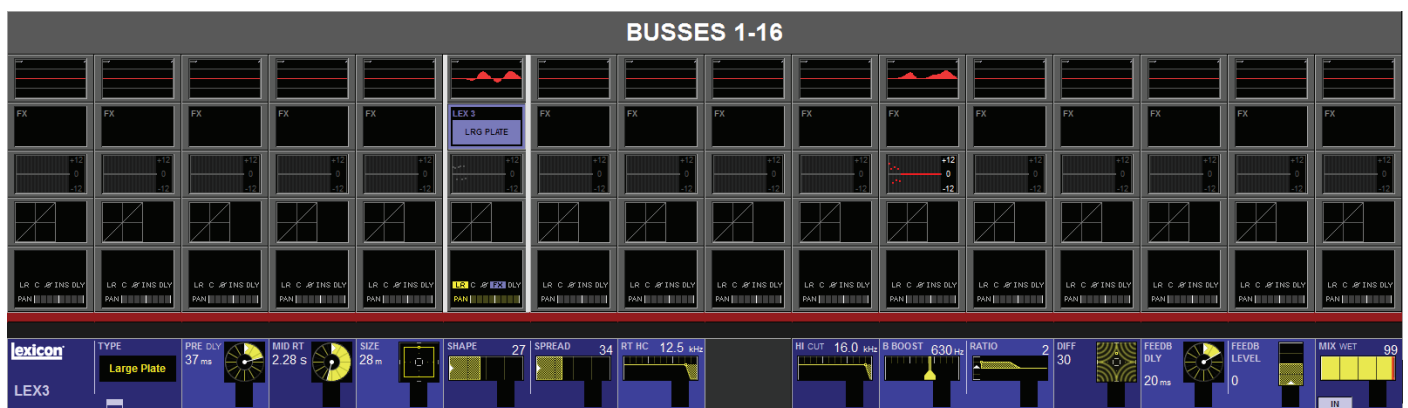

Return in Channel section

This is the classical operation mode for Reverb Effects. The Output of an AUX Master is patched to the Input of an FX Unit, and the Output of the FX Unit is patched to either a mono or 2 paired (Stereo) Input Channels that mixes the Reverb content to the Main Masters or other destinations.

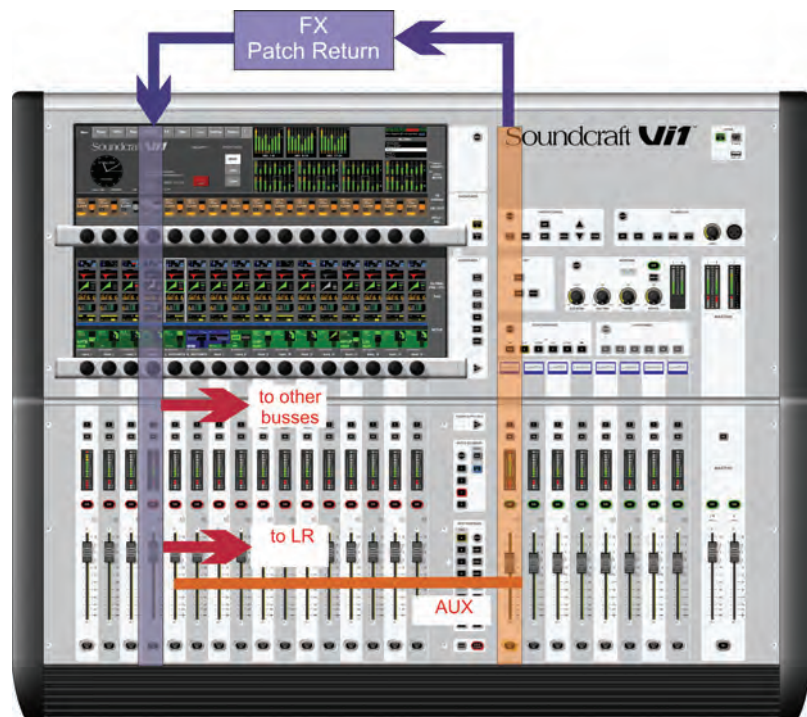

To patch an FX processor from an AUX Master to the Input section

Press either the [BUSSES 1-16] or [BUSSES 17-24] key.

Press the <PAN> area on the desired AUX Master bus.

Press the {BUS OUT} key to open the Output Patch page (see Figure 21-12). Press <Lexicon In> to open the FX selection options.

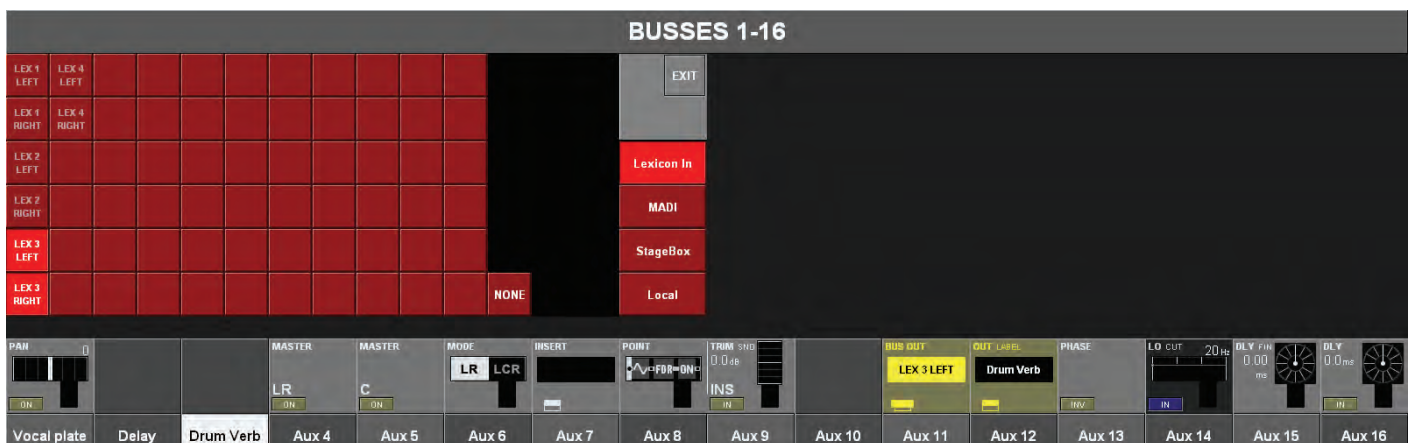

If the Aux bus is mono, you should select both Left and Right Lexicon In patches.

If the Aux bus is stereo, you should patch the Left bus out to the Left Lexicon In, and the Right bus to the Right Lexicon In. (The right bus will be patched automatically in this case)

Select the required FX processor. If the processor is in use, a dialog asks if you want to move it from its current location. Press <EXIT>.

Press one of the Fixed Fader Pages [A], [B], [C] or [D] keys to select the required bank of input channels.

Press the <INPUT> area on the desired return Input Channel.

Press {IN1 PATCH} to open the Input Patch page (see Figure 21-13). Press <Lexicon Out> to open the FX selection options.

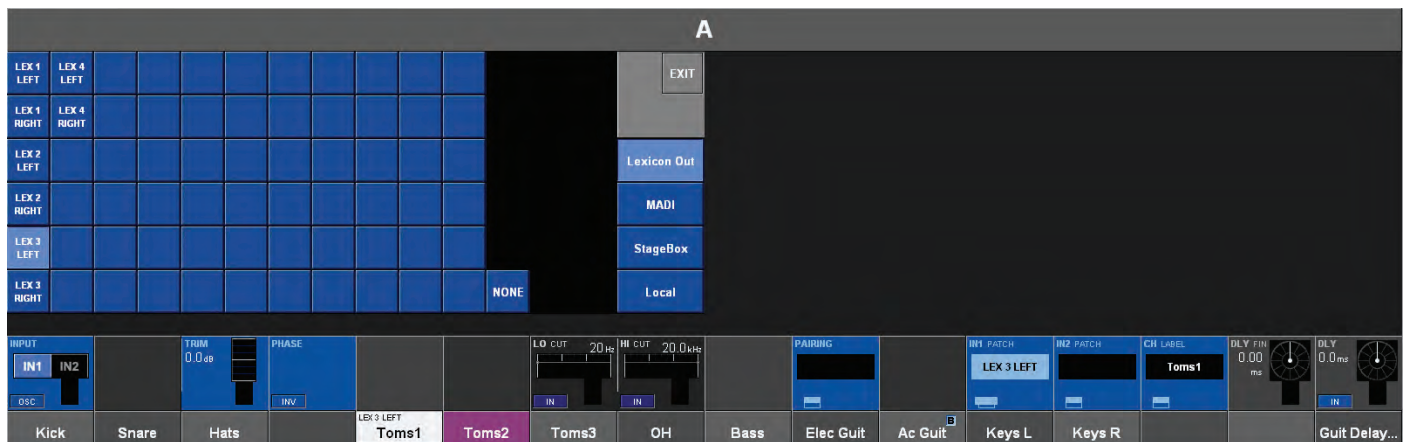

Select the desired FX processor. If the processor is in use, a dialog asks if you want to move it from its current location. Press <EXIT>.

FX TYPE

For each of the 4 FX processors an individual FX Type can be selected.

The FX Types are grouped into the following categories:

- REVERB
- DELAY
- MISC

A description of the Effects and their associated controls is given in the section which starts on page 11 of this chapter. This page is opened by pressing the {TYPE} button.



HINT: *Selecting an FX Type always loads the last user parameter settings for this Type.*

A

Small Hall	Small Plate	Chamber	Gated	Spring	TYPES EXIT
Large Hall	Large Plate	Room	Reverse		
Drum Hall	Drum Plate	Ambience			
Vocal Hall	Vocal Plate				

Reverbs
Delays
Misc

lexicon TYPE PRE DLV 34ms MID RT 860ms SIZE 14m SHAPE 29 SPREAD 24 RT HC 10.0 HI CUT 8.00 B BOOST 1.00kHz RATIO 3 DIFF 87 ER TIME 34ms ER LEVEL +89 MIX WET 98

LEX3 Small Hall

Kick Snare Hats Toms1 Toms2 Toms3 OH Bass Elec Guit Ac Guit Keys L Keys R Guit Delay...

A

Studio	Mono	TYPES EXIT
2-Tap	Pong	
Modulated	Tape	
	Reverse	

Reverbs
Delays
Misc

lexicon TYPE PRE DLV 34ms MID RT 860ms SIZE 14m SHAPE 29 SPREAD 24 RT HC 10.0 HI CUT 8.00 B BOOST 1.00kHz RATIO 3 DIFF 87 ER TIME 34ms ER LEVEL +89 MIX WET 98

LEX3 Small Hall

Kick Snare Hats Toms1 Toms2 Toms3 OH Bass Elec Guit Ac Guit Keys L Keys R Guit Delay...

A

Chorus	Rotary	Pitch Shift	TYPES EXIT
Flanger		Detune	
Phaser			
Tremolo			
Vibrato			

Reverbs
Delays
Misc

lexicon TYPE PRE DLV 34ms MID RT 860ms SIZE 14m SHAPE 29 SPREAD 24 RT HC 10.0 HI CUT 8.00 B BOOST 1.00kHz RATIO 3 DIFF 87 ER TIME 34ms ER LEVEL +89 MIX WET 98

LEX3 Small Hall

Kick Snare Hats Toms1 Toms2 Toms3 OH Bass Elec Guit Ac Guit Keys L Keys R Guit Delay...

FX DESCRIPTIONS

The Vi Series Lexicon FX are divided into three categories: REVERBS, DELAYS and MISC.

REVERBS

Reverberation (or “reverb” for short) is the complex effect created by the way we perceive sound in an enclosed space. When sound waves encounter an object or boundary, they don’t just stop. Some of the sound is absorbed by the object, but most of the sound is reflected or is diffused. In an enclosed space, reverb is dependent on many features of that space, including the size, shape and the type of materials that line the walls. Even with closed eyes, a listener can easily tell the difference between a cupboard, a locker room and a large auditorium. Reverb is a natural component of the acoustic experience, and most people feel that something is missing without it.

Hall Reverbs - Stereo

SMALL HALL, LARGE HALL, DRUM HALL, VOCAL HALL.

A **Hall** reverb is designed to emulate the acoustics of a concert hall – a space large enough to contain an orchestra and an audience. Because of the size and characteristics, Halls are the most natural-sounding reverbs, designed to remain “behind” the direct sound – adding ambience and space, but leaving the source unchanged. This effect has a relatively low initial echo density which builds up gradually over time. **Vocal Hall** and **Drum Hall** reverbs are specifically tailored for those uses. **Vocal Hall** has a lower overall diffusion which works well with program material that has softer initial transients like a voice. **Drum Hall** has a higher diffusion setting which is necessary to smooth out faster transient signals found in drums and percussion instruments.

In addition to general instrumental and vocal applications, the Hall program is a good choice for giving separate tracks in a mix the sense of belonging to the same performance.

Plate Reverbs - Stereo

SMALL PLATE, LARGE PLATE, DRUM PLATE, VOCAL PLATE.

A **Plate** reverb is a large, thin sheet of metal suspended upright under tension on springs. Transducers attached to the plate transmit a signal that makes the plate vibrate, causing sounds to appear to be occurring in a large, open space. The Plates in the Vi Series FX units model the sound of metal plates with high initial diffusion and a relatively bright, colored sound. **Plate** reverbs are designed to be heard as part of the music, mellowing and thickening the initial sound. **Plate** reverbs are often used to enhance popular music, particularly percussion.

Chamber Reverb - Stereo

Historically, recording studio chambers were oddly shaped rooms with a loudspeaker and set of microphones to collect ambience in various parts of the room. **Chamber** programs produce even, relatively dimensionless reverberation with little color change as sound decays. The initial diffusion is similar to the **Hall** programs. However, the sense of size and space is much less obvious. This characteristic, coupled with the low color of the decay tail, makes these programs useful on a wide range of material - especially the spoken voice, to which **Chamber** programs add a noticeable increase in loudness with low colour.

Room Reverb - Stereo

Room produces an excellent simulation of a very small room which is useful for dialogue and speech applications. **Room** is also practical when used judiciously for fattening up high energy signals like electric guitar amp recordings.

Ambience Reverb - Stereo

Ambience is used to simulate the effect of a small or medium sized room without noticeable decay. It is often used for voice, guitar or percussion.

Gated Reverb - Mono In/Stereo Out

Gated reverb is created by feeding a reverb, such as a metal plate, through a gate device. Decay Time is set to instant, while Hold Time varies duration and sound. The **Gated** reverb provides a fairly constant sound with no decay until the reverb is cut off abruptly. This program works well on percussion - particularly on snare and toms.

Reverse Reverb - Mono In/Stereo Out

Reverse reverb works in the opposite fashion from normal reverb. Whereas a normal reverb has the loudest series of reflections heard first that then become quieter over time, the **Reverse** reverb has the softest reflections (essentially the tail of the reverb) heard first, and then grows louder over time until they abruptly cut off.

Spring Reverb - Mono In/Stereo Out

A **Spring** reverb is created by a pair of piezoelectric crystals—one acting as a speaker and the other acting as a microphone—connected by a simple set of springs. The characteristic ‘boing’ of a spring is an important component of many classic rock and rockabilly guitar sounds.

Reverb Controls

Pre Delay

Creates an additional time delay between the source signal and the onset of reverberation. This control is not intended to precisely mimic the time delays in natural spaces, as the build-up of reverberation is gradual, and the initial time gap is usually relatively short. For the most natural effect, the **Pre Delay** values should be set in the range of 10-25 milliseconds. However, if a mix is very busy or overly cluttered, increasing the **Pre Delay** time may help clarify it, and set each instrument apart from each other.

Mid RT

Controls the amount of time the reverb can be heard. Higher settings increase reverberation times which are usually associated with larger acoustical environments, but can decrease intelligibility. Lower settings shorten reverb times and should be used when a smaller apparent space or a more subtle effect is desired.

Size

Size sets the build-up rate of diffusion after the initial period (which is controlled by Diffusion). The Size control changes reverb sound from very large to very small. Generally, set this control to the approximate size of the acoustic space being created, before adjusting anything else. The size in meters is roughly equal to the longest dimension of the space. Audio is temporarily muted when Size is changed.

Diffusion

Controls the initial echo density. High settings of Diffusion result in high initial echo density, and low settings cause low initial density. In a real-world situation, irregular walls cause high diffusion, while large flat walls cause low diffusion. For drums and percussion, try using higher Diffusion settings.

Shape & Spread

In the Hall reverbs, Shape and Spread work together to control the overall ambience of the reverberation. Shape determines the contour of the reverberation envelope. With Shape all the way down, reverberation builds explosively, and decays quickly. As Shape is advanced, reverberation builds up more slowly and sustains for the time set by Spread. With Shape in the middle, the build-up and sustain of the reverberation envelope emulates a large concert hall (assuming that Spread is at least halfway up, and that Size is 30 meters or larger). Low Spread settings result in a rapid onset of reverberation at the beginning of the envelope, with little or no sustain. Higher settings spread out both the buildup and sustain.

RT High Cut

Rt HC sets the frequency above which a 6dB/octave low-pass filter attenuates the reverberated signal. It does not attenuate the reflections. High frequencies are often rolled off with this parameter, resulting in more natural-sounding reverberation. Setting a low frequency for this parameter can actually shorten the reverb time, as it damps the audio as it recirculates.

Hi Cut

Adjusts the amount of high frequency content in the reverberation tails. Higher frequency settings increase high frequency response, creating brighter reverbs; lower frequency settings create darker reverbs with more bass frequency emphasis.

Bass Boost Frequency

Sets the frequency at which the transition from Mid Rt to Low Rt takes place. This control should be set at least two octaves higher than the low frequency you want to boost.

For example, to boost a signal at 100Hz, set Bass Boost Frequency to 400Hz. (This setting works well for classical music.) Crossover works best around 400Hz for boosting low frequencies, and around 1.5 kHz for cutting low frequencies.

Bass Boost Ratio

Bass Boost boosts or cuts frequencies below Bass Boost Frequency. The amount of boost or cut required is highly dependent on the material being processed.

ER Time

Adjusts the amount of time before reverb early reflections occur.

ER Level

Adjusts the level of early reflections within the reverb.

Feedback Delay

Changing this parameter changes the resonant frequencies of **Plate** reverb.

Feedback Level

Adjusts the **Plate** reverb's presence and prominence.

Boing

This is a unique parameter to the **Spring** reverb, designed to increase or decrease the amount of spring rattle that is a physical characteristic of spring tank reverbs.

DELAYS

Delays repeat a sound a short time after it first occurs. Delay becomes echo when the output is fed back into the input (feedback). This turns a single repeat into a series of repeats, each a little softer than the last.

Studio Delay - Stereo

The **Studio Delay** features up to 1 second of stereo delay and offers a built-in ducker that attenuates the delay output whenever signal is present at the input. This can be used to keep the original signal from being muddled up by delay repeats.

2-Tap Delay - Stereo

The **2-Tap Delay** is probably best described as an adjustable pong delay where each tap can be individually set in relation to the delay time. The 2 taps are a calculated percentage of the actual delay time from 1-100% (for example, if the delay time is 500ms and Tap 1 is set to 50% and Tap 2 is set to 100%, Tap 1 time would be 250ms and Tap 2 time would be 500ms). Narrow spacing of the tap percentages can widen the stereo image of the delay while wider tap spacing can create rhythmic delay lines.

Modulated Delay - Stereo

The **Modulated Delay** is enhanced by an LFO (low frequency oscillator) that produces a chorusing effect on the delay repeats. This is a great delay for guitar and instrument passages that need that “special something.”

Mono Delay - Mono In/Stereo Out

The **Mono Delay** is the cleanest, most accurate of the delay programs, with up to 1 second of mono delay with panned output, and the built-in ducking feature.

Pong Delay - Mono In/Stereo Out

This delay effect pans the delay repeats from left to right, while the input signal remains at its original (center) position.

Tape Delay - Mono In/Stereo Out

In the days before digital, delays were created using a special tape recorder in which the magnetic recording tape was looped, with closely-spaced recording and playback heads. The delay effect was created by the tape moving in the space between the record and playback heads – while delay time was adjusted by changing the speed of the tape loop. Although very musical-sounding, wow and flutter combined with a significant loss of high frequencies, and to some extent also low frequencies, are all elements commonly associated with tape recordings.

Reverse Delay - Mono In/Stereo Out

This delay effect emulates the old studio trick of flipping a tape over, playing it backwards through a tape delay, and recording the effect. The delays “build up” from softer to louder – creating the sensation that the delays come before the signal.

Delay Controls

Tempo

The actual delay time, as tapped in by the **Tempo** button. This time is expressed as tempo in BPM (beats per minute). Tempo works in conjunction with Delay Time to set the actual delay time that is heard.

Delay Time

Controls the length of the delay time relative to Tempo. At the middle of its range, delay repeats are synchronous with the **Tempo** button; lower values create faster repeats, while higher values increase the time between repeats.

Feedback

Controls the number of delay repeats by feeding the delay output signal back into the delay input. This creates a series of delay repeats, each slightly attenuated until they become inaudible. Higher settings create more repeats; lower settings reduce the number of repeats. When this knob is turned fully clockwise, it engages Repeat Hold – delay repeats play back in an infinite loop, but no further input signal is introduced into the delay effect. Repeat Hold is available only on **Studio, Mono** and **Pong Delay**.

Lo Cut Filter

Frequencies below this level are attenuated.

Hi Cut Filter

Frequencies above this level are attenuated.

Ducker Threshold

The **Studio, Mono** and **Pong** delays offer a “ducking” feature, which causes the delay repeats to be attenuated by a variable amount (between 0 and 18dB) when an input signal is present. As the performance pauses, the delay signal level returns to its normal setting. This allows the delay to remain as an effect, but not clash with the original signal. For example whilst a vocalist is singing, the level of delay is kept down, but in the pauses the level of the repeats is brought up to provide a smooth tail to the vocal phrases. The Ducker Threshold sets the level at which the input signal has to be at for ducking to cut in – the higher the threshold, the louder the signal has to be for ducking to occur.

Ducker Level

Ducker Level sets the amount of attenuation once the signal has exceeded the threshold. 0dB is no ducking, 18dB is the maximum amount of ducking to the delayed signal.

Smear

Available only for **Tape** and **Reverse Delays**, this parameter controls the amount of “smear,” or signal degradation and frequency loss. The higher the setting, the more each delay repeat loses intelligibility compared to the original signal.

Level 1 & 2

Adjusts the output level of Tap 1 and Tap 2.

Pan 1 & 2

Adjusts the pan position in the stereo field of Tap 1 and Tap 2.

Mod Depth

This controls the intensity of modulation, or “depth” in the **Modulated Delay**. Lower settings produce a more subtle chorus effect, while higher values give a more lush chorusing of the delay repeats.

MISC EFFECTS

The MISC category provides primarily modulated and pitch-varying effects.

Chorus - Stereo

Chorus creates a lush, full sound by combining two or more signals together where one is unaffected and the other signals vary in pitch very slightly over time. **Chorus** is commonly used to fatten up tracks and to add body to guitars without coloring the original tone. **Chorus** can also be used with discretion to thicken a vocal track.

Flanger - Stereo

This effect was originally created by simultaneously recording and playing back two identical programs on two tape recorders, then using hand pressure against the flange of the tape reels to slow down first one machine, then the other. The result was a series of changing phase cancellations and reinforcements, with characteristic swishing, tunneling, and fading sounds.

Phaser - Stereo

The **Phaser** automatically moves frequency notches up and down the spectrum of the signal by means of a low frequency oscillator (LFO), creating an oscillating “comb filter” type effect. This effect is very useful on keyboards (especially pad presets) and guitars.

Tremolo/Pan - Stereo (Wet Only)

Tremolo/Pan creates rhythmic changes in signal amplitude. **Tremolo** is obtained by setting Phase to 0 degrees, and affects both channels' amplitude simultaneously.

If the Phase is set to 180 degrees, an **AutoPanner** effect is generated, with the amplitude of one channel being raised whilst that of the other channel is lowered. Speed settings below 1Hz are recommended in this case.

Vibrato - Stereo (Wet Only)

Vibrato is obtained by smoothly varying the pitch of the signal just sharp and flat of the original at a determined rate. Phase controls whether the pitch of both channels is modulated together, or in an opposite direction.

Rotary - Mono In/Stereo Out (Wet Only)

Rotary speaker cabinets were designed to provide a majestic vibrato/choir effect for electronic theater and church organs. The most well known rotary speaker is the Leslie™ Model 122, which has two counter-rotating elements: a high-frequency horn and a low-frequency rotor with slow and fast speeds. The sound generated as the spinning elements change speed is truly magical. The swirling, spacious effect is difficult to describe – but clearly recognizable.

The **Rotary** effect is modeled after a Leslie-style cabinet. The input signal is split into high and low-frequency bands. The rotation effect is created by a synchronized combination of pitch shifting, tremolo, and panning. Like the physical cabinet, the high (horn) and low (rotor) frequencies are “spun” in opposite directions. Horn and rotor speeds are independent, and designed with acceleration and deceleration characteristics to simulate the inertia of the original mechanical elements.

A virtual necessity for organ music, **Rotary** also sounds remarkable with guitar and electric piano rhythm parts. In fact, this program is a great alternative to the **Chorus** and **Tremolo** effects for any sound source.

Pitch Shift - Stereo

This effect shifts the frequency spectrum of the input signal. Altering the pitch of a sound produces a wide range effects - from subtle detunes to full interval shifts up or down a two octave range. The **Pitch Shift** effect is a chromatic shifter, meaning all notes of the scale are shifted by the same interval. **Pitch Shift** is very useful with guitar tracks, monophonic synth lines, or where special vocal effects are needed.

Detune - Stereo

Detune adds a slightly pitch-shifted version of the original source, thickening the sound. This creates a particularly effective simulation of “double-tracking.” This effect is also a great alternative to the **Chorus** effect, adding the richness of a chorus without the audible sweep caused by the chorus rate. It is also useful for creating a wide stereo signal from a mono source, by setting a small detune amount up on one output and down on the other, and panning the two outputs hard left and right.

MODULATED EFFECT CONTROLS

Speed

Sets the speed at which the modulated effect cycles.

Depth

Scales the intensity of the effect. This control affects the output of the LFO only. It has no effect on the outputs of the individual waveforms.

Voices

Controls the number of additional Chorus voices.

Regen

Controls the amount of modulated signal being fed back into the input, creating feedback. Higher amounts add more resonance to the signal.

Diffusion

Creates a time-smoothing effect similar to diffusion in reverb. Diffusion can be a subtle effect to add a little warmth to the chorus.

PreDelay

Determines the amount of offset between the two signals that create the flange effect. Lower values create a tighter effect, higher values result in a more extreme “whooshing” sound.

Waveform

Selects the wave pattern used by the modulated effect.

Phase

Controls whether amplitude or depth change occurs in both left and right outputs simultaneously or alternates between left and right outputs.

Phase Stages

Selects between a 4, 8, or 12 state phase shifter.

Stereo Spread

Increases or decreases the stereo imaging of the Rotary effect.

Drive

Provides overdrive gain to the preamp section of the rotary speaker effect.

Minimum Speed

Sets the minimum speed at which the effect will oscillate.

Maximum Speed

Sets the maximum speed at which the effect will oscillate.

Doppler

Increases or decreases the Doppler pitch effect that is created by the physics of a rotating speaker.

Shift 1 & 2

Determines the amount of pitch shift or detune shift from the original signal source. Works best with individual notes.

Delay 1 & 2

Sets the delay time before the pitch shift or detune effect is heard in the Pitch Shift and Detune effects.

Feedback 1 & 2

Adjusts how much of the shifted signal is sent back through the delay line in Pitch Shift and Detune for creating cascading arpeggio type effects.

Pan 1 & 2

Sets the pan position in the stereo field for each tap in the 2-Tap Delay.

BSS® Graphic Equalisers

The Vi1 uses a total of 27 high-quality BSS® Graphic Equalisers (GEQ).

Each of the 24 Busses and the three Main Masters are equipped with a 30-band Graphic Equalizer modelled on the FCS-960 from BSS®.

To access any of the GEQs first press the [BUSSES 1-16] or [BUSSES 17-24] key.

A touch on the <GEQ Field> opens the GEQ Page and changes the Fader Glow colour of the 8 output section faders to red.

The 8 output section faders are labelled with the GEQ Frequencies, and control the Gain of the individual bands. The range of control is +/- 12dB.



Hint: when a fader is moved away from its default 0dB position, the [ON] key above the fader glows red. Pressing a red [ON] key will reset the fader to the 0dB position.



Alternatively, solo an output bus in the Control Bay. This brings up the Output Channel Strip on the upper left quadrant of the screen. Touch the <GEQ> field of the Output Channel to access the GEQ on the faders, as described above.

When a <GEQ Field> is touched, the master bay's screen appears as shown here.

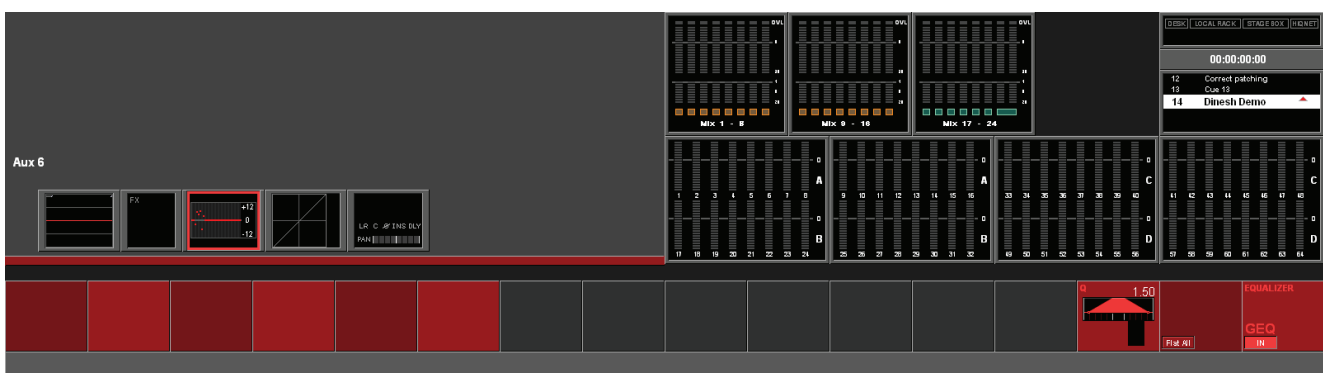

There are two controls available on this screen:

FLAT ALL

{FLAT ALL} set the Gains of all 30 bands to 0 dB

GEQ {IN}

GEQ {IN} switches the GEQ on. The colour of the graph in the <GEQ Field> of the output in question changes to red when it is switched on.

Accessing the 30 GEQ bands on the 8 output section faders

The GEQ is assigned only to the 8 faders in the Control Bay of the surface, leaving all input faders free to control Input Channels.

In order to access the 30 bands of the GEQ in Small Mode, it is necessary to scroll through the frequency bands in pages of 8 bands at a time.

This paging is controlled by the Output Fader Page buttons, located in the Control Bay of the console, which operate in a different mode during activation of Small GEQ: (Note it is not possible to switch Output Fader Pages whilst Small GEQ is active)

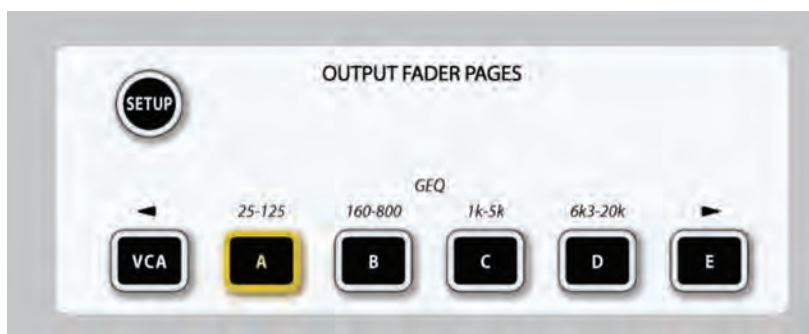

The Output Fader page buttons have the following functions in Small GEQ mode:

VCA: Scrolls the page by 4 bands to the left, repeats with further presses

A: selects 25 - 125Hz range

B: selects 160 - 800Hz range

C: selects 1kHz - 5kHz range

D: selects 6.3kHz - 20kHz range

E: Scrolls the page by 4 bands to the right, repeats with further presses

The VCA and E buttons are useful for adjusting or viewing a part of the GEQ curve that falls between two frequency pages – they effectively move the view by half a page (4 bands) with each press. Two adjacent page buttons illuminate when the displayed frequency page is ‘half way between’ two of the fixed pages.

Main Menu – MIDI page open & RX Channel list selected

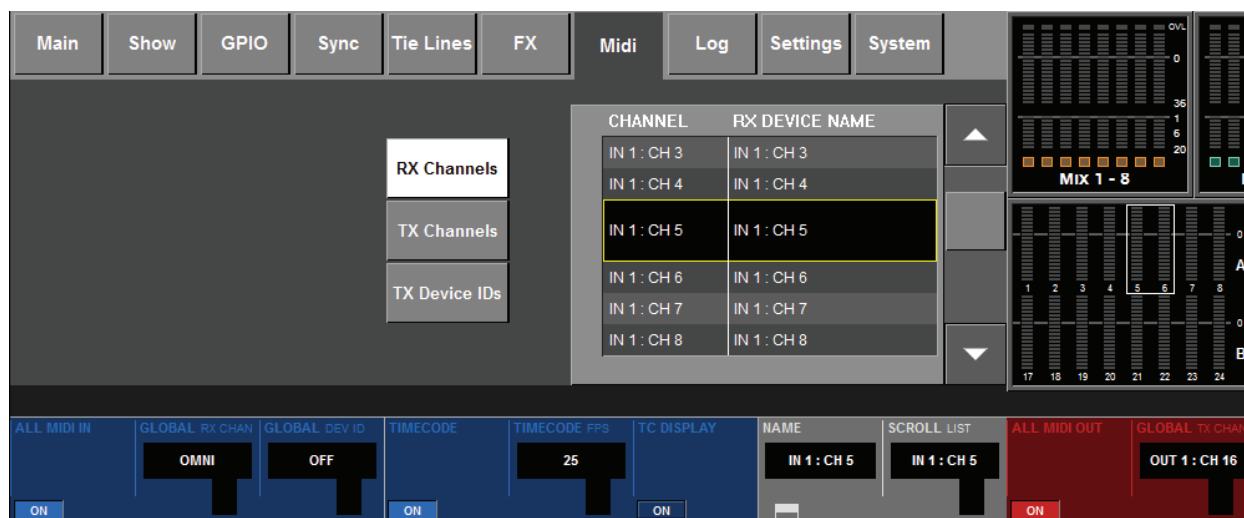

The MIDI page of the Main Menu contains the following elements :

- Device Lists for TX MIDI Channel, RX MIDI Channel and TX MIDI Device ID.
- Global MIDI Receive Channel, On/Off and Global Receive MIDI Device ID
- Global MIDI Transmit Channel and On/Off switch.
- MIDI Timecode RX global On/Off switch and Frame Rate control.
- Display Timecode On/Off.

DEVICE LISTS

The Device Lists are mapping tables that display all available MIDI channels (16 for RX, 16 for TX), and allows a user-defined name to be entered for each channel, corresponding to the connected device. There is also a third table that allows 128 Device IDs (similar to MIDI channels but for MMC and MSC messages) to be mapped to names.

Since each attached device is allocated its own MIDI channel or Device ID, this allows the user to see the actual device name in the Cue List EDIT MIDI page, making the selection of the required device easier.

By default the Device Name fields are populated with the same text as in the MIDI Channel fields, ie 'Channel 1' - 'Channel 16' (for RX).
'Channel 1 OUT1 - Channel 16 OUT1'

The settings of the Device names are stored with the Show and are global for the console (not individual per-Cue).

The **<RX CHANNELS>**, **<TX CHANNELS>** and **<TX DEVICE ID>** buttons select one of the three Device Lists for viewing and name editing.

The **NAME** sub-page button opens the QWERTY keyboard and allows the default Device names to be edited.

The **SCROLL LIST** encoder allows fast scrolling of the selected list.

The List wraps around when scrolled – ie it is possible to scroll down from Chan 1 to Chan 16, and up

from Chan 16 to Chan 1 in the case of RX, (or from OUT1:1 to OUT1:16 in the case of TX). This is of particular value in the case of the Device ID list, which has a values range from 0 to 127 (127 is displayed as ALL and cannot have its name edited).

Global VST encoders

These encoders are not related to the above Channel Lists. They are located immediately below the lists in order to keep the space on the left clear for future additions.

MIDI IN: The blue area of the screen controls parameters relating to MIDI input.

ON button: works as a global enable buttons for the MIDI IN – when this button is off, no reception is possible from the MIDI IN.

GLOBAL RX CHAN VST encoder:

Sets the Global Receive MIDI Channel for the console. This channel can be referenced by the Cue List MIDI RX Channel parameter.

The Global receive channel may also be used in the future for functionality where the console needs to receive MIDI messages that are not associated with the Cue List triggering.

The value set here can nevertheless be selected from within the Cue List MIDI page as one of the available receive channels.

Values range : Off, 1-16, Omni. (Omni mode means receiving on all channels).

Default value: Omni

GLOBAL RX DEVICE ID VST encoder : Sets the Global Receive MID Device ID for the console.

This Device ID can be selected in the Cue List MIDI In page as one of the Device IDs for the MSC 'Goto Cue' trigger messages.

This may also be used in the future to allow a Device ID to be set for the console in case MMC or MSC commands need to be received by the console in future functionality which is not associated with triggering Cues.

Values range : Off, 0-127.

Default value : 127

GLOBAL TIMECODE On/Off VST encoder: Enables or disables the reception of MIDI Timecode. The MIDI Timecode can be set as a trigger for Cues, but if this parameter is set to Off, it will not be possible to recall any Cues with MTC, even if the individual Timecode On/Off switches in each Cue are set to On.

GLOBAL TIMECODE FRAME RATE VST encoder: Allows the frame rate for the internally set values for transmitted and received MIDI Timecode to be set. The frame rate of the incoming timecode timecode for cue triggering is automatically detected.

The frame rate parameter only affects the Frames parameter values range of any Timecode entry fields on the desk (ie: EDIT Cue Number field touched, and EDIT MIDI field touched and a MMC Locate TX event set up).

Values range : discrete values of 24, 25, 30 fps.

Default value : 25

TC Display {ON} key. When switched on, the incoming MIDI timecode value and its automatically detected frame rate is displayed instead of the show name on the main page in the control bay screen.

MIDI OUT: The red area of the screen controls parameters relating to MIDI output.

ON button: works as a global enable buttons for the MIDI OUT – when this button is off, no transmission is possible from the MIDI OUT.

GLOBAL TX CHAN VST Encoder :

Sets the Global Transmit MIDI Channel for the console.

This is not used currently but may be used for future functionality such as the transmission of MIDI messages from the faders and other desk controls.

Values Range : Off, Out1:1-16,

Default value: Off.

All parameters in the Menu\MIDI page are stored in the current Show!

Main Menu –MIDI page open & TX Channel list selected

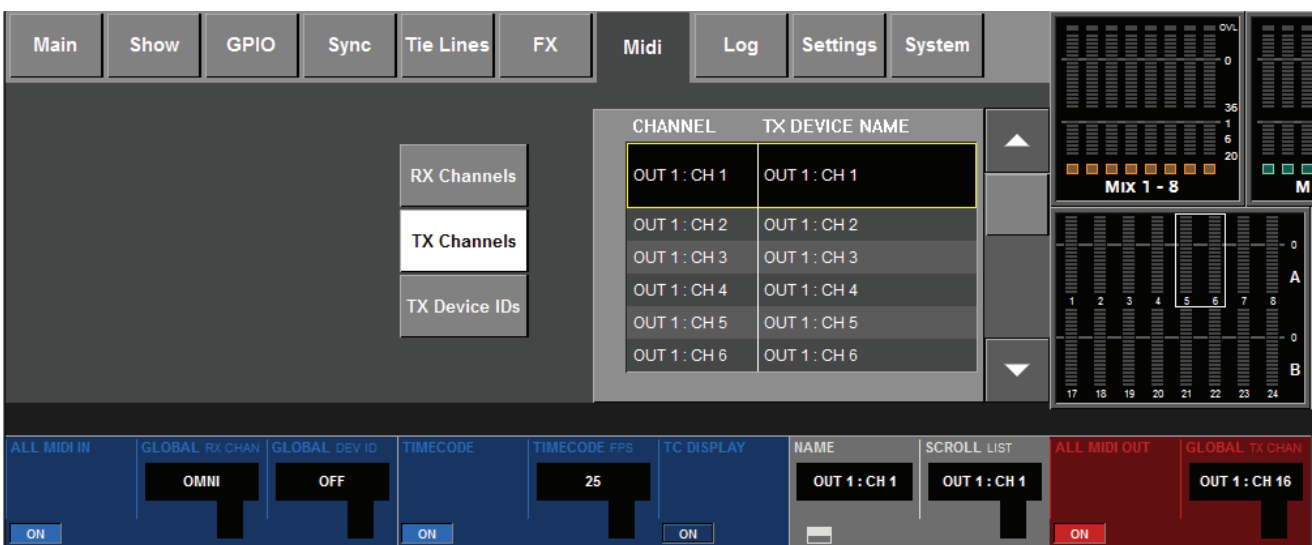

Showing the Device List with the **Transmit Channels** button selected.

The **NAME** sub-page button opens the QWERTY keyboard and allows the default Device names to be edited.

The unedited names have the format:

OUT1: Channel 1

OUT1: Channel 2

↓
v

OUT1: Channel 16

Main Menu -MIDI page open & Transmit Device IDs list selected

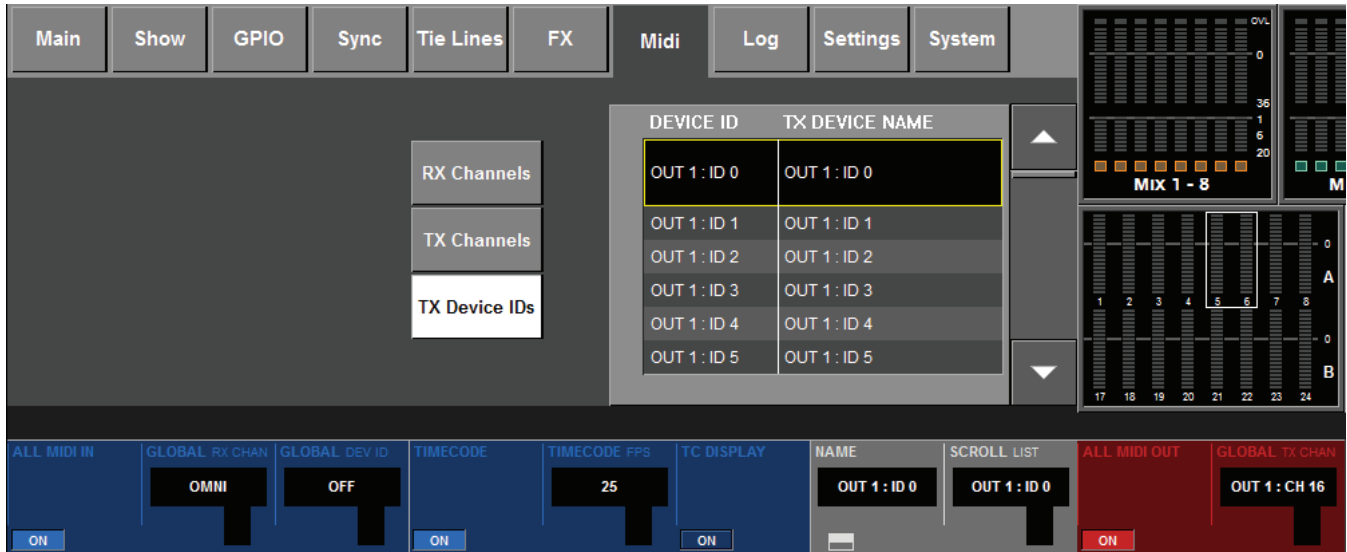

Showing the Device List with the **Transmit Device IDs** button selected.

The **NAME** sub-page button opens the QWERTY keyboard and allows the default Device names to be edited.

Device ID 127

With MIDI Device IDs, the number 127 is a special case that is reserved for transmitting to ALL connected devices. Therefore the Device name for the number 127 is fixed as 'ALL' and it is not possible for the User to edit it.

MIDI Event Types

Event Type	Display as:	Value 1, data range Value 2, data range	Cue List	
			TX	RX
Note On	Note On	Note value, 0-127	Yes	Yes
		Velocity 0-127	Yes	No
Program Change	Prog Chng	Program No., 0-127	Yes	Yes
		-		
Controller	Controller	Controller No., 0-127	Yes	Yes
		Value, 0-127		
SysEx String	SysEx	User-defined text string, transmitted as entered.	Yes	No
		-		
MIDI Show Control: GO TO CUE#	Go To Cue	Cue #, No. of cues in the cue list.	Yes	Yes
		-		
MIDI Machine Control (MMC): STOP,PLAY, FF, RW, EJECT, CHASE, PAUSE	MMC Stop MMC Play MMC Pause MMC FF MMC RW MMC Eject MMC Chase	DEVICE ID#, 0-127	Yes	No
		-		
MIDI Machine Control (MMC): LOCATE	MMC Loc	DEVICE ID#, 0-127	Yes	No
		Timecode value, Hrs:min:sec:frames		
MIDI Timecode (MTC)	MTC	Timecode value, Hrs:min:sec:frames	Yes	Yes
		-		

BLOCK DIAGRAM Soundcraft Vi1™

BLOCK DIAGRAM Soundcraft Vi1™

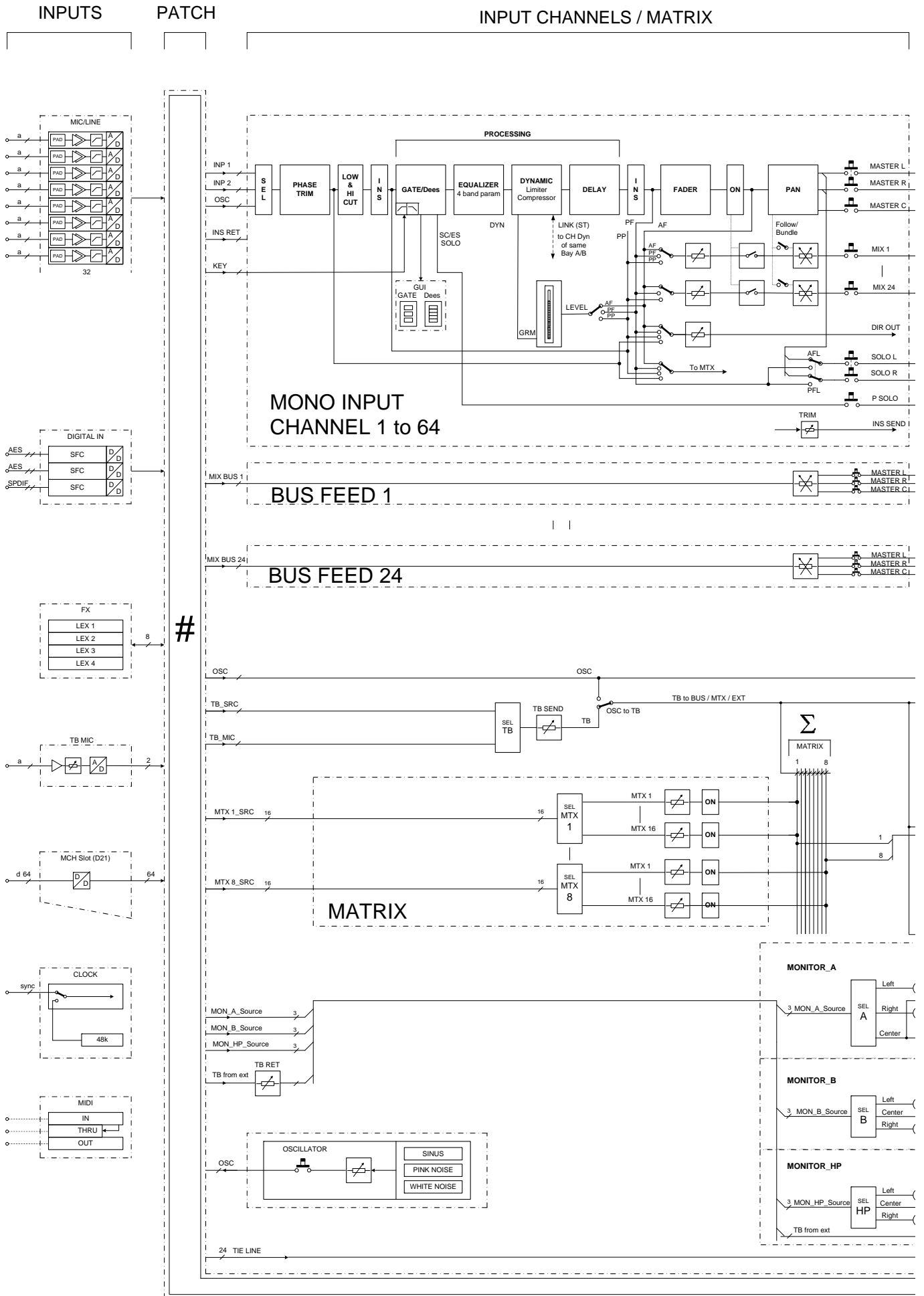



MASTER / MIX / MONITORING

PATCH

OUTPUTS

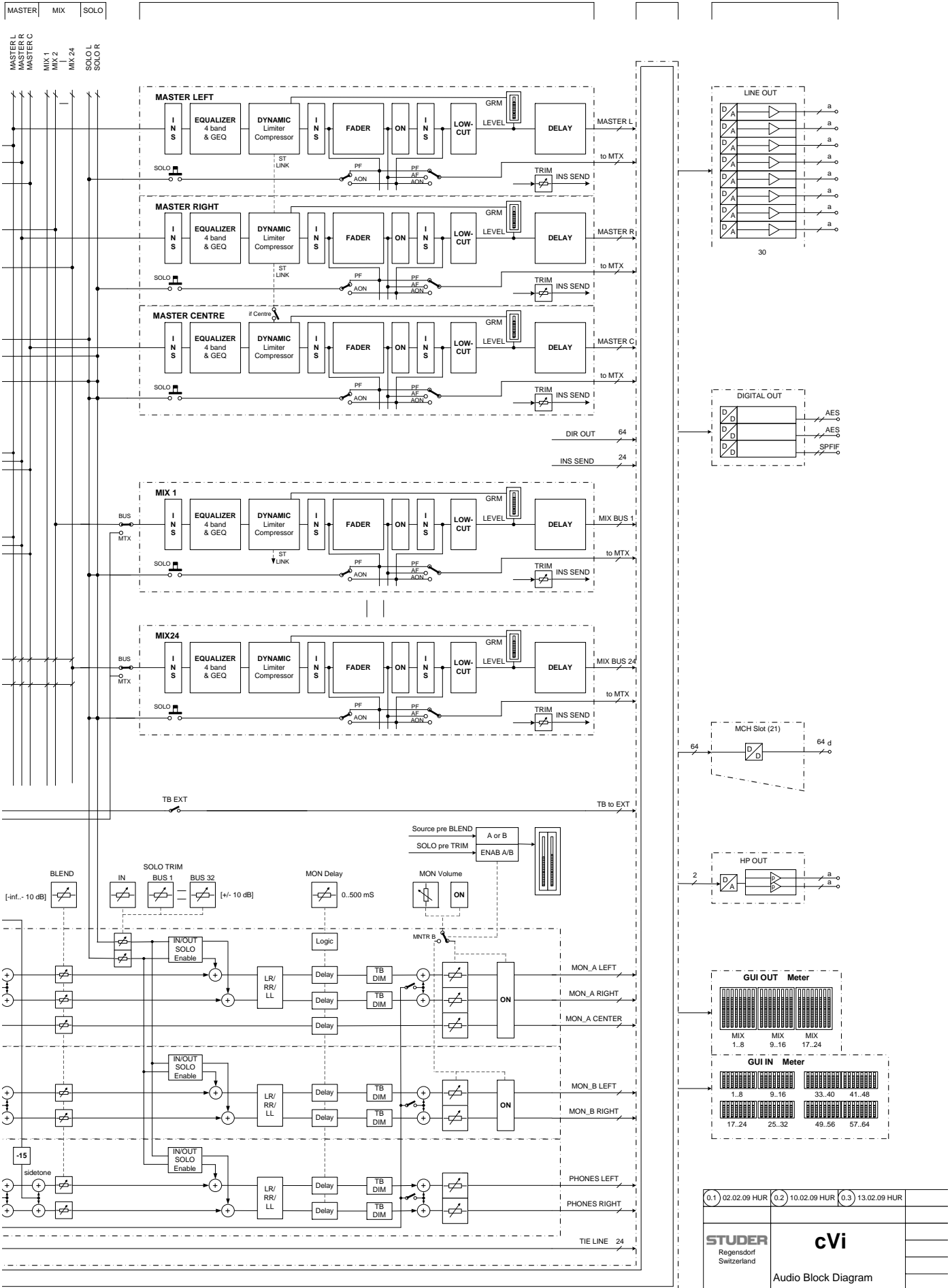

BLOCK DIAGRAM Soundcraft Vi1™

