

# R16

## Recorder:Interface:Controller

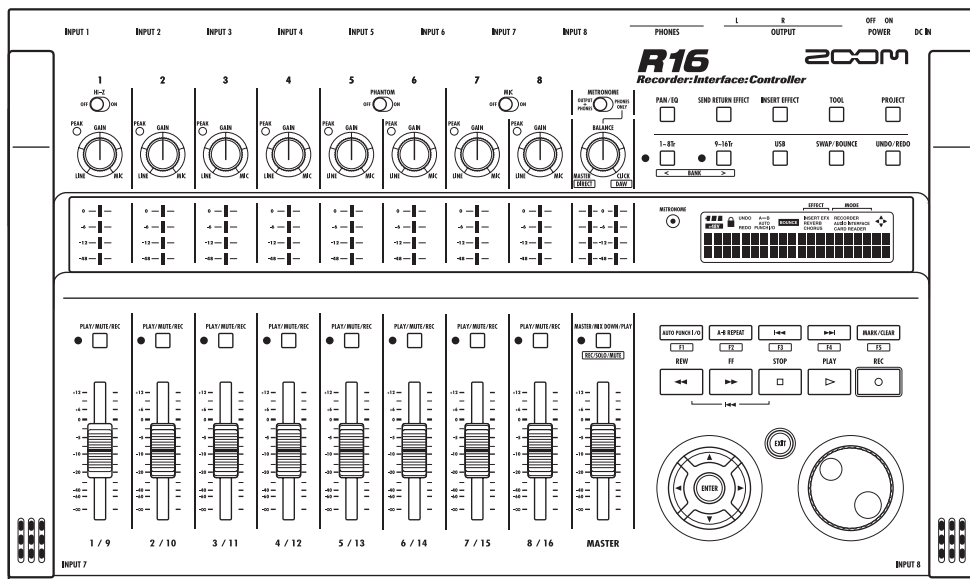

# OPERATION MANUAL



# Usage and safety precautions

## SAFETY PRECAUTIONS

In this manual, symbols are used to highlight warnings and cautions for you to read so that accidents can be prevented. The meanings of these symbols are as follows:



Warning

This symbol indicates explanations about extremely dangerous matters. If users ignore this symbol and handle the device the wrong way, serious injury or death could result.



Caution

This symbol indicates explanations about dangerous matters. If users ignore this symbol and handle the device the wrong way, bodily injury and damage to the equipment could result.

Please observe the following safety tips and precautions to ensure hazard-free use of the R16.

### Power requirements



Since power consumption of this unit is fairly high, we recommend the use of an AC adapter whenever possible. If you use batteries, use either alkaline or nickel-metal hydride batteries.

#### AC adapter operation

- Be sure to use only a DC5V/1A/center plus AC adapter (ZOOM AD-14). Use of an adapter other than that specified could damage the unit and pose a safety hazard.
- Connect the AC adapter only to an AC outlet that supplies the rated voltage required by the adapter.
- When disconnecting the AC adapter from the AC outlet, always grasp the adapter itself and do not pull on the cable.
- During lightning or when not using the unit for an extended period, disconnect the AC adapter from the AC outlet.

#### Battery operation

- Use six conventional size AA-1.5 volt batteries.
- The R16 cannot be used for recharging. Pay close attention to the labeling of the batteries to make sure you choose the correct ones.
- When not using the unit for an extended period, remove the batteries from the unit.
- If battery leakage has occurred, wipe the battery compartment and the battery terminals carefully to remove all remnants of battery fluid.
- While using the unit, the battery compartment cover should be closed.

### About grounding



Depending on installation conditions, a slight electrical charge may be felt when touching a metal part of the R16. If you wish to avoid this, ground the unit by connecting the ground screw on the rear panel to a good external ground.

- To prevent the risk of accidents, never use any of the following for grounding:
  - Water pipes (risk of electric shock)
  - Gas pipe (risk of explosion)
  - Telephone wiring ground or lightning arrester (risk of lightning strike)

### Environment



Caution

Avoid using your R16 where it will be exposed to:

- Extreme temperature
- High humidity, moisture, or splashing water
- Excessive dust or sand
- Excessive vibration or shock

### Handling

Never place objects filled with liquids, such as vases, on the R16 since this can cause electric shock.

The R16 is a precision instrument. Do not exert undue pressure on the keys and other controls. Also take care not to drop the unit, and do not subject it to shock or excessive pressure.



Caution

### Connecting cables and input and output jacks

You should always turn off the power to the R16 and all other equipment before connecting or disconnecting any cables. Also make sure to disconnect all connection cables and the power cord before moving the R16.

### Alterations



Warning

Never open the R16 case or attempt to modify the product in any way since this can result in damage to the unit.

### Volume



Warning

Do not use the R16 at a loud volume for a long time since this could cause hearing impairment.

## Usage Precautions

### Electrical interference

For safety considerations, the R16 has been designed to provide maximum protection against the emission of electromagnetic radiation from inside the device, and protection from external interference. However, equipment that is very susceptible to interference or that emits powerful electromagnetic waves should not be placed near the R16, as the possibility of interference cannot be ruled out entirely.

With any type of digital control device, the R16 included, electromagnetic interference could cause malfunction and could corrupt or destroy data. Care should be taken to minimize the risk of damage.

### Cleaning

Use a soft, dry cloth to clean the R16. If necessary, slightly moisten the cloth. Do not use abrasive cleanser, wax, or solvents (such as paint thinner or cleaning alcohol), since these may dull the finish or damage the surface.

### Back up

The data on the R16 could be lost because of malfunction or incorrect operation. Back-up your data.

### Copyrights

Except for personal use, unauthorized recording from copyrighted sources (CDs, records, tapes, video clips, broadcast material and so on) is prohibited.

ZOOM Corporation does not bear any liability for injunctions regarding copyright law infringement.

- © The SD symbol and SDHC symbol are trademarks.
- © Windows®/Windows Vista® are trademarks or registered trademarks of Microsoft®.
- © Macintosh® and Mac OS® are trademarks or registered trademarks of Apple Inc.
- © Steinberg and Cubase are trademarks or registered trademarks of Steinberg Media Technologies GmbH Inc.
- © Intel® and Pentium® are trademarks or registered trademarks of Intel® Corporation.
- © AMD Athlon™ is a trademark or registered trademark of Advanced Micro Devices, Inc.
- © All other trademarks, product names, and company names mentioned in this documentation are the property of their respective owners. All trademarks and registered trademarks mentioned in this manual are for identification purposes only and are not intended to infringe on the copyrighted properties of their respective owners.



# Introduction

Thank you very much for purchasing the ZOOM R16 Recorder/Interface/Controller. In this manual, we will call it the R16. The R16 has the following features.

## ■ Multitrack recorder that can use up to 32 GB SDHC cards

The R16 can record up to 8 tracks simultaneously. For example, recording a full band on individual tracks or multiple microphones placed around a drum kit. After making linear PCM recordings (WAV type) at 16/24-bit and 44.1-kHz sampling rate, you can transfer the recorded files to your computer to make use of them in your DAW software. You can even connect two R16s together with a USB cable, allowing you to record a maximum of 16 tracks.

## ■ Hi-Speed USB (USB 2.0) audio interface

You can use the R16 as a Hi-speed USB (USB 2.0) audio interface that has abundant input and output jacks. The R16 can handle 8 inputs and 2 outputs at a maximum of 24-bit and 96 kHz, and its effects can even be used at 44.1 kHz sampling rate. The unit can also operate using only USB bus power.

## ■ Usable as a control surface for DAW software

The R16 is equipped with functions that enable you to control DAW software in a computer via a USB cable. You can operate the transport of the DAW software, such as play, record and stop, and you can physically control fader operations. You can also assign various DAW functions to the R16's F1–F5 function keys. (The assignable functions depend on the DAW software.)

## ■ Various effects

The R16 has 2 main built-in effects—an insert effect that can be applied to specific channel signals and a send-return effect that can be used like the send-return bus of a mixer. You can use these effect in a wide variety of ways, including during recording, by applying them to already recorded tracks, and in mastering operations like mixing down and bouncing.

## ■ Handles various input sources including guitars, microphones and line-level equipment

The R16 is equipped with 8 input jacks that accept both XLR and phone connectors, including one that can handle high impedance signals and two that can supply 48V phantom power. The R16 can handle high impedance guitars and basses, dynamic and condenser microphones, and various line level instruments like synthesizers. It also has two built-in high performance microphones that are very convenient for recording acoustic guitar and vocals.

## ■ Comprehensive built-in mixer features

The R16 is equipped with a digital mixer that allows you to mix the playback of recorded and imported audio tracks. You can adjust the volume, pan, EQ and effects for each track and mix them into a stereo output.

## ■ Multiple tuner modes and a metronome for guide rhythms

The R16 not only has a standard chromatic tuning function, it also has functions for unusual tunings, including 7-string guitars and 5-string basses. The metronome can be used as a guide rhythm while recording. You can play the metronome sound through the mixer OUTPUT jacks or you can send it only through the headphones if you want. For example, in a live situation you could send the click just to the drummer via the headphone output.

## ■ Exchange files with computers and USB memory devices

The R16 has a USB 2.0 jack that allows high speed data transfer. You can transfer WAV audio files recorded on the R16 to a computer just by dragging and dropping. You can also exchange files with a connected USB memory device without using a computer.

Please read through this manual carefully in order to understand the R16 functions effectively.

After reading it, please keep the manual along with the warranty in a safe place.

\*Specifications are subject to change for improvement without notice.

# R16 operation flow

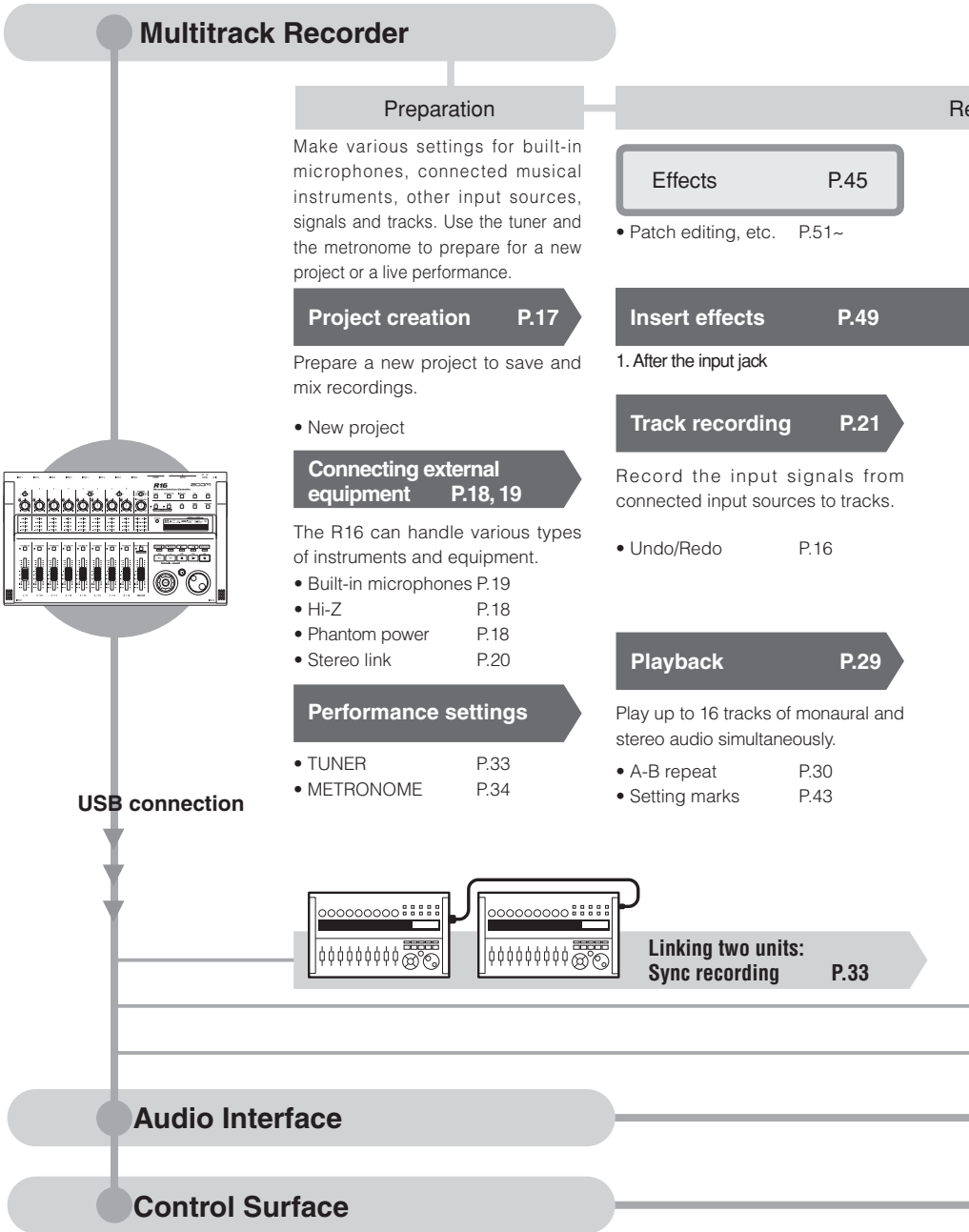

Record 8 tracks of mono and stereo audio simultaneously.  
Select up to 330 effects.

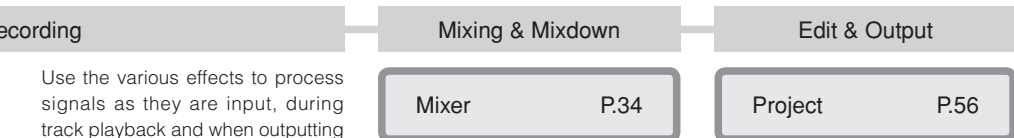

Use the various effects to process signals as they are input, during track playback and when outputting a mix.

**Mixer P.34**

Adjust the recorded track using the track mixer.

**Project P.56**

Recorded music files and settings for a song can be managed and stored as a project and then edited in various ways.

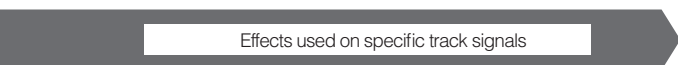

2. On mixer tracks as desired

3. Before the master fader

**Overdubbing P.25**

Record new tracks while playing back previously recorded tracks.

- Track assignment P.23

**Send/return effect**

There are two internal send/return effects in the built-in mixer—a chorus/delay effect and a reverb effect. Adjust the send levels of both effects separately for each mixer track.

**Starting over**

Pick and re-record just part of a file.

- Punch in/out P.27

**Mixing P.34**

Adjust parameters for each track.

- EQ • Volume • Pan P.37

**Mixdown**

Combine multiple tracks into one stereo pair.

- Bounce P.39
- Record on the master track P.42

- PROJECT/FILE P.56
- INFORMATION P.59
- IMPORT P.64
- DIVIDE P.63
- COPY P.60
- DELETE P.62
- RENAME P.61
- PROTECT P.56

**SD cards P.71**

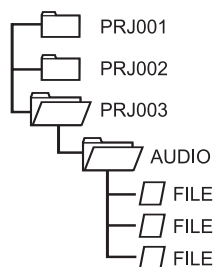

**SD card reader P.73**  
**USB memory P.73**

Exchange signals between DAW software and audio equipment

**P.77 (PDF version)**

Operate DAW software with the R16

**P.77 (PDF version)**

# Basic recording guide

Let's make a quick recording with the R16!

Here we explain how to record in stereo with the built-in microphones on the left and right side of the R16 and how to make a monaural recording of an electric guitar using the high impedance function.

## STEP 1 Insert an SD card and turn the power on.

## STEP 2 Create a new project.

1  Press and hold until you return to the main screen.

2  Press [PROJECT].

PROJECT  
>SELECT

Cursor keys

3 Select >NEW.

PROJECT  
>NEW [SD]003:22:52]



Press the right and left cursor keys to change the selection.

 Search the menu with the cursor and press [ENTER].

4 Name the new project.

PROJECT No. 003  
PRJ003

The new project number

The new project name

 Confirm the name and press [ENTER].

5 Select [CONTINUE].

SETTING?  
[CONTINUE] RESET



 Select the item with the cursor, and press [ENTER].

6 Execute.

No. 003:PRJ003  
Create?

 Confirm the creation of your new project and press [ENTER].

Return to the main screen.

PRJ 003  
000 00:00:00:000

This screen shows your new project name and number.

 Ref: Project

P.56

## STEP 3 Turn input source switches on.

Using the built-in microphones  
(Stereo recording)

1  Turn the [MIC] switch on for INPUT 7 & 8.

2 Press the status keys of INPUT 7 & 8 until their indicators light red.

 Press the [PLAY/MUTE/REC] key one or two times.  
When lit red, you can start recording.

or

To record an electric guitar  
(High impedance/monaural input)

1 Connect the guitar to INPUT 1.

2  Turn the [Hi-Z] switch on for INPUT 1.

3 Press the status key of INPUT 1 until the indicators lights red.

 Press the [PLAY/MUTE/REC] key one or two times.  
When lit red, you can start recording.

## NOTE

Hi-Z is only on INPUT 1, and the built-in stereo microphones function only on tracks 7 & 8. Tracks 7 & 8 correspond to INPUT 7 & 8 and are set up as 2 mono tracks by default. When you are using the built-in mics for a stereo recording, make a stereo link to create one stereo track.

 Ref: Stereo link

Instrument connection

P.20

P.19, 20

## STEP 4 Adjust the input sensitivity, monitoring level and output

### 1 Adjust the INPUT sensitivity with the [GAIN] knob.

You should adjust the [GAIN] of each INPUT so that the PEAK indicator blinks occasionally.

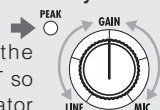

### 2 Adjust the recording level.

The red (0 dB) indicator of the level meter should not light when you apply an insert effect to an INPUT. You should adjust the PATCH LEVEL, for example, if necessary.

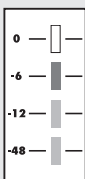

### 3 Adjust the monitoring level.

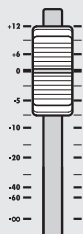

You can adjust the monitoring level of an instrument with the fader of the track it is being recorded on. (INPUT 1, for example, would be TRACK 1 or 9).

## NOTE

If the input signals distort during recording, adjust the input sensitivity or recording level, referring to Step 4.

After recording has completed, the "wait" bar will be displayed. Do not turn the power off or take the SD card out until the "wait" bar disappears. If you do not follow this procedure, you may damage the data or cause other problems.

☞ Ref: Recording methods in detail  
: How to use the INSERT EFFECT

P.17-

P.49

## STEP 5 Record—Complete—Play

### Record

#### 1 Move to the beginning.

Press [STOP] & [REW] at the same time.

PRJ 003 PRJ003  
00 00:00:00:000

#### 2 Start recording.

Press [REC] & [PLAY] at the same time.

PRJ 003 PRJ003  
00 00:00:10:152

The counter starts to run.

#### 4 Stop recording.

Press [STOP].

### Playback

#### 1 Exit record standby mode.

Press the STATUS KEY to turn the green light on.

When lit green, you can play the track.

When the light changes from red to green, the track status changes from "record standby" to "playback standby."

#### 2 Return to the top.

Press [STOP] & [REW] at the same time.

PRJ 003 PRJ003  
00 00:00:00:000

#### 3 Start playback.

Press the [PLAY] key.

PRJ 003 PRJ003  
00 00:00:10:152

#### 4 Stop playback.

Press the [STOP] key.

# Table of contents

---

Usage and safety precautions →P.1

Introduction →P.2

R16 operation flow →P.3

Basic recording guide →P.5

Names of parts →P.9

Connections →P.11

SD card insertion →P.12

Preparing the power →P.13

Turning the power on/off →P.14

Date & time setting →P.14

Switch and key operation →P.15

Display information →P.16

## Track recording

R16 recording flow →P.17

Creating a new project →P.17

Connecting instruments and  
making monaural settings →P.18

Instrument connections:  
stereo settings and status keys →P.19

Stereo link →P.20

Recording the first track →P.21

Track assignment →P.23

## Overdubbing

Recording additional tracks →P.25

## Punching in and out

Automatic punch-in/punch-out →P.27

Manual punch-in/punch-out →P.28

## Playback

Playback of a project →P.29

Repeat playback of a  
specific section (A-B repeat) →P.30

Using the counter and  
markers to move (locate) →P.31

## Tool

Tuner →P.33

Metronome →P.34

16-track synchronized recording →P.35

## Mixing

R16 mixing procedure flow →P.36

Track settings for EQ, pan  
and send-return level →P.37

Track parameters →P.38

## Mix down/Bounce

Combining multiple tracks to 1-2 tracks →P.39

Using a mastering effect →P.41

Recording to the master track →P.42

Entering names →P.43

Error list: what to do when these  
messages appear on the screen →P.44

## Effect

Effect patch overview →**P.45**

Input/output of the insert

and send return effects →**P.47**

Insert effect insertion position →**P.49**

Patch editing →**P.52**

Patch save →**P.53**

Patch import →**P.54**

Using the insert effect

only for monitoring →**P.55**

## Project

Project overview & project protection →**P.56**

Selecting projects and files →**P.58**

Project and file information →**P.59**

Copying projects and files →**P.60**

Renaming files and projects →**P.61**

Deleting files and projects →**P.62**

Dividing files →**P.63**

Import files from other projects →**P.64**

Sequential playback of projects →**P.65**

## System/SD card

Recording format bit rate setting →**P.67**

Adjusting the display →**P.68**

Changing the SD card

while the power is on →**P.69**

Formatting SD cards and

verifying card capacities →**P.70**

Confirming the version &

setting the battery type →**P.71**

## USB

Computer connection →**P.72**

Card reader →**P.73**

Using USB memory to

save and import data →**P.74**

Audio interface/control surface →**P.75**

R16 Effect types and parameters →**P.79**

Effect patch list →**P.89**

Specifications →**P.95**

Troubleshooting →**P.96**

Index →**P.97**

# Panel Layout and functions

## Rear panel

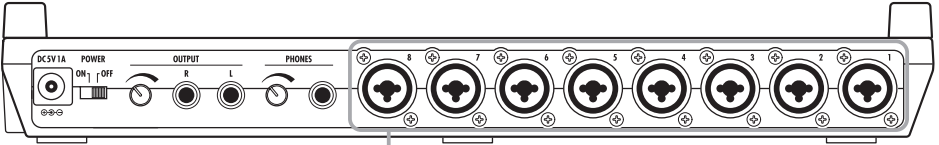

Input section

Control section

Level meters  
(1/9~8/16, MASTER)

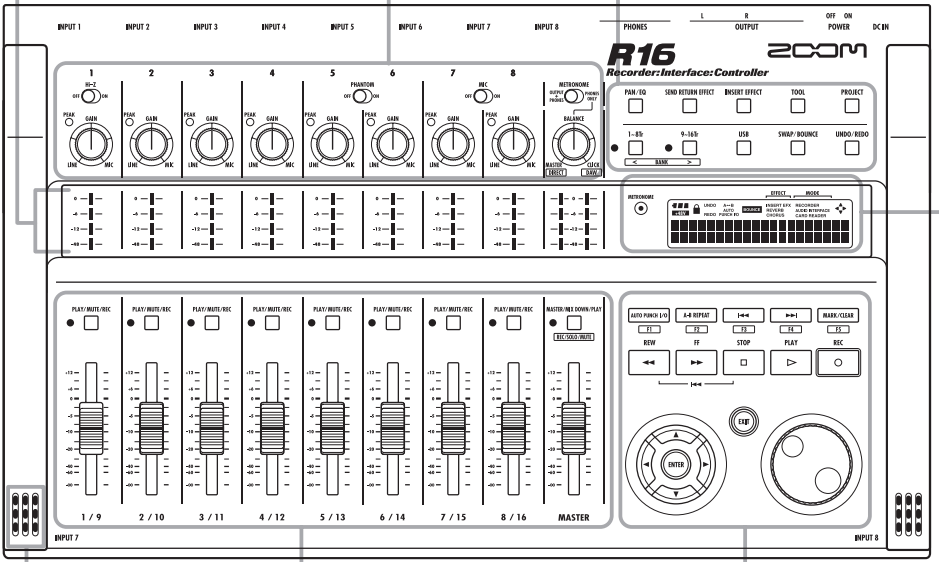

Fader section

Transport section

Built-in mic

METRONOME indicator

Display

Display section

## Right side panel

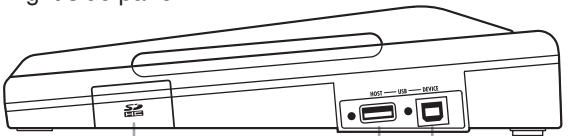

SD card slot

USB HOST jack

USB DEVICE jack

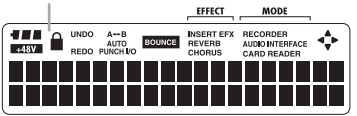

## Bottom panel (not shown)

Battery compartment



### Input section

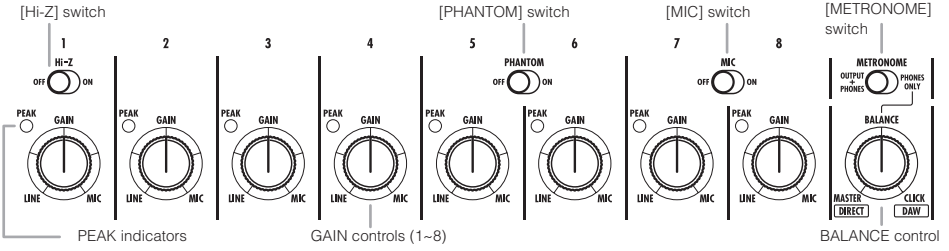

### Fader section

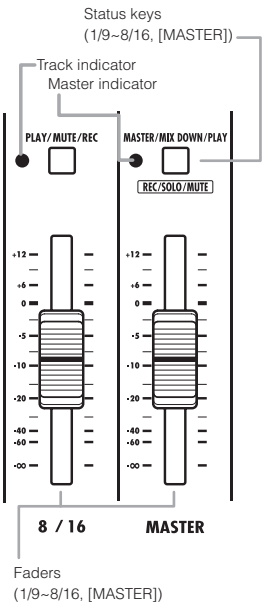

### Control section

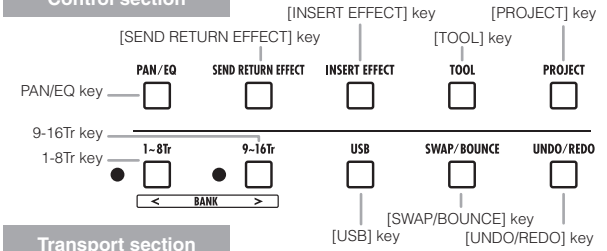

### Transport section

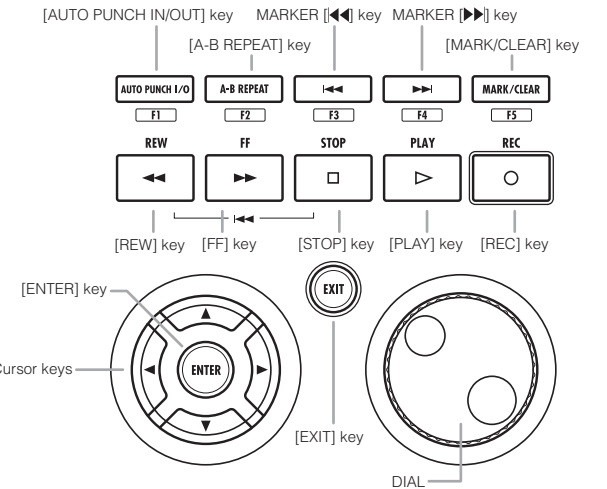

### Rear panel

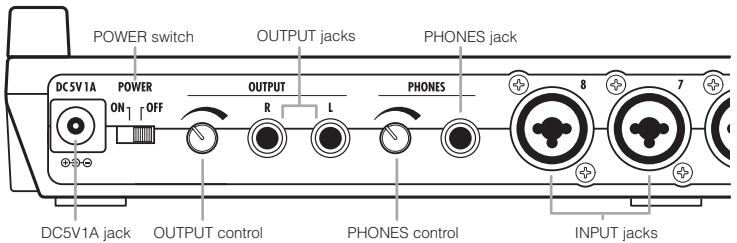

# Connections

Refer to the instructions on this page when you connect instruments, microphones, audio equipment or a computer to the R16.

## OUTPUTS

Use the [METRONOME] switch to set whether the metronome is output to only the [PHONES] jack or also to the [OUTPUT] jacks.

### 1) Stereo system, speakers with built-in amplifiers, etc.

When connecting speakers, be sure to turn off the system's power beforehand.

Connecting them with the power on could cause damage.

## INPUTS

You can connect cables with XLR and monaural phone plugs (balanced or unbalanced) to the INPUT jacks.

### 2) Microphones

In order to supply phantom power to a condenser microphone, first connect the microphone to [INPUT 5/6] and then turn the [PHANTOM] switch ON.

### 4) Guitar/Bass

Use [INPUT 1], which can handle high impedance, when you directly connect a passive-type electric guitar or bass, and turn the [HI-Z] switch ON.

### 3) Other equipment with stereo outputs

When using a synthesizer or a CD player with stereo outputs, for example, be sure to connect its left output jack to an odd number [INPUT] jack on the R16 and its right output jack to an even number [INPUT] jack on the R16.

### 5) Built-in microphones

These microphones are useful for recording drums indirectly and recording a band. When you turn the [MIC] switch ON, the sounds will be input into INPUT 7 and 8.

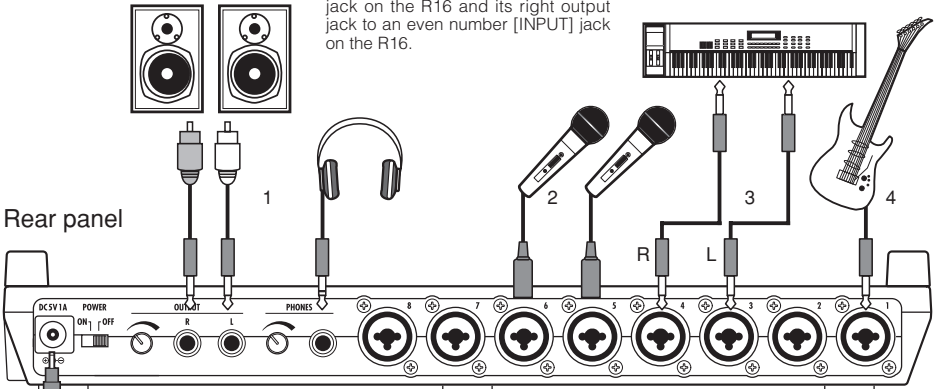

### 8) AC adapter

Make sure to use a ZOOM AD-14 adapter designed for this unit.

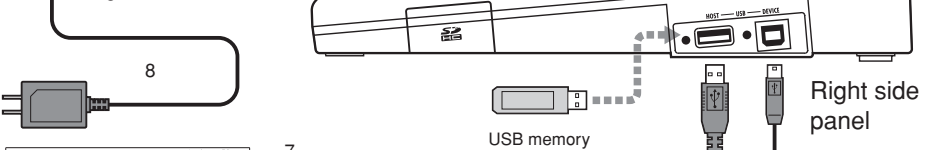

Right side panel

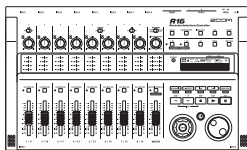

### 7) Connecting two R16s

By connecting two R16s together, you can record 16 tracks simultaneously.

### 6) Connecting a computer by USB

Connecting to a computer, you can send audio files and projects directly to and from the R16. You can also use the R16 as an audio interface and a control surface for DAW software.



# SD card installation

The R16 saves recording data and settings on SD cards.  
To protect your data, turn the [POWER] switch OFF when inserting or ejecting a card.

An SD card is necessary for recording.

Always turn the [POWER] switch OFF first  
(ordinary use)

- 1) Turn the [POWER] switch OFF and detach the cover of the SD card slot.

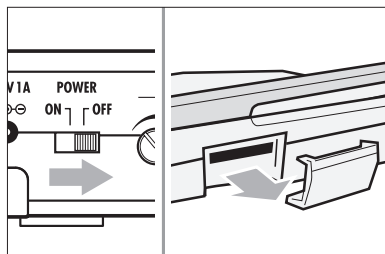

- 2) Insert an SD card (write-protect unlocked) into the slot.  
To eject: Push the card in first to eject it.

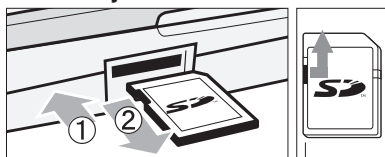

Unlock the SD card write-protection.

Prevent unwanted removal of an SD card

- 1 First remove the screw beside the slot, and then screw it into the screw-hole in the SD card cover.

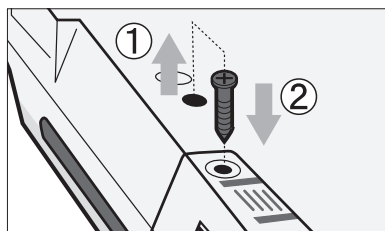

## NOTE

- If you must change an SD card while the power is on, please follow the specific procedures described on page 69.
- When inserting or ejecting an SD card make sure the [POWER] switch is OFF. If you insert with the [POWER] switch ON, your data might be lost.
- If you cannot insert a card into the slot, you may be trying to insert it in the wrong direction or upside-down. Try again with the correct card orientation. If you force it in, you might break the card.
- If an SD card was previously used with a computer or a digital camera, you must format it in the R16 before using it.
- If no SD card is inserted, [REC] and [UNDO/REDO] keys will not function in RECORDER MODE.

## If these messages about SD cards are shown

- "No Card": No SD card is detected. Make sure an SD card is inserted properly.
- "Card Protected": The SD card write-protection lock is closed, preventing rewriting. To release it, slide the switch away from the lock position.
- "SD Card Format?": The inserted card is not formatted for the R16. Press the [ENTER] key to format it. (Ref. P.70)

## HINT

- The R16 can use 16 MB – 2 GB SD cards and 4–32 GB SDHC cards.
- You can get up-to-date information about compatible SD cards on the Zoom site.  
Zoom site: <http://www.zoom.co.jp>

Ref: SD CARD >EXCHANGE  
SD CARD >FORMAT

P.69

P.70

# Powering the R16

Please use the included AC ADAPTER that is designed for the R16 or six AA batteries (sold separately).

Using the included AC ADAPTER with an ordinary electricity supply

- 1 **Make sure that [POWER] is OFF, and then plug the included AC ADAPTER into the back of the unit.**

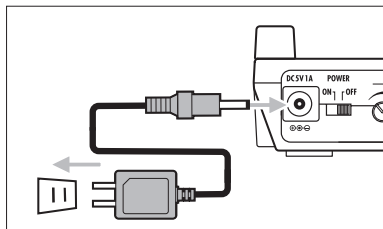

You must use the included ZOOM AD-14 AC ADAPTER, which is designed for the R16. Using any adapter other than the AS-14 may damage the unit and void the warranty.

## HINT

### Power supply from USB

With the [POWER] switch OFF, connecting a computer to a USB cable makes the R16 start-up automatically with power supplied by USB.

In this status, functions are different from when the [POWER] switch is ON. The R16 can be used only as an SD Card Reader or as an audio interface.

🔗 Ref.: R16 Battery type settings  
BATTERY TYPE

P.69

Using batteries

- 1 **Turn the [POWER] switch OFF and open the battery case cover on the bottom of the unit.**
- 2 **Install six AA batteries and close the cover.**

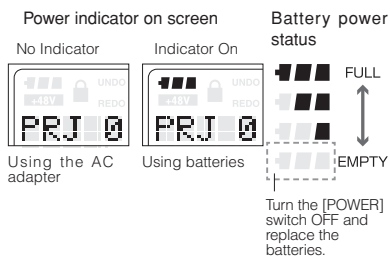
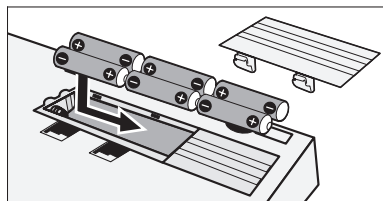

## NOTE

- Make sure that the [POWER] switch is OFF when you open/close the battery cover or plug/unplug the AC adapter. Removing batteries or unplugging the AC adapter when the [POWER] switch is ON, might cause lost recording data.
- The R16 can only use Alkali and NiMH batteries. The approximate lifetime for Alkali batteries is about 4.5 hours.
- Replace the batteries when you notice "Low Battery" or the empty battery icon on the display. Turn the [POWER] switch OFF immediately and install new batteries, or connect the included AC adapter.
- Be sure to set the correct BATTERY TYPE setting for accurate battery metering.

# Powering the R16 · Date & time setting

Precautions for starting-up and shutting down and how to set the date and time for files and data

## Turning the power on and off

- 1) Make sure the power is off on all equipment.
- 2) Insert an SD card into the R16. Confirm that the connections for the power, instruments, and monitoring system (or stereo headphones) are correct.

### Turn [POWER] switch ON: Start-up

**1**

**POWER**  
ON | OFF Turn the [POWER] switch ON.

ZOOM R16  
Ver: 1.00

PRJ 000 PRJ000  
000 00:00:00:000

- 2** Turn power on for connected instruments and then for the monitoring system.

### Turn [POWER] switch OFF: Shut-down

**1**

**POWER**  
ON | OFF Turn the [POWER] switch OFF.

Project Saving...

Goodbye See you!

## NOTE

- Before turning the [POWER] switch ON, turn the volume down on all instruments and the monitoring system connected to the R16.
- If no power is supplied to the R16 for more than 1 minute, the DATE/TIME setting will be reset to its initial value.

## Setting the date and time

TOOL>SYSTEM>DATE/TIME

**1** **TOOL** Press [TOOL].

TOOL  
>TUNER

Use the cursor keys to move in the Menu

**2** Select >SYSTEM.

TOOL  
>SYSTEM

Move with the cursor keys

**3** Press [ENTER].

SYSTEM  
>LCD

Move with the cursor keys

**4** Select >DATE/TIME.

SYSTEM  
>DATE/TIME

Press [ENTER].

**5** Select items under >DATE/TIME. Make setting for the year, month, day and time (hour: minute: second).

DATE TIME  
2009/01/01 00:00:00

Move with the cursor keys

Selected figure blinks

**6** Change the time

DATE TIME  
2009/03/01 00:00:00

DATE TIME  
2009/03/10 10:15:03

Rotate the DIAL to change the numbers.

Press [ENTER].

## If this is displayed:

Reset  
DATE TIME

- The DATE/TIME setting has been set to its initial value. Reset the DATE/TIME settings.

# Switch and key operation overview



Here we explain how to use the keys of the R16 and their functions. Please look at the display for keys that have icons shown on the screen.

## Transport section





**REC** [REC] key  
 Functions only when tracks are in recording standby.  
 This key puts the R16 in recording standby mode.  
 When in recording standby this key stops recording standby.

**PLAY** [PLAY] key  
 This key starts playback.  
 When in recording standby this key starts the recording.

**STOP** [STOP] key  
 When recording this key will stop the recording.  
 This key stops playback.

**REW** [REW] key  
 Rewind.  
 Press [REC] and [REW] keys at the same time to return to the top of the song.



**FF** [FF] key  
 Fast forward.

 [ENTER] key	Confirms selections
 [EXIT] key	A quick press returns to the previous step, and a long press returns to the top screen.
 [DIAL]	Use to change and move among menus and numbers.
	Ref.: Mark-related keys see P27.

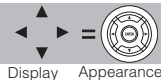
## Cursor: Appearance and indication









The display shows cursor directions



Display	Manual notation
	 <p>Black: direction explained                      Gray: movable directions                      No color: not effective</p>

Use the cursor to move up, down, left and right to choose different function items. The appearance of the display and its notation in the manual is shown above.

## Control section

 [PAN/EQ] key	Press to access track mixer settings → P.41
 [TOOL] key	Opens TOOL menu (TUNER, METRONOME, SYSTEM and SD CARD)
 [PROJECT] key	Opens PROJECT menu
 [1-8Tr] & [9-16Tr] keys	Select tracks 1-8 or 9-16 with light showing selected tracks
 [USB] key	Opens USB menu
 [SWAP/BOUNCE] key	Opens SWAP/BOUNCE menu

## Fader section

 TRACK 1-8 (9-16) status keys	Change track ready status Green: PLAY (playback) No light: MUTE (mute) Red: REC (record)
 MASTER status key	Change MASTER track status Green: PLAY (playback) No light: MASTER (not playback/recording ready) Red: MIX DOWN (recording)

## Various switches & controls

[POWER] switch	Turns power ON & OFF
[Hi-Z] switch	Turns Hi-Z connection on/off (only for INPUT 1).
[MIC] switch	Turn built-in microphones on/off (signals to INPUT 7 & 8).
[METRONOME] switch	Set metronome output.
[GAIN] controls	Adjust input sensitivity
[PEAK] indicators	Light at the moment of maximum input
[BALANCE]	When [METRONOME] is set to "PHONES ONLY" during recording, this adjusts the balance of the pre-MASTER fader and metronome signals
Level meters	Show recording/playback levels
[METRONOME] indicator	Flashes in time with the count

During audio interface use, control surface functions (shown in boxes below keys) are provided by the row of keys starting with AUTO PUNCH I/O (F-1 to F-5), as well as the [1-8Tr] and [9-16Tr] keys (<BANK>) and the [MASTER/MIX DOWN/PLAY] (REC/SOLO/MUTE) key.

# Display information

On the R16's display you can see project data, recorder connection and operation status, computer audio-interface connection and status, available functions and the R16 menus.

## Display and indications

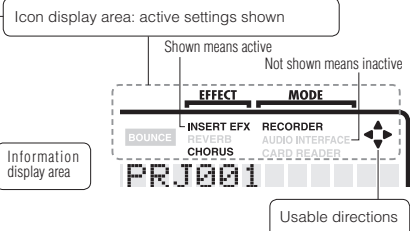
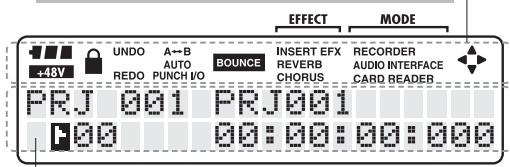

The TOP screen shows the current projects.  
 Top line: project number and project name  
 Bottom line: icon mark/number and counter (time)

## MENU screens show operation menus



Top line: current menu  
 Bottom line: menu & items available  
 Page in menu/total number of pages

## Effect & Mode



Send return effects → P.48  
 REVERB/CHORUS icons  
 Shown when on, set by key operation

INSERT EFX icon P.48  
 Shown when insert effects on, set by key operation

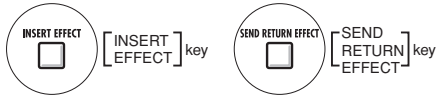

Key operation: Open effect menus

## MODE

Displays current R16 operation mode  
 Recorder → P.17-  
 Audio Interface → P.75-  
 Card reader → P.73

## Icon display and setting keys

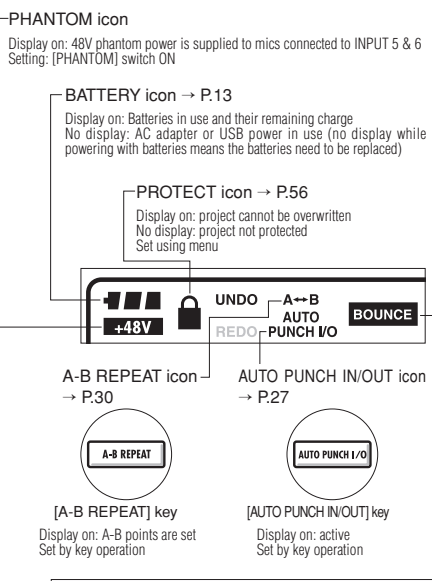

**BOUNCE icon**  
 → P.37  
 Display on: active

## [UNDO/REDO]



**UNDO:** You can return to the previous recording operation  
 Valid UNDO operations: PUNCH IN/OUT, BOUNCE, MIX DOWN (to MASTER TRACK)  
**REDO:** Reverse the UNDO operation

Icon shown/not shown  
 After certain operations, "UNDO" is displayed, meaning an UNDO operation is possible  
 After pressing the [UNDO/REDO] key, "REDO" is displayed, meaning a REDO operation is possible.  
 Set by key operation.

## NOTE

- UNDO is only valid for audio data recorded on tracks.
- You can only UNDO and REDO one operation.

# R16 recording flow • Creating a new project

With multitrack recording you can create a complete work of music using the R16. To begin, create a new project for each piece.

## Recording preparation

### Connect instruments to the appropriate INPUT jacks

### Make project and track settings

Create a new project

Select the INPUTS and the recording tracks

Set stereo links

Change track status (recording, play, mute)

Adjust input sensitivity using the [GAIN] controls

## Performance preparation

Set PRE-COUNT/METRONOME

Set and use TUNER

## Record the first tracks

Record standby—Record—Stop

## Record more tracks

Overdubbing

Playback of already recorded tracks

Overdubbing

Record standby—Record—Stop

## Create a new project

PROJECT>NEW

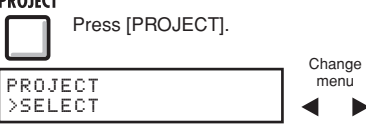
- 1 **PROJECT**  

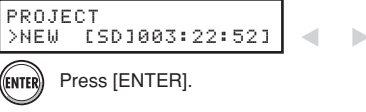

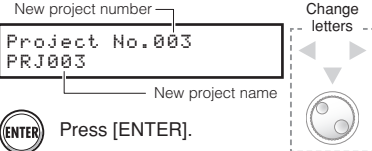
Press [PROJECT].
- 2 Select >NEW.  

Press [ENTER].
- 3 Confirm the PROJECT name.  

New project number

Project No.003  
PRJ003

New project name

Press [ENTER].
- 4 Select whether to use the settings of the last project.  

Press [ENTER].

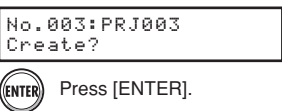
Select this to restore the default values
- 5 Execute.  

Press [ENTER].

## HINT

You can change the new project name at Step 3.

Ref: Name change

P.43

Using the previous settings

P.57



# Connecting instruments and making monaural settings

You will need to adjust settings for musical instruments such as high impedance guitars, line input synthesizers, the built-in microphones and microphones that use phantom power, as well as stereo and monaural inputs, for example.

## Connecting passive-type guitars

Connect high impedance (Hi-Z) instruments to INPUT 1, and then turn the [Hi-Z] switch ON.

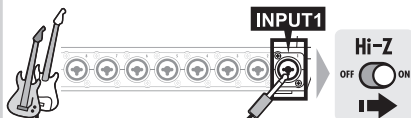

Signal to INPUT 1

## Connecting low-impedance instruments (monaural connection)

Connect low impedance instruments to any of the INPUTS.

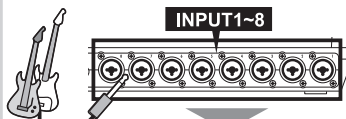

Signals to any INPUT between 1~8

## Using phantom power

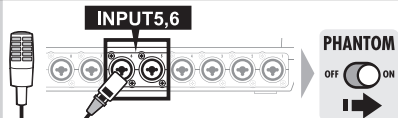

Supply phantom power to INPUT 5 and 6 jacks

## NOTE

\*Turn the [PHANTOM] switch on to provide +48V power to INPUT 5 and 6. You can use either INPUT 5 or 6 or both when the switch is ON.

\*Use the fader that corresponds to the INPUT jack. The signal from INPUT 1 goes to track 1/9.

\*To use Track 9~16, switch the fader assignment by pushing the [9-16Tr] key.

\*Depending on the INSERT EFFECT selection, the output flow will change.

\*Creating one stereo file from two faders requires the use of the STEREO LINK setting.

## Assign INPUT 1-8 connections to tracks 1-16

### 1 Connect instruments and microphones to jacks

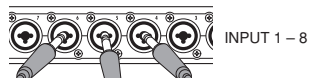

### 2 Make settings for specific instruments, built-in microphones and stereo tracks.



### 3 Select the Track switches



### 4 Change the status of the connected INPUTS

Press the status key of a track one or two times to turn the red light on.



## Set tracks to receive INPUTS

Press the [1-8Tr] or [9-16Tr] key to set which tracks will record the INPUTS.

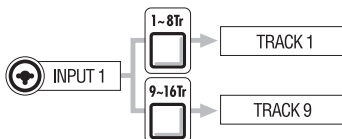

INPUT	TRACK	
	[1-8Tr] active	[9-16Tr] active
1	1	9
2	2	10
3	3	11
4	4	12
5	5	13
6	6	14
7	7	15
8	8	16

# Instrument connections: stereo settings and status keys

To make a stereo recording, you can create one stereo file by recording on the neighboring odd/even-numbered tracks and by setting a stereo link.

The status key must be pushed to transfer the signal from an INPUT to a recording track.

## Using the built-in microphones



Turn the [MIC] switch ON.

Signals to INPUT 7/8

## Connecting line input instruments (stereo connection)

Choose INPUT 1, 3, 5 or 7 and connect the musical instrument.

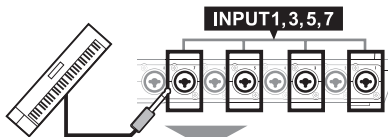

Use INPUT 1/2, 3/4, 5/6 and 7/8 as pairs. Input left signals to odd-numbered tracks and right signals to even numbered tracks.

## Assign INPUTS 1–8 to tracks 1–8 or tracks 9–16.

### 1 Connect instruments and microphones to the jacks.



### 2 Make stereo settings for the specific instruments and built-in microphones.

[STEREO] [MONAURALx2] [MONAURAL]

### 3 Select the tracks.

○ 1-8tr      ● 9-16tr  
TRACKS 1-8      TRACKS 9-16

Assign faders to either tracks 1–8 or 9–16

### 4 Set the status of the connected INPUTS.

Press the STATUS KEY of the paired tracks one or two times each to turn both lights on.



Red lights on: record ready (REC)

## Files corresponding to INPUTS

Recording INPUTS 1–8 results in file names that correspond with the track numbers.

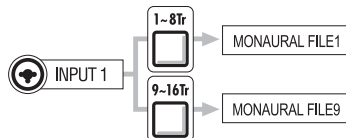

When STEREO LINK has been used

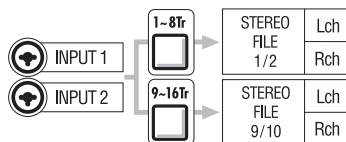

Stereo-linked tracks result in stereo files.  
Lch = odd-numbered input signal recorded  
Rch = even-numbered input signal recorded

## NOTE

- \* Use the fader that corresponds to the INPUT jack. Signals from INPUT 1 go into Track 1/9.
- \* To use tracks 9-16, press the [9-16tr] key to switch the fader assignments.
- \* The input and output flow change depending on the INSERT EFFECT setting.

# Stereo link

Set STEREO LINK for tracks for recording in advance to create a stereo file of the recording. You can also assign stereo files.

## STATUS KEYS and TRACK INDICATORS

Press a STATUS KEY to change the color of the TRACK INDICATOR light and set the role of the track fader. The three TRACK INDICATOR colors show the track status.

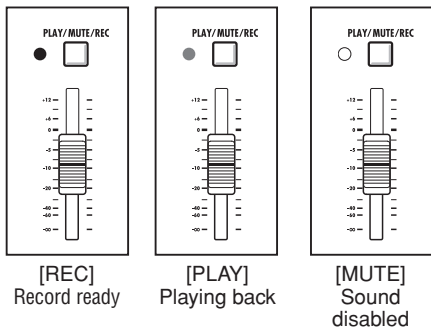

### PLAY/MUTE/REC



### MASTER/MIX DOWN/PLAY

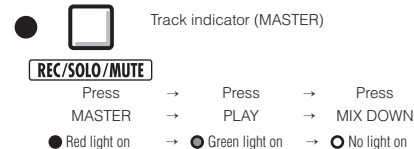

## HINT

- \* In order to send the signals from an INPUT to a recording track, press its STATUS KEY 1–2 times until the track indicator lights red.
- \* For use of two INPUTS press both STATUS KEYS to connect both INPUTS to tracks.
- \* Creating one stereo file from 2 tracks requires STEREO LINK to be set.
- \* If the MASTER track is set to PLAY, all other tracks will be set to MUTE (no sound).

## Stereo link

### PAN/EQ>STEREO LINK

- PAN/EQ**  
 Press [PAN/EQ].  
 Switch tracks.   
 Track 1  
 EQ HI G=0db   
 Change type Change parameter values
- Select a track.  
 Track 3  
 EQ HI G=0db
- Select STEREO LINK.  
 Track 3  
 STEREO LINK Off   
 Change setting
- Turn STEREO LINK On.  
 Track 3/4  
 STEREO LINK On   
 On/Off
- Press [EXIT] to complete the setting.

## HINT



- \* The STEREO LINK track pairs are Track 1/2, Track 3/4, Track 5/6, Track 7/8, Track 9/10, Track 11/12, Track 13/14 and Track 15/16.
- \* STEREO LINK changes the setting from two monaural tracks to one stereo track.
- \* At Step 4, whatever track number you choose, the neighboring number track will be linked. You cannot change these combinations.
- \* To adjust the volume of a pair of tracks set to STEREO LINK you must operate the odd number fader. The even number fader has no effect.
- \* The PAN parameter of a pair of tracks set to STEREO LINK can be used to adjust their relative volume balance.
- \* Even when STEREO LINK is active you can select files and make phase settings for each track.

# Recording the first track

After connecting instruments and completing all recording preparation, we can prepare the recorder and start recording the first track.

## Starting from the top screen of the new project

**1** Return to the top screen.  
 Press and hold [EXIT] for more than 2 seconds.

**2** Return the counter to its head.  
 +  Press [REW] & [Stop] at the same time to return the counter to its head.

The top screen should look like this.

```
PRJ 001 PRJ001
000 00:00:00:000
```

The counter is at the head position (mark 00).

## HINT

The top screen display of the new project



Counter at the head position (mark 00)  
 Batteries and phantom power active

After setting the input (Step 5 and after), you can process input signals with the INSERT EFFECT.

 Ref. : New project creation

P.17

Insert effect

P.48

## Adjusting the input level

**3** Arm the track for recording.

**PLAY/MUTE/REC** Press 1-2 times until the track light turns red.



Red light on: recording enabled (REC).

**4** Adjust the input sensitivity (GAIN).



Sounds start.

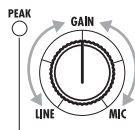

Adjust the recording level and monitor.

— Should light occasionally when the volume reaches maximum

**5** Adjust the recording level.

If an INSERT EFFECT is applied to an INPUT, make adjustments to the patch level, for example, to prevent the LEVEL METER red light (0dB) from turning on.

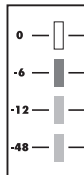

**6** Adjust the monitoring system

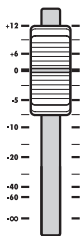

Using the recording track fader, adjust the monitoring level of the instrument being recorded. (INPUT 1 is track 1 or 9).

## NOTE

Red lights on PEAK indicators and Level meters

- A PEAK indicator turns red when the input signal exceeds the maximum detectable level of 0 dB, resulting in input clipping. The red light on a Level meter means that the signal being recorded (signal after passing through the insert effect) is clipping. If clipping happens, the recorded sound will be distorted. You should reduce the recording level.

## Recording the first track

7 Start record standby.

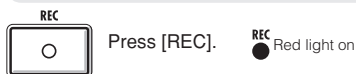

8 Start recording.

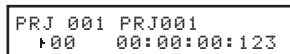
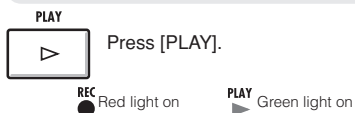

The counter starts to move.

9 Stop recording.

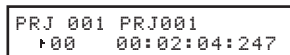
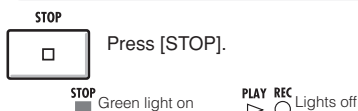

The counter stops moving, but does not return to 0.

## HINT

- Press [UNDO/REDO] to cancel the recording.
- Recording again**
- If you record on the same track again, the previous recording will be overwritten.
  - The three ways to record a new file or re-record are:
    - Press the [UNDO/REDO] key to execute the undo-action (cancel the recording).
    - Through PROJECT>FILE, set the recorded track assignment to "NOT ASSIGN." (Ref.: P.23)
    - Through PROJECT>FILE>EDIT>DELETE, delete the FILE (AUDIO DATA). (Ref.: P.62)

## Playing back the first track

10 Stop.

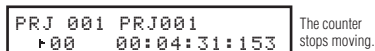

The counter stops moving.

11 Play the track.



12 Return the counter to its head.

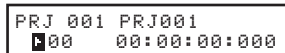
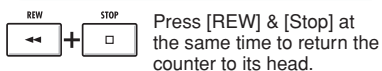

13 Play.

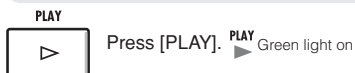

14 Stop.

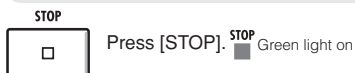

## NOTE

- Recorded audio files in a track will be recorded over. If you rewind the counter back to the head, a new recording will overwrite the previous one. During playback the files stored on the tracks will be played.
- If you want to record a new file, do not assign a file to the track.

Ref.: Assigning files to tracks

P.23

Mark

P.31

# Track assignment

Here, after completing the first track recording, we record the next track while playing back the already recorded audio file. The preparation is almost identical to the first one, but we will conduct playback on a different track.

## Playback track preparation

**1** Assign the playback file to a different tracks.

### PROJECT



Press [PROJECT].

```
PROJECT
>SELECT
```

**2** Select >FILE.

```
PROJECT
>FILE
```



Press [ENTER].

**3** Select the track for playback.

```
TRACK1
NOT ASSIGN
```



Select a different track from the one for the next recording.

**4** Select the file for the track.

```
TRACK5
MONO-000 [TR 5]
```



File change

**5** Assign it.



Press [ENTER].



```
TRACK5
MONO-000 [TR 5]
```

**6** Press and hold [EXIT] to return to the top screen.



**7** Prepare the already recorded track for playback.

### PLAY/MUTE/REC



Press the [PLAY/MUTE/REC] of the track to be played back 1–2 times until the green light turns on.

Green light on: playback enabled [PLAY].

## NOTE

- Recorded audio files on tracks will be overwritten by new recording. If you rewind the counter to the top and begin recording again, be aware that the overwritten previous recording will be lost.
- During playback the file assigned to the track is played.
- If you want to record to a new file, do not assign any file to a track.
- When you move a file on a track, confirm that no files are assigned to the track to be recorded ("NOT ASSIGN"). If there is any assigned file, that recording will be overwritten by new recording.
- Files exclusively for reading (read only) are shown with <R.O> on the display, and you cannot record over them if they are assigned to tracks.
- Files marked with an asterisk (\*) cannot be assigned to the selected track.

## HINT

- File track assignment status

```
TRACK 5
NOT ASSIGN
```

Display of a track with no file

```
TRACK 5
MONO-000
```

Display of track with no assigned files

```
TRACK 5
MONO-000 [TR 3]
```

Display of a track with assigned file

- If the first and second recordings are on different tracks, you can skip to Step 7, because you only need to change the track status and start recording.
- You can select tracks using the status key. The indicators of selectable tracks will light orange.
- You can assign files imported from a computer or USB memory.
- Stereo files can only be assigned to the tracks set to stereo link or the master track.

## Switch two tracks (SWAP)

**1** **SWAP/BOUNCE**  
 Press [SWAP/BOUNCE].

```
SWAP/BOUNCE
>SWAP
```

**2** Select >SWAP .

```
SWAP/BOUNCE
>SWAP
```

Menu  
change



 Press [ENTER].

**3** Select the first track to swap.

```
SELECT TRACK
```

Indicators blink orange on tracks that can be selected.  
Press the track status key to select a track.

PLAY/MUTE/REC



Selectable: blinking orange  
Selected: lit orange

**4** Select the second track to swap.

```
SELECT TRACK
TRACK1*
```

— Already selected track

Indicators blink orange on tracks that can be selected.  
Press the track status key to select a track.

PLAY/MUTE/REC



Selectable: blinking orange  
Selected: lit orange

**5** Swap the tracks.

— Tracks to be swapped

```
TRACK1+TRACK2
SwAP?
```

 Press [ENTER] to confirm.

## NOTE

- The swap function switches two tracks, including the assigned files and all track parameter information.
- Stereo tracks cannot be swapped.

## Recording the second and later tracks

After completing the first track recording, you can record the next track in turn while playing back recorded audio files. The preparation for recording is the same as for the first track, and you can playback on a different track.

### Playing back the already recorded track

- 1** **PLAY/MUTE/REC** ] Press the [PLAY/MUTE/REC] of the TRACK for playback 1-2 times until the green light turns on.
- Green light on: playback enabled [PLAY]

### Recording preparation for the second track

- 2** **PLAY/MUTE/REC** ] Press the [PLAY/MUTE/REC] of the recording track 1-2 times until the red light turns on.
- Red light on: recording enabled [REC]

- 3** Adjust the [GAIN].



Instrument starts sounding

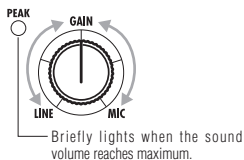

- 0 — Red
- 6 — Orange
- 12 — Green
- 48 — Green

The level should cause no red light (0dB) even at the maximum sound.

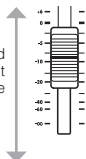

### Recording~Stop

- 4** **REW** + **STOP** ] Press [REW] & [Stop] at the same time to return the counter to the head.

```
PRJ 001 PRJ001
  00  00:00:00:000
```

- 5** **REC** + **PLAY** ] Press [REC] and then [PLAY] to start recording.
- Red light on    ▶ Green light on

```
PRJ 001 PRJ001
  00  00:00:00:123
```

The counter starts moving.



Perform.

- 6** **STOP** ] Press [STOP] to stop recording.

■ Green light on    ○ The lights off

```
PRJ 001 PRJ001
  00  00:02:04:247
```

The counter stops moving, but does not return to 0.

### NOTE

- If the first and second recordings are on different tracks, you can skip to Step 7, because you only need to change the track status and start recording.
- When you move file tracks, make sure there is no file assigned to the track where you plan to record (display says "NOT ASSIGN"). If there are assigned files, old files will be overwritten and cannot be retrieved.
- Select tracks using the STATUS KEYS. Orange lights indicate selectable tracks.
- Read-only files are displayed as <R.0> and cannot be recorded over if assigned.

### HINT

#### Other Uses

- If you want to use the same track as you recorded before for the second track recording, you should transfer the file to another track, and make the target track empty. Refer to "Preparation of playback tracks" on P.24.
- You can also swap recorded tracks with unrecorded tracks.
- This method is useful for creating a second guitar track using Hi-Z.



## Playback all the tracks

- 1** **PLAY/MUTE/REC**



Press the [PLAY/MUTE/REC] keys 1-2 times on all TRACKS to be played until the green lights are on.

Green light on: playback enabled [PLAY]
- 2**





Press [REW] & [STOP] at the same time to return the counter to the head.
- 3** **PLAY**



Press [PLAY] to start playback.

**PLAY** Green light on

- 4** **STOP**



Press [STOP] to stop playback.

**STOP** Green light on



## NOTE

- When you move a file on a track, confirm that no files are assigned to the track to be recorded ("NOT ASSIGN"). If there is an assigned file, that recording will be overwritten by new recording.
- Recorded audio files on tracks will be overwritten by new recording. If you rewind the counter to the top and begin recording again, be aware that the overwritten previous recording will be lost.
- During playback the file assigned to the track is played.

## HINT

- If you want to record a new file, do not assign any file to a track.

# Automatic punch-in/punch-out

The punch-in and punch-out functions enable you to pick already recorded portions of a recorded file and re-record them. You can set the beginning and ending points of the portion in advance and record automatically with punch-in at the beginning and punch-out at the ending.

## Prepare the track you want to re-record with punch-in/punch-out

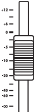
- 

Re-recording a track  
Raise the fader.
- 

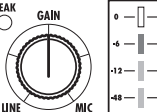

**PLAY/MUTE/REC** Press [PLAY/MUTE/REC] 1-2 times until the red light is on.  
Red light on: recording enabled
- 

**PEAK** **GAIN** Adjust the recording level and the GAIN to be the same as the already recorded part.  
**LINE** **MIC**

## Make punch-in and punch-out settings

- 

Using [REW], [FF] and [PLAY] locate the point just before the re-recording (PUNCH IN).
- 

Press [AUTO PUNCH I/O] Set the punch-in point.  
 Icon blinks
- 

Pressing [FF] & [PLAY], locate the punch-out point.
- 



Press [AUTO PUNCH I/O] Set the punch-out point.  
 Icon lights

### NOTE

- Once you make auto punch-in/out settings, you cannot change the points. To change the points you must cancel and reset them.
- Press the [AUTO PUNCH IN/OUT] key again to cancel the points set.

## Rehearse

- 







Press [PLAY] to start playing.  Light on  
When the punch-in point is passed, the [MUTE] function of the track automatically starts.
- 

Press [STOP] to stop.  Light off.  
Perform (not recording)  
When the punch-out point is passed, the [MUTE] function is released.

## Re-recording: punch-in/punch-out

- 

Move to before the PUNCH IN point.
- 

Press [REC] and then [PLAY] to start playback.  
 Light on  Light off Not recording.  
Pass the punch-in point  
Performance  Light on  Light off Recording.  
Pass the punch-out point  
 Light on  Light off Not recording.
- 

Press [STOP] to stop. The recorder stops.  
 Light off

## Release PUNCH IN/OUT

- 

Press [AUTO PUNCH I/O].  
 Icon off

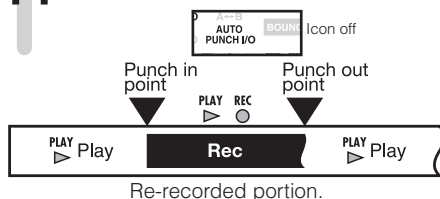

# Manual punch-in/punch-out

You can punch in and out manually. Press the [REC] key during playback to start re-recording from that point.

## Prepare the track for punch-in/punch-out

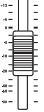
- 

Re-recording track  
Raise the fader
- 

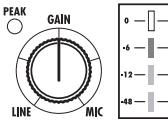
**PLAY/MUTE/REC** Press [PLAY/MUTE/REC] 1-2 times until the red light turns on.  
Red light on: recording enabled
- 

Adjust the recording level and the GAIN to be the same as the already recorded part.

## Re-recording: punch-in/punch-out

- 

Using [REW], locate the point just before where you want to re-record.
- 

Press [PLAY] to start playback. **PLAY** Light on
- 

Start performance, not yet recording
- 

Press [REC] to start recording, (punch-in) **PLAY REC** Lights on
- 

Perform and record.
- 

Press [REC] to stop recording/start playback (punch out). **PLAY** Light on **REC** Light off
- 

Press [STOP] to stop. The recorder stops. **PLAY REC** Lights off

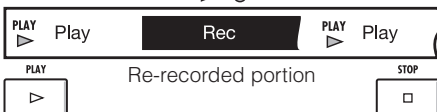

## NOTE

- Punch-in/punch-out recording overwrites the existing recording. A previously recorded file should be assigned to the track.
- You can use the [UNDO/REDO] function.

# Playback of a project

Recorded audio files are assigned to tracks for storage. During playback, all the tracks that you have enabled for playback with their status keys (green lights on) will be played.

## Overview of recording and playback process in a project

TRACK 1/9	TRACK 2/10	TRACK 3/11	TRACK 4/12	TRACK 5/13	TRACK 6/14	TRACK 7/15	TRACK 8/16	MASTER TRACK
--------------	---------------	---------------	---------------	---------------	---------------	---------------	---------------	-----------------

### Recording the first track

Track 1: monaural recording

Track 7 & 8: stereo recording

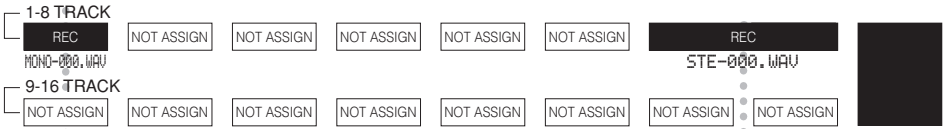

### Recording more tracks/Playback of the previously recorded tracks

Monaural recording on tracks 11, 12 and 13

Track 1: monaural playback



### Playback

Track 1, 11, 12 and 13: monaural playback

Track 7 & 8: stereo playback

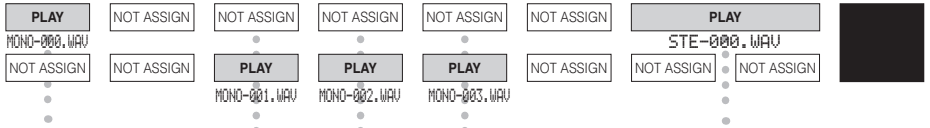

### Assigning tracks and playback

Track 1, 2, 3 & 4: monaural playback

Track 7 & 8: stereo playback

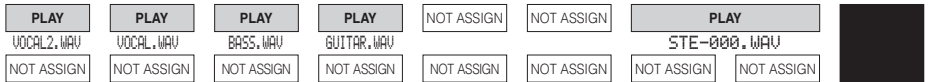

Ref. : Assigning files to tracks.

# Repeat playback of a specific section (A-B repeat)

You can set and repeat playback between a beginning point (A) and an ending point (B) in a project.

## Setting A-B points

**1**  Locate the beginning point.

**2**  Press [A-B REPEAT].



A↔B blinks.

**3**  Locate the end point.

**4**  Press [A-B REPEAT].



A↔B icon

## A-B repeat: playback repeatedly

**5**  Press [PLAY] to start repeat playback.

**6**  Press [STOP] to stop playback.

## Cancel A-B repeat and the points

**7**  Press [A-B REPEAT] again to cancel.

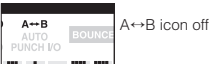

A↔B icon off

## HINT

- When playback reaches point B, it automatically goes back to point A and continues playback.
- While the A↔B icon is on, playback repeats continuously.
- You can make these settings both during playback and when stopped.
- If you set point B at a time before point A, repeat playback will start from point B.
- If you want to make new settings, cancel the previous ones by pressing the [A-B REPEAT] key again and then make the new ones.

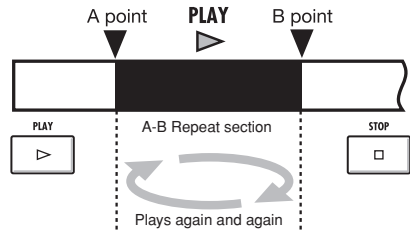

## Using the counter and markers to move (locate)

The counter indicates recording time and elapsed time in minute/second/millisecond and bar/beat/tick (1/48beat). Use it to set marks that you can then quickly move (locate) to in your project.

### Locate a time or position using the counter

Preparation: Stop the recorder.  
Select the project.  
Start from the top screen.

#### 1 Select hour: minute: second or bar-beat-tick.

PRJ01 PRJ001  
00 00:00:00:000

Hour: minute: second: millisecond



PRJ01 PRJ001  
00 00 - 00 - 000

Bar-beat-tick (1/48 beat)



#### 2 Choose the desired unit. (Hour: minute: second: millisecond or bar-beat-tick.)

PRJ01 PRJ001  
00 00:00:00:000

Move between units, the selected item blinks



#### 3 Change the values.



PRJ01 PRJ001  
00 00:15:00:000

Move between items



### Place a mark

#### Place a mark using the counter

Start from the top screen.  
Set the counter to the desired mark position.

PRJ01 PRJ001  
00 00:01:12:037

Move between items



#### 1 MARK/CLEAR Press [MARK/CLEAR].

PRJ01 PRJ001  
001 00:01:12:037

Mark number  
Marker icon

#### Place a mark during recording/playback

In the middle of recording/playback

PRJ01 PRJ001  
00 00:06:19:004

#### 1 MARK/CLEAR Press [MARK/CLEAR].

PRJ01 PRJ001  
001 00:06:19:004

### HINT

Mark icon display

03 000:10:08:015

Mark number 3 is located at 10 minutes, 8 seconds, 15 milliseconds.

- Counter is at the indicated mark
- No mark registered at this counter position

Mark Numbers

- Mark 0 = Counter 0. This is the head of the project. You cannot change this particular mark.
- If you place a new mark ahead of a registered mark, all the following marks will be automatically renumbered in order.
- You can place a maximum of 100 marks in one project.

### NOTE

- You cannot use these procedures during recording/playback.

### HINT

- After Step 3 you can start playback from the set counter value.

## Locate to the position of a mark

With key operations you can move between marks

1



Press the forward or backward mark key until you reached the desired mark.

```
PRJ01 PRJ001
┆03  00:12:00:037
```

Project

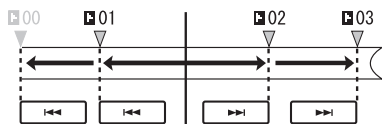

Move to mark numbers in counter sequence

1

Choose a mark.

```
PRJ01 PRJ001
┆00  00:00:00:000
```

Move between items



Blinks

2

Choose the mark number.

```
PRJ01 PRJ001
┆03  00:12:00:037
```

## Delete a mark

1



Press the forward and backward mark keys until you reach the desired mark.

```
PRJ01 PRJ001
┆03  00:12:00:037
```

2

**MARK/CLEAR**

Press [MARK/CLEAR].

```
PRJ01 PRJ001
┆02  00:12:00:037
```

The selected (highlighted) mark is erased and the preceding mark is shown (the counter does not move).

## NOTE

- Once you delete a mark, you cannot retrieve it.
- You cannot delete the top mark **┆00**.

## HINT

- If you press the [MARK/CLEAR] key at a place where a mark exists (mark icon highlighted), that mark is deleted. If there is no mark at a location (icon not highlighted), a new mark is placed there. To delete a mark, you must move to it first (mark icon highlighted).
- When placing and deleting marks, numbers are automatically given in order from the beginning.

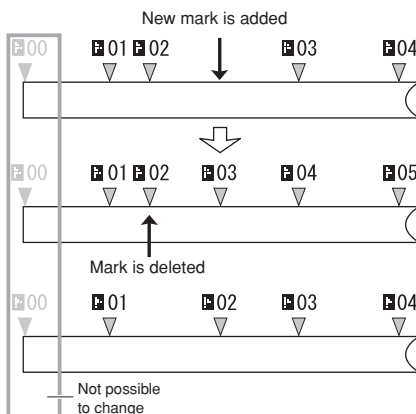



# Tuner

The R16 has a multifunctional tuner that includes, for example, chromatic tuning that detects note names by semitones, standard guitar/bass tuning and half-step-down tuning.

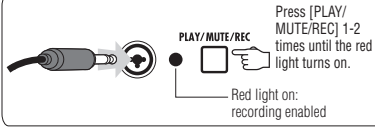
**1** **TOOL**  
 Press [TOOL].

**2**  
 Press [PLAY/MUTE/REC] 1-2 times until the red light turns on.  
 Red light on: recording enabled

**3** Select >TUNER.  
 Menu select

**4** Select the type of tuner.  
 Press [ENTER].

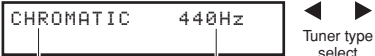
Select the type of tuner.  
 Tuner type select  
 Standard pitch  
 Change the standard pitch

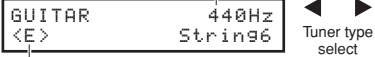
Select the type of tuner.  
 Tuner type select  
 String note name

## Chromatic tuner

TOOL>TUNER>CHROMATIC

**5** CHROMATIC 440Hz  
 Change the standard pitch



 Change the standard pitch (if necessary) and begin tuning.

CHROMATIC 440Hz  
 >>A  
 The note closest to the input signal is indicated.  
 This display indicates if the pitch is higher or lower compared to the note indicated.

## Other tuner types

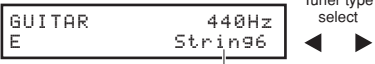
TOOL>TUNER>GUITAR/BASS, etc.

**5** Select the tuner type.  
 Tuner type select  
 Change string number  
 Change standard pitch

**6** Set the standard pitch and string number. Start tuning.  
  
 Tuner type select

Note name: play the open string of the indicated note and adjust the pitch

## HINT

Pitch indicator

Low ← Standard

> A > A >>A >A <A>

<A> A< A<< A< A<

Standard → High









- The pitch indicator responds to sources input on tracks with red status lights.
- The standard pitch setting is between 435 Hz and 445 Hz in 1 Hz units. The initial setting is 440 Hz.
- Using the other tuners you can use common half-step and whole-step down tunings, for example.
- The standard pitch value setting will be stored separately for each project.

	Tuner type	GUITAR	BASS	OPEN A	OPEN D	OPEN E	OPEN G	DADGAD
String/ note	String1	E	G	E	D	E	D	D
	String2	B	D	C#	A	B	B	A
	String3	G	A	A	F#	G#	G	G
	String4	D	E	E	D	E	D	D
	String5	A	B	A	A	B	G	A
	String6	E		E	D	E	D	D
	String7	B						

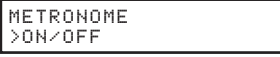

# Metronome

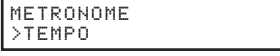
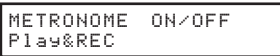
This metronome, which includes a pre-count function, allows you to change its volume, tone and pattern. You can also choose to output the metronome sound only through the headphones.

- 1 **TOOL**  
 Press [TOOL].  
 Change menu  

- 2 Select **>METRONOME .**  

 Press [ENTER].  
 These are the standard metronome settings (common).
- 3 Select each setting MENU.  
 Change menu  

- 4 Select the settings and setting values.  
 Change item  

 Press [ENTER].

## HINT

### Tapping the tempo

- On the TEMPO screen, press the (TOOL) key several times at the tempo you desire, and the tempo will be set to the detected median value.

### Changing and adjusting the metronome output

[METRONOME] switch: Sets the output

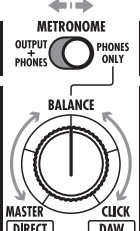

**OUTPUT + PHONES**  
The METRONOME sound is output through both the OUTPUT and PHONES jack.

**PHONES ONLY**  
The metronome sound is output through only the PHONES jack.  
Use the BALANCE knob to adjust the relative volumes of the [MASTER] fader signal and the metronome sound.

**MASTER**  **CLICK**  
(metronome)

- These settings are stored for each project.
- You can use the metronome even during MASTER TRACK playback.

## MENU settings and setting values

ON/OFF: Set when active	
Settings	
Play Only	During playback only
REC Only	During recording only
Play&REC	During both playback & recording
Off (default)	No metronome sound
TEMPO: Set manually or by number	
Manual input	Input the tempo by tapping the [TOOL] key repeatedly
Setting range	
40.0~250.0	Initial value: 120.0
LEVEL: Change metronome volume	
Setting range	
0-100	Initial value: 50
PAN: Stereo position	
Setting range	
L100-R100	Initial value: C (center)
SOUND: Change tone	
Settings	
BELL (default)	Metronome sound with a bell on the accent
CLICK	Click sound only
STICK	Drum stick sound
COWBELL	Cowbell tone
HIGH-Q	Synthesized click sound
PATTERN: Change rhythm	
Settings	
0/4 (no accent) 1/4~8/4, 6/8	Initial value: 4/4
PRE-COUNT: Pre-count setting	
Settings	
Off	No sound
1~8	Enable sound during pre-count for 1 to 8 beats. Initial: 4 beats
SPECIAL	Special (rhythm shown below)

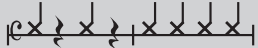

## NOTE

Be aware that the metronome starts sounding from the instant that recording/playback begins. Therefore, if you begin in the middle of a song, the metronome sound and the pulse of the music might be out of sync. Moreover, if you turn the metronome volume up high, the accented beat of some sounds might become difficult to distinguish.

### METRONOME Metronome indicator







-  During metronome use the metronome indicator lights in time with the tempo.

# 16-track synchronized recording by connecting two R16s

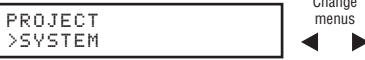
If you want to record more than 8 tracks at the same time for a band performance, for example, you can increase the number of tracks by connecting two R16s with a USB cable.

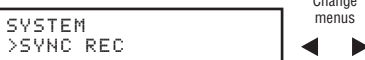
## Make sender settings.

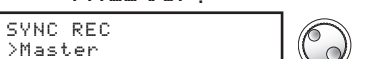
Set the R16 that will be used for key control as the Master.





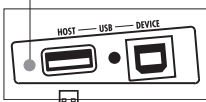

- 1 **TOOL**  Press [TOOL].
- 2 Select >SYSTEM.  
 Change menu  
 Press [ENTER].
- 3 Select >SYNC REC.  
 Change menu  
 Press [ENTER].
- 4 Select >Master.  
 Master/Slave  
 Press [ENTER].

USB Indicator: [HOST] light on

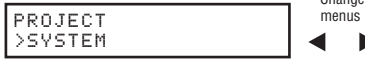

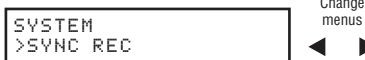
## Make receiver settings.

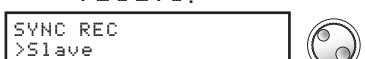
Set the R16 that receives commands as the Slave.

- 1 **TOOL**  Press [TOOL].
- 2 Select >SYSTEM.  
 Change menu  
 Press [ENTER].
- 3 Select >SYNC REC.  
 Change menu  
 Press [ENTER].
- 4 Select >Slave.  
 Master/Slave  
 Press [ENTER].

USB Indicator: [DEVICE] light on.

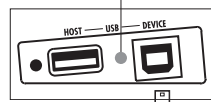

## 5 Connect two R16 with a USB cable.

Plug a USB 2.0 (AB-type) cable into the socket that has a lit indicator.

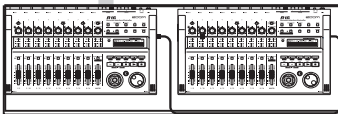





## NOTE

- Perfect synchronization of the start timing in recording by two R16s is not guaranteed.
- There will be a gap of approximately 1-2 ms.

## HINT

Command keys that effect both sender and receiver.

	[REC] key		[FF] key
	[PLAY] key		[REW] key
	[STOP] key		

# R16 mixing procedure flow

Use the track mixer to make stereo link settings, to adjust sound volume, EQ and PAN (balance), and to adjust the send signal strength, which affects the depth of send return effects.

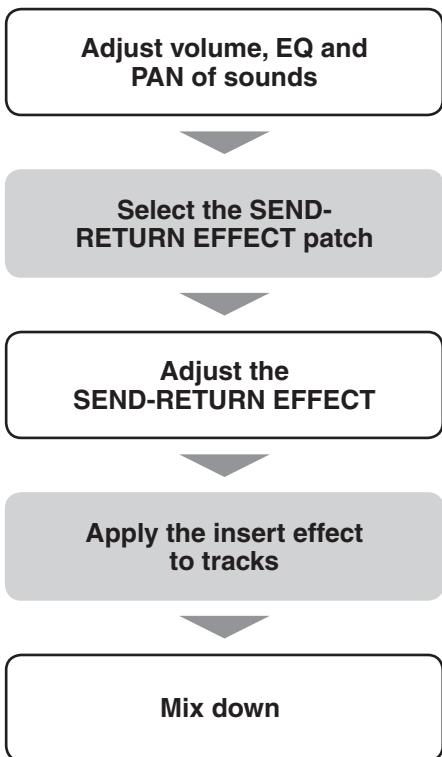

## NOTE

- When you are using a stereo track, except for the phase setting, parameter values are shared by both L and R channels.

## HINT

### What is the track mixer?

- This mixer can mix audio tracks from the recorder into stereo.
- You can adjust the sound volume and PAN and EQ parameters of each track using its fader.

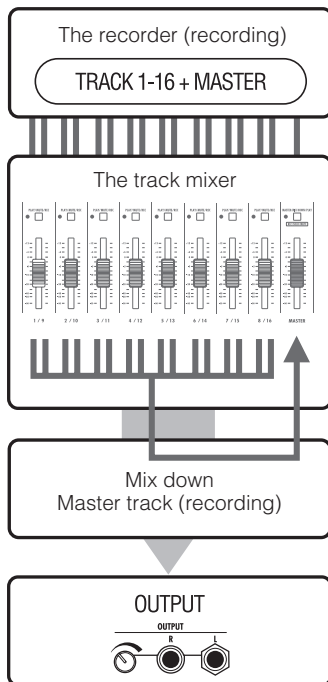

# Track settings for EQ, pan and send-return level

This track mixer uses track parameters to adjust PAN (stereo position), EQ (equalizer) and SEND-RETURN EFFECT of the recorder's audio tracks.

**1** **PAN/EQ**  Press [PAN/EQ].



Track

Track 1  
 EQ HI G=0dB

Parameter

Type (EQ is on)

**2** Select a track.

Change track number  

Track 1  
 EQ HI G=0dB

**3** Turn ON/OFF and select types and values.

Turn setting off.

Track 3  
 EQ HI G=0dB

EQ is ON





Track 3  
 EQ HI Off

Press [ENTER].

Parameter ON/  
OFF.

Change the parameter type.

Track 3  
 EQ HI G=0dB

  

Track 3      PAN=R2  
 |-----+-----|

Change the parameter type.

Adjust the value of the parameter.

Track 3  
 EQ HI G=0dB



Adjust the value of the parameter.

**4**  Press [ENTER] to confirm settings.

## HINT

- Using the track mixer, you can adjust each track element (track parameter), including PAN and the SEND-RETURN EFFECT settings to change the signal processing track by track.
- At step 2, tracks can be selected using track status keys. Track indicators light orange when the track is selected.

## NOTE

- The parameters of the L/R channels in stereo tracks are the same except the phase setting (INVERT).
- The settings are stored with the project.
- The MASTER TRACK does not have any settings except for volume control with its fader.

# Track parameters

Parameters available to each track

Monaural tracks: 1 ~ 16  
Stereo tracks: 1/2 ~ 15/16

Display	Parameter	Setting range: Initial value	Explanation	Monaural tracks	Stereo tracks	Master track
<b>PAN</b>	PAN	L100~ R100	Adjusts a track's PAN. In case of a stereo track adjusts the volume balance between the left and right tracks.	<input type="radio"/>	<input type="radio"/>	
EQ HI EQ boost for high pitch/frequency range						
<b>EQ HI G</b>	EQ HI GAIN*	-12~ +12dB :0dB	Adjust amount of boost/cut of high frequencies by -12 ~ +12 dB. This parameter is shown only when EQ HI is on.	<input type="radio"/>	<input type="radio"/>	
<b>EQ HI F</b>	EQ HI FREQUENCY*	500(Hz)~ 18(kHz) :8.0(kHz)	Adjust EQ boost/cut frequency of high frequencies. This parameter is shown only when EQ HI is on.	<input type="radio"/>	<input type="radio"/>	
EQ MID EQ boost for middle pitch/frequency range						
<b>EQ MID G</b>	EQ MID GAIN*	-12~ +12dB :0dB	Adjust amount of boost/cut of medium frequencies by -12 ~ +12 dB. This parameter is shown only when EQ MID is on.	<input type="radio"/>	<input type="radio"/>	<input type="radio"/>
<b>EQ MID F</b>	EQ MID FREQUENCY*	40(Hz)~ 18(kHz) :1..0(kHz)	Adjust EQ boost/cut frequency of medium frequencies. This parameter is shown only when EQ MID is on.	<input type="radio"/>	<input type="radio"/>	
<b>EQ MID Q</b>	EQ MID Q-FACTOR*	0.1~1.0 :0.5	Adjust the Q value (width of the frequency band affected) of medium frequencies. This parameter is shown only when EQ MID is on.	<input type="radio"/>	<input type="radio"/>	
EQ LOW EQ boost for low pitch/frequency range						
<b>EQ LO G</b>	EQ LOW GAIN*	-12~ +12dB :0dB	Adjust amount of boost/cut of low frequencies by -12 ~ +12 dB. This parameter is shown only when EQ LO is on.	<input type="radio"/>	<input type="radio"/>	
<b>EQ LO F</b>	EQ LOW FREQUENCY*	40(Hz)~ 1.6(kHz) :125(Hz)	Adjust EQ boost/cut frequency of low frequencies. This parameter is shown only when EQ LO is on.	<input type="radio"/>	<input type="radio"/>	
SEND-RETURN EFFECT levels						
<b>REVERB SEND</b>	REVERB SEND LEVEL*	0~100 :0	Adjust the signal level sent from tracks to the Reverb effect.	<input type="radio"/>	<input type="radio"/>	
<b>CHORUS SEND</b>	CHORUS/ DELAY SEND LEVEL*	0~100 :0	Adjust the signal level sent from tracks to the Chorus/Delay effect.	<input type="radio"/>	<input type="radio"/>	
<b>FADER</b>	FADER	0~127 :0	Adjust the sound volume.	<input type="radio"/>	<input type="radio"/>	<input type="radio"/>
<b>ST LINK</b>	STEREO LINK	On/Off :Off	Switch on/off to set the stereo link function that connects 2 monaural tracks together. (→P.20)	<input type="radio"/>		
<b>INVERT</b>	INVERT	On/Off :Off	Set whether the phase of a track is inverted or not. Off: normal phase, ON: inverted phase.	<input type="radio"/>	<input type="radio"/>	





\*Switch parameters with asterisks (\*) On/Off using the ENTER key.

# Combine multiple tracks into 1~2 tracks

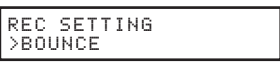

Combine multiple tracks into one monaural or stereo file.  
Using BOUNCE, this creates a new file in the same project.

## Settings for the bounced tracks PROJECT>REC SETTING>BOUNCE

### Start from the top screen.

- 1 **PROJECT**  
 Press [PROJECT].
- 2 Select >REC SETTING .  
 Change menu  
 Press [ENTER].
- 3 Select >BOUNCE .  
 Change menu  
 Press [ENTER].

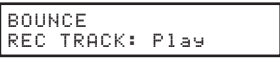
### Set whether the track that is overwritten by the bounce recording is muted or not.

- 4 Select >REC TRACK: Play.  
 
- 5  Press [ENTER].

Mute: Set the bounce destination track to be silent (initial setting).  
Play: Set the bounce destination track to play and be included in the bounce.





## NOTE

- You can cancel a bounce using the [UNDO/REDO] key.
- If you bounce 2 monaural tracks to stereo, set the PAN of the odd number track to L 100 and the even number track to R 100.

 Ref: Mix down

P.41, 44

## Bounce (preparation)

- 1 Set tracks that you want to bounce to playback.  
**PLAY/MUTE/REC** Press the [PLAY/MUTE/REC] 1-2 times until the green light turns on.  
   
 Green light on: playback enabled (PLAY)
- 2 Select destination track(s) for the bounce.  
**PLAY/MUTE/REC** Press [PLAY/MUTE/REC] 1-2 times until the red light turns on.  
   
 Red light on: record enabled [REC]

## HINT

- "Bounce" means combining audio data from several tracks and files together into one stereo or monaural file. This is also called "ping-pong recording."

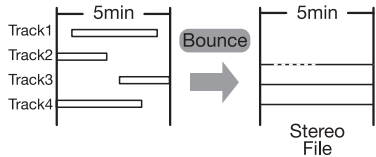

- To also record the signal of the track(s) that the bounce is being recorded to, set "REC TRACK" to "Play" in the BOUNCE Menu as described at Step 4.
- Once the bounce is executed, a new file will be created in the same project.
- If you set the bounce destination to a monaural track, the recorded signals are mixed to monaural. If set to a stereo link track pair, the recorded signals are mixed to stereo.

## Bounce (recording)

3 SWAP/BOUNCE

 Press [SWAP/BOUNCE].

4 Select >BOUNCE.

 Change menus  

 Press [ENTER].

5 Select On.

 Set On/Off 

 Press [ENTER].

BOUNCE icon appears on display





Proceed to the next step or cancel



Select OFF to exit bounce mode.

6  Press and hold [EXIT] to return to the top.

7  +  Press [REW] & [Stop] at the same time to return the counter to the head.

8  +  Press [REC] and then [PLAY] to start recording.



Red light on



Green light on

9  Press [STOP] to end the bounce.

## Adjust the mix balance (audition)

1  Press [PLAY] to start playback.

2 Adjust the mix balance including REC LEVEL, volume, PAN and EQ for each track.

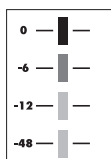

Make sure that the red (0 dB) signal does not light on the MASTER level meter.

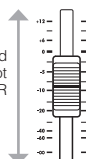

3  Press [STOP] to stop playback.

## Playback the track after bouncing

1 Press [PLAY/MUTE/REC] of the bounce destination track.

**PLAY/MUTE/REC** Press it 1-2 times until the green light turns on.





Green light on: playback enabled (PLAY)

2 Press [PLAY/MUTE/REC] on the tracks bounced.

**PLAY/MUTE/REC** Press 1-2 times each until the light turns off.



Light off: MUTE (no sound)

3  +  Press [REW] & [Stop] at the same time to return the counter to the head.

4  Press [PLAY] to start playback.

# Using a mastering effect

Use a mastering algorithm as an insert effect on the master track that affects just the mix down.

## Insert an INSERT EFFECT before the [MASTER] fader.

**1** **INSERT EFFECT**  
 Press [INSERT EFFECT].

**Effect ON/OFF switch**  
 If "INSERT EFFECT OFF" is displayed, press [ENTER].

**2** **Select MASTERING.**  
 CLEAN <IN1>  
 No.00:Standard  
 Change algorithms

**3** **Select MASTERING.**  
 MASTERING <IN1/2>  
 No.00:PlusAlfa  
 Change menus

**4** **Select >INPUT SOURCE.**  
 No.00:Plus Alfa  
 >EDIT  
 Change menus

**5** **Select MASTER.**  
 No.00:Plus Alfa  
 >INPUT SOURCE  
 Press [ENTER].  
 Input Source  
 INPUT1  
 Change input

**6** **Select MASTER.**  
 Input Source  
 MASTER  
 Press [ENTER].  
 No.00:Plus Alfa  
 >EDIT  
 Change menus

**7** **Select the patch.**  
 MASTERING <MASTER>  
 No.03:DiscoMst  
 Change patch

**8** **Press [EXIT].**  
 PRJ001 <MASTER>  
 000 000:00:000

## 7 Select the patch.

MASTERING <MASTER>  
 No.03:DiscoMst

Audition the patches while listening to the tracks playback, and then select one.

PLAY STOP  
 



## 8 Press [EXIT].

PRJ001 <MASTER>  
 000 000:00:000

## NOTE

- If the INSERT EFFECT is applied to the [MASTER] fader, you cannot also use the INSERT EFFECT on track inputs.
- At step 7, if you notice any distortion of the signals because of the MASTERING EFFECT, check the sound of playback on the track and adjust it by lowering all the faders. (If a track sound is distorted, adjust that track.)
- You can select STEREO, DUAL, MIC or MASTER algorithms. If you set another algorithm, the insert position changes to the inputs.

## HINT

- When you choose a MASTERING algorithm, you can use the MASTERING EFFECT processing on the stereo mix.

Recording signal flow to the master track

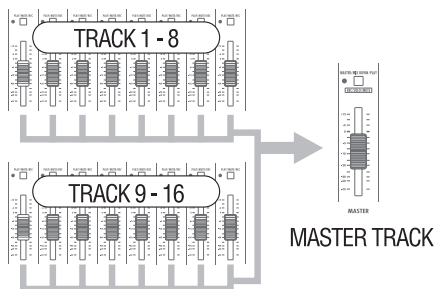



# Recording to the master track

Record a "final" stereo mix as a mix down on the [MASTER] track. Signals are recorded to the [MASTER] track after passing through the [MASTER] fader.

## Recording to the [MASTER] track.

Preparation: Adjust the signal levels.

**1**

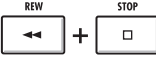

Press [REW] + [STOP] at the same time and then [PLAY] to start playback from the top.

**2**

Adjust the level of the signal that passes through the master fader.

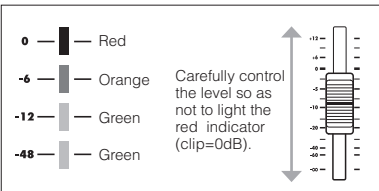

**3**



Press [STOP].

Recording to the master track

**4**



Press [MASTER/MIX DOWN/PLAY] 1-2 times until the red light turns on.

**5**



Press [REW] & [Stop] at the same time to return the counter to the head.

**6**



Press [REC] and [PLAY] in turn to start recording.

**7**



Press [STOP] to stop recording.

Play the master track

**1**



Press [MASTER/MIX DOWN/PLAY] 1-2 times until the green light turns on.

Green light on: playback enabled  
Doing this mutes the other tracks and disables all effects.

**2**

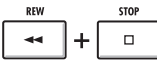

Press [REW] & [Stop] at the same time to return the counter to the head.

Press [PLAY] to start playback.

**3**



Press [STOP] to stop playback.

Disable master track playback.

**4**



Press [MASTER/MIX DOWN/PLAY] 1-2 times until the light turns off.

Muting of the other tracks is canceled and their status lights become as they were before enabling master track playback.

## HINT

- Each project can have one master track.
- The master track will have a file assigned.
- You can even mix down from the middle of a song, overwriting the data of the recorded section.
- During recording you can confirm the playback levels of each track and the recording levels of the master track.
- The signals sent from the OUTPUT jacks are the same signals that have passed through the [MASTER] fader.
- You can use the [UNDO/REDO] key.
- You can use the metronome during playback.

## NOTE

The settings of the pan/balance, insert and send/return effects of each track affect the signals sent to the master track and are reflected in its sound.



Consecutive playback of multiple master tracks.

No.65

# Entering names

You can change names when you create new data, use RENAME menu functions or edit patches. Whatever name change method you use, the handling of letter positions and letters is the same.

## Keys used for name changes



- 1** Select a letter.

PRJ001

When a letter in a name is highlighted, you can change it.
- 2** Change the initial letter.

QPRJ001

Insert and select letter
- 3** Choose the second letter to be changed.

QPRJ001

Move letter position
- 4** Change the second letter.

Q5PRJ001

Insert and select letter
- 5** Delete the third letter.

Q5PRJ001

Letter deletion

Q5RJ001
- 6** Choose the last letter and change.

Q518\_0

**7** Proceed to the next action  
 or  
 exit without saving the change.

## Names and rules

Project	Usable characters
Project number PRJ xxx: PRJ (space, 3 numerals) The project number is given automatically starting with the lowest and is not changeable.	None
Project name PRJxxx: PRJ, 3 numerals, Maximum of 8 characters	Numerals: 0-9 Alphabet: A-Z, a-z Symbols: (space) ! * # \$ % & ' ( ) * + , - . / : ; <> = ? @ [ ] ^ _ ' {   }

File (recorded)	Usable characters
<b>Monaural files</b> MONO-xxx.WAV MONO-, 3 numerals (x), extension (.WAV)	Maximum of 8 characters + .WAV (extension)
<b>Stereo files</b> STE-xxx.WAV STE-, 3 numerals, extension (.WAV)	
<b>Mix Down (Master)</b> "MASTRxxx.WAV" MASTR, 3 numerals, extension (.WAV)	Numerals: 0-9, Alphabet: A - Z, Symbol: _ (under score)

Insert effect/Send-Return effect	Usable characters
Patch number: 2 numerals. The patch number is given automatically starting with the lowest and is not changeable.	None
Patch name: 8 characters.	Numerals: 0-9 Alphabet: A-Z Symbols: (space) ! * # \$ % & ' ( ) * + , - . / : ; < > = ? @ [ ] ^ _ ' {   }

## NOTE

- When a name is displayed and the initial letter is highlighted during operation, you can change the name.
- If the same name exists, a \* symbol will be attached to the top of the name. You have to change the name to save it.
- Deleted letters cannot be retrieved. You can restart the procedure with the EXIT key.
- If you have mistakenly changed a patch name, move to the next patch without saving.
- The numbers "xxx" of a name are automatically assigned at naming time.

# Error list: what to do when these messages appear on the screen

Push the [EXIT] key when you see a message like “---Error” or “Please push the EXIT key.”  
When other errors and messages occur, the displayed screen will automatically close within three seconds.

Message	Meaning	Response
Message when something is missing.		
No Card	There is no card inserted.	Make sure that an SD card is inserted correctly.
No Project	There is no project at all.	Check that the project has not been deleted or changed to a different place.
No File	There is no file in the project.	Check that the file has not been deleted or stored in a different place.
No USB Device	There is no USB connection.	The connection may have been canceled or there may be problems with the cable.

Messages shown frequently		
Reset DATE/TIME	Setting lost because of low battery.	Set the [DATE/TIME] again. →P.14
Low Battery!	Time to change the batteries.	Change batteries or connect the adapter.
Stop Recorder	Cannot be accessed during playback/recording.	Stop the recorder first, and then try again.

Messages that objects (projects, files, etc) are protected		
Card Protected	SD card is protected.	Eject the SD card and unlock the write protection. Insert the card again. →P.12
Project Protected	The project is protected.	Disable project protection using the [PROTECT] menu. →P.56
File Protected	This is a read-only file, you cannot write to it.	Disable the read-only status of the file using a computer.
USB Device Protected	USB device connection is protected.	Disable the protection of the equipment.

Over capacity or over limit messages		
Card Full	The card is full.	Change to a new card or delete unneeded data.
Project Full	No more projects can be saved on the card.	Delete unneeded projects.
File Full	File is full.	Delete unneeded files.
USB Device Full	The connected USB device is full.	Change the connected USB device or delete data.

No access messages		
Card Access Error	Unable to read or write the card.	Press EXIT and try the operation again.
Project Access Error	Unable to read or write the project.	Press EXIT and try the operation again.
File Access Error	Unable to read and write the file.	Press EXIT and try the operation again.
USB Device Access Error	Unable to read or write to the connected USB device.	Press EXIT and try the operation again.
Card Format Error	This is a card format the R16 cannot use.	Change the card format to one that the R16 can use.
File Format Error	This is the file format the R16 cannot use.	Change the file format to one that the R16 can use.
USB Device Format Error	This is a USB format the R16 cannot use	Change the USB format to one that the R16 can use.

Other errors		
Card Error	There is an error occurring.	Press EXIT and try the operation again.
Project Error		
File Error		
USB Device Error		

# Effect patch overview

You can select patches in the R16, use effects easily, make fine adjustments to suit the music, and then edit and save patches.

## Effect patch use process

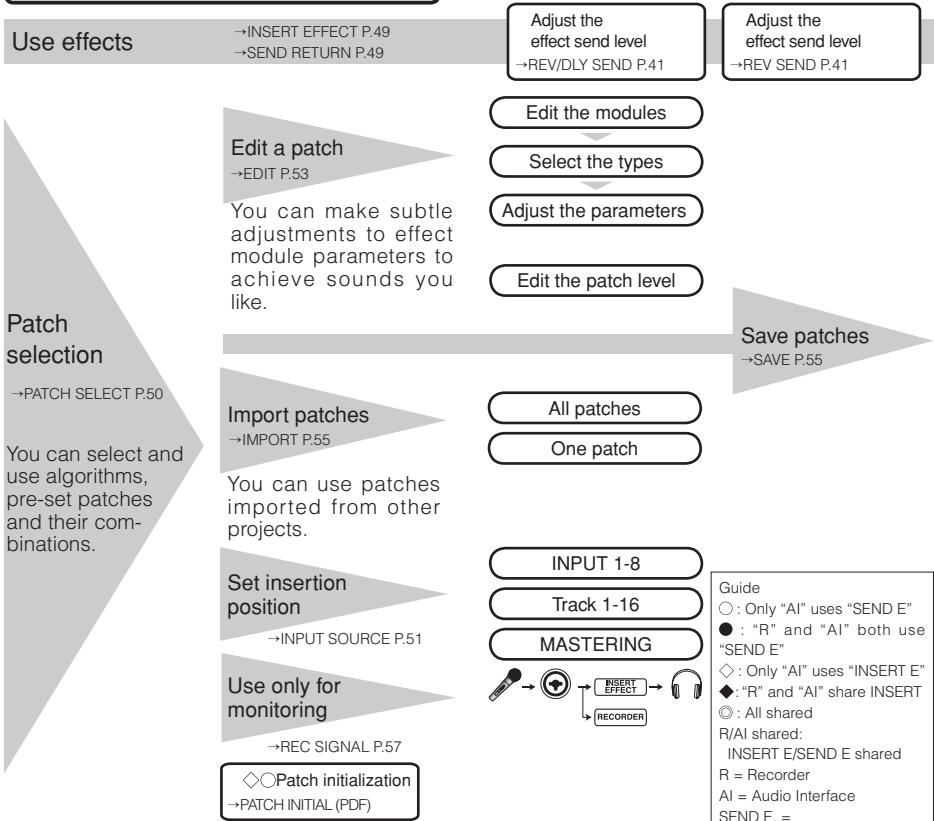

## Algorithms and patches

One effect is called an "effect module" and it consists of 2 elements.

Effect types, which are different types, and effect parameters, which control the depth of the effect.

A patch is the result of adjusting the effect type and parameters of each module.

An algorithm is the orderly arrangement of the initial patches arranged for recording targets or methods.

### Algorithms

CLEAN	DISTORTION
ACO/BASS SIM	BASS

### Patch



### Module

	MODULATION/DELAY			
Effect types	CHORUS	ENSEMBLE	FLANGER	
Parameters	Depth Rate Tone Mix	Depth Rate Tone Mix	Depth Rate Resonance Manual	

### Insert effects and send return effects

The insert effects in one project include 330 patches classified into 9 algorithms. You can select the algorithms and patches according to your application and choose where to insert those patches.

The send/return effect is internally connected in the SEND/RETURN at the MIXER section. There are 2 types of effects adjustable by their mixer SEND LEVELS (signal volumes sent to the effect) and they can be used together.

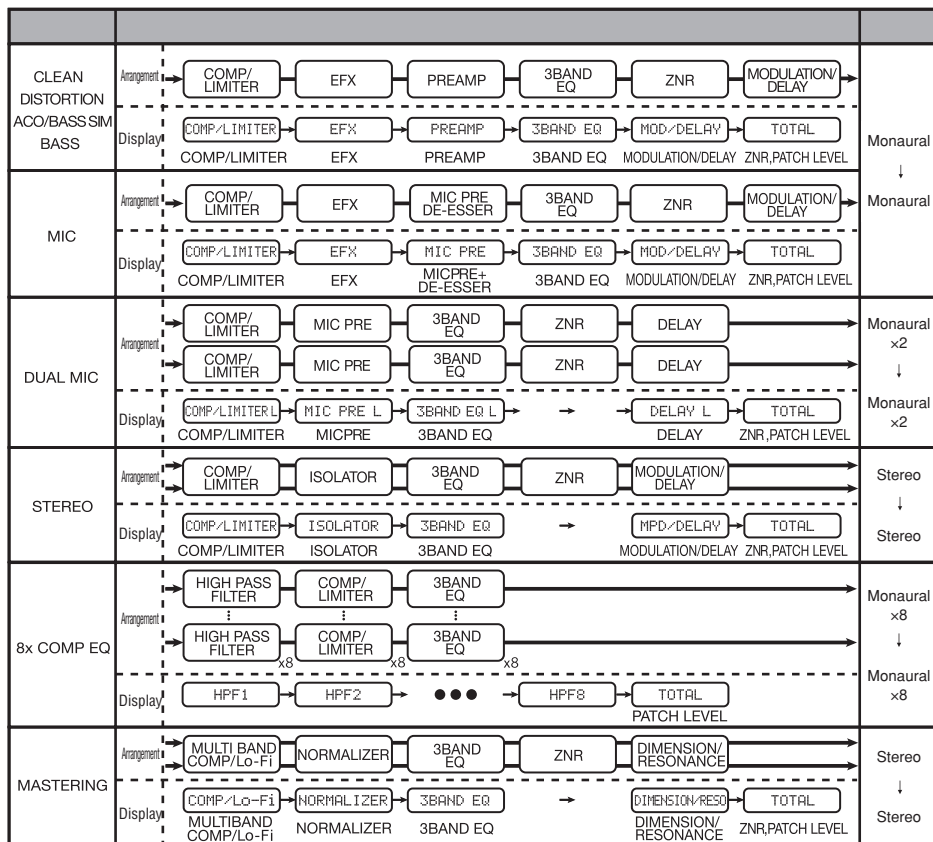

# Input/output of the insert and send return effects

There are 2 types of effects processors built in to the R16—insert effects and send return effects. You can use them at the same time.

Insert effect/send return effect

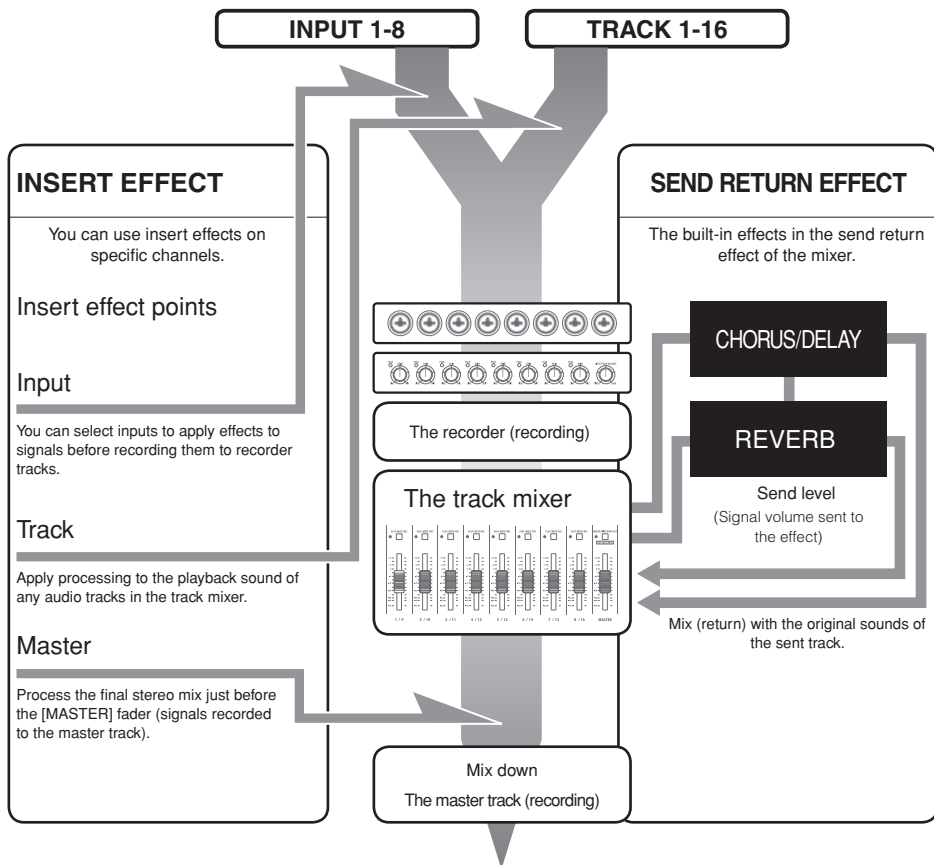

### Insert effect signal flow

Put the insert effect on a monaural input and output in monaural.



### Send return effect signal flow

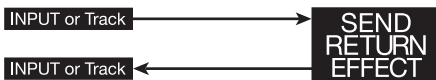

Ref.: Insert effect position P.52

## Uses of effects and patches

Insert effects and send return effects are selected and adjusted the same way.

You can select the most appropriate modules from the algorithms, edit types and parameters and use saved patches.

There are a few major differences between the two types of effects when making settings. For an INSERT EFFECT, you select a patch and set the insertion point. For a SEND RETURN EFFECT, you adjust the send level of the signals using the mixer.

Other functions are "IMPORT" to get patches from another project and "REC SIGNAL" to apply the effect only to monitoring.

The use procedures of effects are the same when using the R16 as an audio interface and control surface, but the patches are initialized when the unit is not used as a recorder.

### INSERT EFFECT

Algorithm name on display	Number of patches (programmed patches)
▼Algorithm suitable for guitar/bass recording	
CLEAN	30(22)
DISTORTION	50(40)
ACO/BASS SIM	20(10)
BASS	30(20)
▼For microphone recording, such as vocals	
MIC	50(30)
▼For 2 independent channels (2 mono inputs/outputs)	
DUAL MIC	50(30)
▼ For recording synthesizers, electric pianos and other line-output instruments	
STEREO	50(40)
▼ Algorithm with 8 independent channels of input/output	
8×COMP EQ	20(10)
▼ Processing for final stereo mixes	
MASTERING	30(21)

### SEND RETURN EFFECT

Algorithm name on display	Number of patches (programmed patches)
▼ Process final stereo mix signals	
CHORUS/DELAY	30(18)
▼ Process final stereo mix signals	
REVERB	30(22)

## Select effect & patch

**Effect** <INSERT EFFECT>  
<SEND EFFECT>

1 Press until the red light turns on.



2 **INSERT EFFECT** or **SEND RETURN EFFECT**



Press [ENTER] to turn on/off.



3 Select the algorithm.

Algorithm name  
Patch number: Patch name

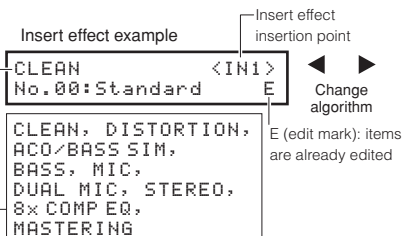

CHORUS/DELAY  
REVERB

Send return effect example

SEND CHORUS/DELAY  
No.00:ShortDLV

4 Select the patch.

CLEAN <IN1>  
No.15:Standard E



Press [▼].

- ▶ EDIT
- ▶ IMPORT
- ▶ INPUT SOURCE
- ▶ REC SIGNAL
- P.53
- P.55
- P.51
- P.57

# Insert effect insertion position

You can change the insert position of the Insert Effect.  
This menu is only for Insert Effect.

**1** **INSERT EFFECT**

 Press [INSERT EFFECT].

**Effect on/off switch.**

 If "INSERT EFFECT OFF" is displayed, press [ENTER].

**2** Select the algorithm/patch.

Current insert position

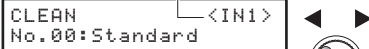

 Change algorithm

 Change patch

<b>IN**</b>	Inserted in INPUT **
<b>IN**/**</b>	Inserted in INPUTS ** and **
<b>TR**</b>	Inserted in TRACK **
<b>TR**/**</b>	Inserted in TRACKS ** and **
<b>IN*~**</b>	Inserted in INPUTS * to **
<b>TR*~**</b>	Inserted in TRACKS * to **
<b>MASTER</b>	Inserted in the master track

**3**  Press [▼].

## NOTE

- You can select a single INPUT (1~8) only when you have chosen the CLEAN, DISTORTION, ACO/BASS SIM, BASS or MIC algorithm.
- You can select Track 1-8 or Track 9-16 only when the 8 x COMP EQ is chosen as the algorithm.
- INPUT 1-8 can be selected only when the 8 x COMP EQ algorithm has been chosen.
- After you select an insertion place, if you change the algorithm to 8 x COMP EQ, the insertion place will be changed to Input 1-8, Track 1-8 or Track 9-16 (depending on the previous setting).
- To insert into a single monaural track output, you must select TRACK 1 ~ TRACK 8. To insert into a two monaural tracks or a stereo track, you must select TRACK 1/2 ~ TRACK 15/16. If you want to insert before the MASTER FADER, you must select MASTER.

**4** Select >INPUT SOURCE .



 Change menu

 Press [ENTER].

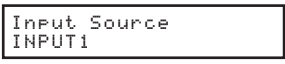

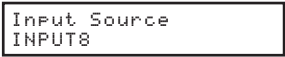

 Change input place

**5** Set source of input into effect.

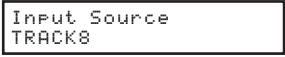

 Change input place



 Press [ENTER].

On display	Insert place
<b>Input</b>	Mixer input
<b>Input1-Input8</b>	Single mixer input
<b>Track1,Track2</b>	Output from either monaural track 1 or 2
<b>Track1/2, Track3/4</b>	Output from either stereo track or 2 monaural tracks
<b>Master</b>	Just before the [MASTER] fader
With 8 x Comp EQ setting case	
<b>Track1-8</b>	All track 1-8 outputs
<b>Track9-16</b>	All track 9-16 outputs

**6**  Press [▲].

Current insert position



## HINT

### Change the insertion place of the insert effect.

When a project is at the default status, the insert effect is inserted on INPUT 1.

To change this place, select an INPUT SOURCE at Step 4:



**Insert position of insert effect**

Inserting the INSERT EFFECT into 2 monaural inputs  
(DUAL algorithm)

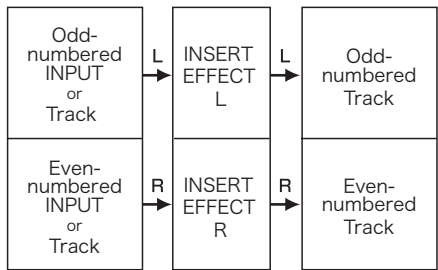

Inserting an INSERT EFFECT into a stereo input  
(Stereo Master algorithm)

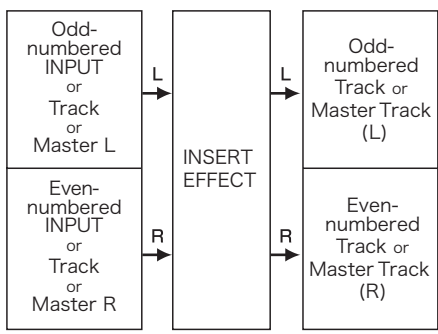

Inserting an INSERT EFFECT on 8 inputs  
(8 x COMP EQ algorithm)

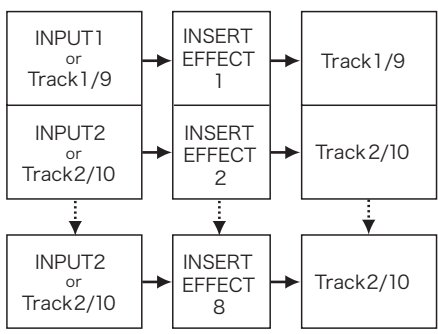

## Insert effect Send return effect : Patch editing

You can create patches that combine effects together, change effect types in patches, or change processing however you like by adjusting the depth of effects using their parameters.

**1** **INSERT EFFECT**  **or** **SEND RETURN EFFECT**  Press [INSERT EFFECT] or [SEND RETURN EFFECT].

**Effect on/off switch.**

**INSERT EFFECT**  If "INSERT EFFECT Off" is displayed, press [ENTER].

**2** Select the algorithm/patch.

CLEAN <IN1>  
No.15:Standard E

Change algorithm

**3** Press [▼]. Change patch

**4** Select >EDIT .

No.15:Standard  
>EDIT E

Change item

Press [ENTER].

### HINT

- Some patches say "Empty," because no modules in the patch have been set yet.
- When you want to edit the ZNR module, go to the page with "TOTAL" in the first row.
- You can individually edit the modules arranged in the L/R Channels of the DUAL MIC ALGORITHM. Your selection is the left channel when the first row displays "L" and the right channel when the first row displays "R."
- In the 8 x COMP EQ ALGORITHM, each channel has its own HPF, COMPRESSOR and EQ modules and you can turn each effect module on/off on each channel independently. You can check the current channel by looking at the number in the first row of the display.

### Edit effect modules

**5** Turn the effect types on/off.

Effect module off

Compressor  
Off

Press [ENTER] to switch.

Type (effect module) ON

COMP/LIMITER E  
Compressor

E: Edit mark  
Shown after you edit or change

Effect type

### Set the effect module

**6** Select the effect module.

COMP/LIMITER E  
Compressor

MOD/DELAY E  
Chorus

Change module

Effect type

### Edit the patch level (final patch sound volume)

**7** Set the patch level.



TOTAL  
Patch Level=25

Change module



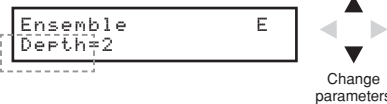
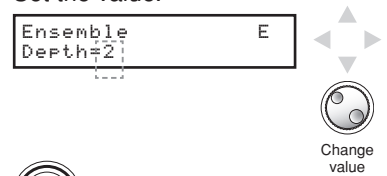

Change value

**8** Press [EXIT] to return.

### Adjust the effect parameters

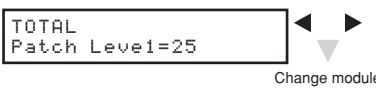
- 1 Select a parameter.
 
- 2 Set the value.
 
- 3  Press [EXIT] to return.

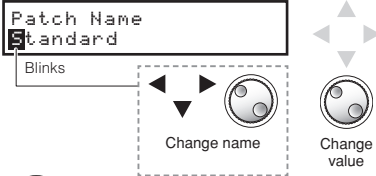
### Change INSERT EFFECT name

- 1 Select TOTAL .
 
- 2 Press [▼] until you see PATCH NAME.
 

- 3  Press [EXIT] to finish.

### NOTE

- You cannot edit an algorithm itself, including the combination and arrangement of the effect modules.
- If you turn "off" an effect module, all the settings after the effect module, such as the type and parameters will also be turned off.
- When you are using 8 x COMP EQ, you cannot turn an effect on or off for all channels at once. But if you press [ENTER] when an effect setting value is displayed for the desired channel, you can switch it off for that channel.
- You cannot turn off the "TOTAL" modules.
- There is no ZNR module in the 8 x COMP EQ algorithm.
- If you change to another patch without saving a patch that shows the 'E' mark, your edits will be lost completely. Please refer to the next page for patch saving.

### Change SEND RETURN EFFECT name

- 1 Press [▼] until you see PATCH NAME.
 

- 2  Press [EXIT] to finish.

## Insert effect Send return effect : Patch save

Once you have edited a patch, use “SAVE” to save it. You can save a patch at any place within the same algorithm.

- 1** **INSERT EFFECT**  **or** **SEND RETURN EFFECT**  Press [INSERT EFFECT] or [SEND RETURN EFFECT].



**Effect ON/OFF switch**

When "INSERT EFFECT Off" is displayed, press [ENTER].



- 2** Select the algorithm/patch. Change algorithm

CLEAN <IN1>  
No.15:Standard E

Patch has been edited

 Change patch
- 3**  Press [▼].
- 4** Select >SAVE . Change menu

No.00:Standard  
>SAVE

 Press [ENTER].
- 5** Select the place to save. Change place to save

Save to  
NO.29:Empty

Save location number: patch name

 Press [ENTER].
- 6** Execute [SAVE] action.

NO.29:Empty  
Save?

 Press [ENTER].

### NOTE

- These procedures are the same for both insert and send return effects.
- If you switch to another patch without saving an edited patch, you will lose all the edits. Remember to always save your edited patches.
- The import source and the import destination are different projects when using PATCH IMPORT.

### HINT

- You can save your edited patch at any place within the same algorithm.
- You can make a patch copy by saving an existing patch to a different area.

# Insert effect

## Send return effect : Patch import

Import one or all patches that have been created in another project to use in the current project.

See steps 1~3 on the previous page.

**4** Select **>IMPORT .**

`No.00:Standard`  
`>IMPORT`

Change menu

Press [ENTER].

**5** Change menu. Select import method.

`PATCH IMPORT`  
`>ALL`

Change menu/item

Change menu>ALL: import all patches from the target project  
Change menu>PATCH: select one patch and import it from the target project

### Import all patches.

#### IMPORT>ALL

**1** Select **>ALL .**

`PATCH IMPORT`  
`>ALL`

Change item

Press [ENTER].

**2** Select the project to import from.

`ALL PATCH IMPORT`  
`No.001:PRJ001`

Source project number and name

Change project

Press [ENTER].

**3** Confirm the project to import from and press [IMPORT].

`No.001 : PRJ001`  
`All Patch Import?`

Press [ENTER].

### Import one patch.

#### IMPORT>PATCH

**1** Select **>PATCH .**

`PATCH IMPORT`  
`>PATCH`

Change item

Press [ENTER].

**2** Select the project to import from.

`PATCH IMPORT`  
`No.001:PRJ001`

Source project number and name

Change project

Press [ENTER].

**3** Select the patch to import.

`Import`  
`No.00:Standard`

Source patch number

Change patch

Press [ENTER].

**4** Select the patch to import.

`Import to`  
`No.00:Standard`

Destination patch number (save location)

Change place to save

Press [ENTER].

**5** Import the patch.

`NO.01:Ensemble`  
`Import?`



Press [ENTER].

# Using the insert effect only for monitoring

By applying an insert effect only to monitoring, unaffected input signals can be recorded to tracks.

**1** **INSERT EFFECT**  
 Press [INSERT EFFECT].

**Effect ON/OFF switch**  
 When "INSERT EFFECT Off" is displayed, press [ENTER].

**2** Select the Algorithm/Patch.  
 Change algorithm  
 Change patch

**3**  Press [▼].

## Using the insert effect only for monitoring

By default, when an insert effect is applied to an input signal, the signal with the effect is recorded to the track. However, when desired, you can apply the insert effect only to the monitoring outputs and record the non-processed input signal on the track.

For example, you can apply an insert effect to a microphone, to make a vocalist feel more comfortable singing, but still record the vocal without the effect.

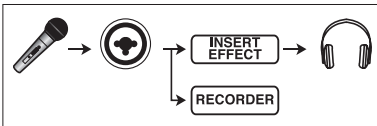

**4** Select >REC SIGNAL .

No. 00: Standard  
>REC SIGNAL

 Press [ENTER].

**5** Select DRY .

REC SIGNAL  
Dry

Change setting



 Press [ENTER].

<b>WET</b> (Default value)	The input signal will be recorded to the track after it passes through the insert effect.
<b>DRY</b>	The input signal will be recorded to the track before passing through the insert effect. However, the input signal monitored from the OUTPUT and PHONES jacks will pass through the insert effect first.

## HINT

- The settings made here will be stored project by project.
- If necessary, restore the initial "Wet" setting before recording other parts.

## Project overview & project protection

A project stores data and elements necessary for music playback. The “PROTECT” function allows you to prevent the alteration of a completed project.

All elements of a piece of music are stored in a project as one unit, including audio files, information about track assignments, and mixer, effect, metronome and tuner settings.

The unit can handle a maximum of 1000 projects on a single card. Create a new project for each new piece of music.

Data saved in a project:

- \* Audio data for every track including the MASTER track
- \* Folder settings selected by tracks
- \* Mixer settings
- \* Patch numbers and patch contents set for insert and send return effects
- \* Contents of play lists
- \* All other necessary files

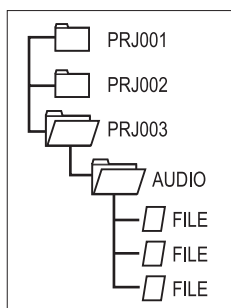

### Protecting a project PROJECT>EDIT>PROTECT

- 1 **PROJECT**  
 Press [PROJECT].
- 2 Select >EDIT .  

PROJECT  
>EDIT

Change menu  
 Press [ENTER].
- 3 Select >PROTECT .  

PROJECT EDIT  
>PROTECT

Change menu  
 Press [ENTER].
- 4 Select >ON .  

PROJECT PROTECT  
On

Turn ON/OFF  
 Press [ENTER].

### NOTE

- You can play back a project when it is protected, but you cannot change it. If you want to record in it or edit it again, set “PROTECT” to “Off.”
- Projects that are not protected will be automatically saved to the SD card when you turn the POWER switch OFF or when you open another project.
- We strongly recommend setting “PROTECT” to “On” once you complete a piece of music to avoid saving a mistaken operation later.

### HINT

- The lock icon appears on the screen when a project is protected.



# Create a new project

With the R16 you can create up to 1000 projects on a single card. You can also transfer the settings of the previous project to a new project.

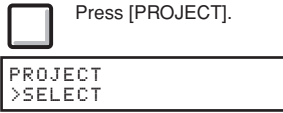
- 1** **PROJECT**  
 Press [PROJECT].

PROJECT  
 >SELECT

Change menu
- 2** Select >NEW.

PROJECT  
 >NEW [SD]003:22:52]

Change menu

 Press [ENTER].
- 3** Confirm the project name.

New project number

Project No.003  
 PRJ003

Blinks

New project name

Change the name to be saved

 Press [ENTER].
- 4** Select whether to use the settings from the last project.

SETTING?  
 [CONTINUE] RESET

Change menu

Select to use default settings

 Press [ENTER].
- 5** Create the project.

No.003:PRJ003  
 Create?

 Press [ENTER].

## NOTE

You can use the settings and values of the last project in the new one or use the R16 default settings.

### Settings carried over with CONTINUE

- BIT LENGTH setting
- INSERT EFFECT settings
- SEND RETURN EFFECT settings
- Track status (PLAY/MUTE/REC) settings
- BOUNCE settings
- REC TRACK settings
- Track parameter settings
- METRONOME settings

### [RESET]

Use default setting values for every item

## HINT

At Step 3, you can change the name of the new project.

 Ref.: Changing names

P.43











## Selecting projects and files

You can select a project for recording, playback and editing from the top screen.

You can also select files for playback and assign them to tracks.

### Select a project

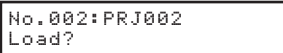
PROJECT>SELECT

- 1** **PROJECT**  
 Press [PROJECT].
- 2** Select >SELECT .  
 Change menu  
 Press [ENTER].
- 3** Select the project.  
  Change project  
 Press [ENTER].
- 4** Load the project.  
  Press [ENTER].

### NOTE





You can only playback and record to the project that is currently loaded. You cannot load and use multiple projects at the same time.

### HINT





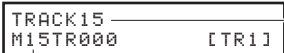

When the R16 [POWER] switch is turned ON, the project loaded the last time the unit was used will be loaded automatically. (If you have changed SD cards, then the last project used on the inserted card will be loaded.)

### Select a file

PROJECT>FILE

- 1** **PROJECT**  
 Press [PROJECT].
- 2** Select >FILE .  
 Change menu  
 Press [ENTER].
- 3** Select the file.  
 Change track  
 Select file.  
 or use [1 - 8] and [MASTER] status keys



\*If you want to listen to a file for confirmation, you can use the following keys.

	Playback: [PLAY] key
	Stop: [STOP] key
	Fast forward: [FF] key
	Rewind: [REW] key
	Zero return: [STOP] and [REW] keys
	Moving to a marker: [>>] and [<<] MARKER keys

# Project and file information

You can display information about the currently loaded project and files including creation dates and times, capacities, recording lengths and file formats.

## Project information PROJECT>INFORMATION

- PROJECT**  
 Press [PROJECT].
- Select **>INFORMATION**.  
 Change menu  
 Press [ENTER].

- Select the type of information.

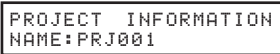
**NAME**  Project name

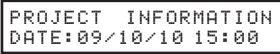
**DATE**  Year/month/day/time of creation

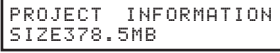
**SIZE**  Size

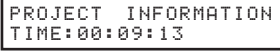





**TIME**  Length of project recording

Change item

### HINT

- Project and file INFORMATION pages can only be viewed. Their contents cannot be edited directly.

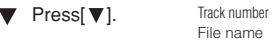
## File information PROJECT>FILE>INFORMATION

- PROJECT**  
 Press [PROJECT].
- Select **>FILE**.  
 Change menu  
 Press [ENTER].
- Select track number (1–16, MASTER) and file name.  
 Change track  
 Press[▼].
- Select **>INFORMATION**.  
 Change file  
 Press [ENTER].

- Select the types of information.

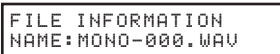
**NAME**  File name

**DATE**  Year/month/day of the creation

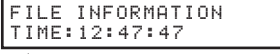
**TIME**  Time of creation

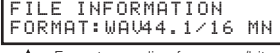
**FORMAT**  Change item  
 ▲ Format, sampling frequency/bit rate, ST (stereo), MN (monaural)  
 ▼

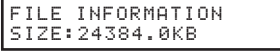
**SIZE**  Size

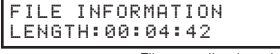
**LENGTH**  File recording length

## Copying projects and files

You can copy a saved project and use it as a new project.

You can make copies of files in the same project by changing the file names.

### Project copy

PROJECT>EDIT>COPY

- 1 **PROJECT**  
 Press [PROJECT].
- 2 Select >EDIT.  

PROJECT  
>EDIT

 Change menu  
   
 Press [ENTER].
- 3 Select >COPY.  

PROJECT  
>COPY

 Change menu  
   
 Press [ENTER].
- 4 Select the project to copy.  

PROJECT COPY  
No.002:PRJ002

  
 Press [ENTER].
- 5 The new project number of the copy is shown.  

Copy to  
No.011

  
 Press [ENTER].
- 6 Copy the project.  

No.002->No.011  
Copy?

  
 Press [ENTER]. Old->new project numbers

### File copy

PROJECT>FILE>EDIT>COPY

- 1 **PROJECT**  
 Press [PROJECT].
- 2 Select >FILE.  

PROJECT  
>FILE

 Change menu  
   
 Press [ENTER].
- 3 Select the file to copy.  

TRACK 1  
VOCAL.WAV

  
 Press[▼].
- 4 Select >EDIT.  

VOCAL.WAV  
>EDIT

 Change menu  
   
 Press [ENTER].
- 5 Select >COPY.  

VOCAL.WAV  
>COPY

 Change menu  
   
 Press [ENTER].
- 6 Change the name of the copied file.  

FILE COPY  
VOCAL.WAV

Change saved file name of the copy

  
 Press [ENTER].
- 7 Copy the file.  

XOCAL.WAV  
Copy?

  
 Press [ENTER].

## NOTE







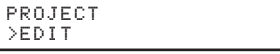

- When there is a project with the same name, a \* will be added to the top. Change the name and save.

# Renaming files and projects

Change the name of the currently loaded project and files.

## Project name change

PROJECT>EDIT>RENAME

- 1  Press [PROJECT].
- 2 Select >EDIT.  
 Change menu  
 Press [ENTER].
- 3 Select >RENAME.  
 Delete character  
 Press [PROJECT].
- 4 Change characters.  
 Delete character  
 Change position  
 Selected character highlighted and blinking  
 Change character  
 Press [ENTER].

### NOTE

- If there is a project with the same name, a \* mark will be added to the top. Change the name and save.

### HINT

#### Project names











Characters that can be used: 8 maximum  
 Numerals: 0-9  
 Alphabet: A-Z, a-z  
 Symbols: (space) ! " # \$ % & ' .....etc.

#### File names

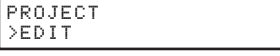
Characters that can be used: 12 including extension  
 Numerals: 0-9  
 Alphabet: A-Z (capital letters)  
 Symbol: \_ (underscore)

## File name change

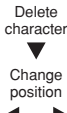
PROJECT>FILE>EDIT>RENAME

- 1  Press [PROJECT].
- 2 Select >FILE.  
 Change menu  
 Press [ENTER].
- 3 Select the file name.  
 Change track  
 Press [▼]  
 Change file
- 4 Select >EDIT.  
 Change menu  
 Press [ENTER].
- 5 Select >RENAME.  
 Change menu  
 Press [ENTER].
- 6 Select >RENAME.  
 Delete character  
 Change position  
 Selected character highlighted and blinking  
 Change character  
 Press [ENTER].

# Deleting files and projects

Delete selected files and projects.

## Delete a project

PROJECT>EDIT>DELETE

- 1 **PROJECT**  
 Press [PROJECT].
- 2 Select >EDIT.  

PROJECT  
>EDIT

 Change menu  
 Press [ENTER].
- 3 Select >DELETE.  

PROJECT  
>DELETE

 Change menu  
 Press [ENTER].
- 4 Select the project to delete.  

PROJECT DELETE  
No.001:PRJ001

 Change project  
 Press [ENTER].
- 5 Delete the project.  

No.001:PRJ001  
Delete?

  
 Press [ENTER].

## Delete a file

PROJECT>FILE>EDIT>DELETE

- 1 **PROJECT**  
 Press [PROJECT].
- 2 Select >FILE.  

PROJECT  
>FILE

 Change menu  
 Press [ENTER].
- 3 Select the file name.  

TRACK1  
MONO-000 [TR7]

 Change track  
 Press [▼]  
 Change file
- 4 Select >EDIT.  

MONO-000.WAV  
>EDIT

 Change menu  
 Press [ENTER].
- 5 Select >DELETE.  

MONO-000.WAV  
>DELETE

 Change menu  
 Press [ENTER].
- 6 Delete.  

MONO-000.WAV  
Delete?

  
 Press [ENTER].

### NOTE











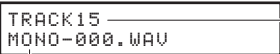

- Once deleted, projects and files cannot be retrieved. Please be careful when deleting.
- You cannot delete projects or files that have PROTECT set to ON.
- If you delete the currently loaded project, the project with the lowest number will be loaded.

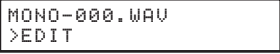
### NOTE

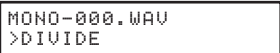
- When you delete files, the tracks they are assigned to become empty.

# Dividing files

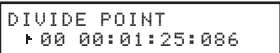
You can divide a file at any point to make two files. Do this to delete unnecessary portions of recordings or to divide long recordings.







- 1 **PROJECT**  
 Press [PROJECT].
- 2 Select >FILE.  
 Change menu  
 Press [ENTER].
- 3 Select a file.  
 Change track  
 Select file  
 or use [1-8] and [MASTER] status keys
- 4  Press [▼].
- 5 Select >EDIT.  
 Change track  
 Press [ENTER].
- 6 Select >DIVIDE.  
 Change track  
 Press [ENTER].
- 7 Set the divide point.  
 Change numbers  
 Use markers or change time   
  
 Press [ENTER].

## 8 Divide.

MONO-000.WAV  
Divide?

 Press [ENTER].

When you set the dividing point, you can use the following keys to listen to the file.











	Playback: [PLAY] key
	Stop: [STOP] key
	Fast forward: [FF] key
	Rewind: [REW] key
	Zero return: [STOP] and [REW] keys
	Move to markers: [>>] and [<<] MARKER keys

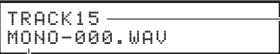

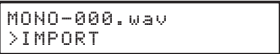

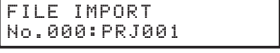
## HINT

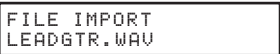
- When a file is divided, files with new names will be created automatically in the same folder. "A" is added to the end of the name of the file created from the part before the dividing point. "B" is added to the end of the name of the file created from the part after the dividing point. If the original file name already had 8 characters, the last character will be replaced with "A" and "B" in the new file names.
- The original divided file is deleted.

# Import files from other projects

Import files from projects other than the current project.

- 1 **PROJECT**  
 Press [PROJECT].
- 2 Select >FILE.  
 Change menu  
 Press [ENTER].
- 3 Select a file.  
 Change track  
 Select file  
 or use [1-8] and [MASTER] status keys
- 4  Press [▼].
- 5 Select >IMPORT.  
 Change menu  
 Press [ENTER].
- 6 Select the project that has the file to be imported.  
 Change project  
 Press [ENTER].
- 7 Select the file to import.  
   
 Press [ENTER].

- 6 Confirm the file.  
 Cursor blinks  
 Press [ENTER].
- 7 Import the file.  
  Press [ENTER].

## NOTE

- If there is a file with the same name in the project, a \* mark will be added to the top. Change the name and save.

## HINT

- Characters that can be used: 12 maximum  
 Numerals: 0-9  
 Alphabet: A-Z (Capital letters)  
 Signs: \_ (underscore)

# Sequential playback of projects

The playback order of multiple projects can be registered and managed in playlists. This is useful for playing back several songs consecutively, live play accompaniment and output to an external recorder.

## Play a playlist

- PROJECT**

Press [PROJECT].

PROJECT  
>SELECT

Change menu
- Select >SEQUENCE PLAY.

PROJECT  
>SEQUENCE PLAY

(ENTER) Press [ENTER].
- Select the playlist.

"Empty": no songs in list

List1:Empty  
Total 00:00:00:000

Number of registered projects shown

List1:2Songs  
Total 00:03:16:186

Playlist number      Number of projects  
Total playback time of list

Select list
- PLAY**

Press [PLAY].

Display during playback      Project name

No.003:PRJ003  
00 02:18:017

Playlist number      Elapsed playback time

Playback stops at the end of the final project.

## HINT

Audio tracks assigned to the current list play back.

Button operation during playback

	Playback from the top of the current project
	Stop playback and return to the top of the present project
	Start playback from the top of the first project in the list
	Stop playback and start playback from the top of the next project in the list
	Stop playback and start playback from the top of the previous project in the list

## Edit a playlist

PROJECT>SEQUENCE PLAY>EDIT

- Press [▼].

List1:2Songs  
>EDIT

Change menu

(ENTER) Press [ENTER].
- Register, edit and change projects
- Select the first project (or the project to change).

The end of the project list or no projects registered

Track1  
End of List

End of list display

Change project
- Register project to be played.

Project number you want to register      Project name you want to register.

No.001:PRJ001  
003:00:047      1/1

Project: playback length      Total number of tracks  
Selected track number
- Select and register more projects.

Track2  
End of List

Change track

No.002:PRJ002  
004:00:01      2/2
- Press [EXIT].



## Remove a project from a list

- 6 Select a project to remove.

No.002 : PRJ002 3/5  
004:00:01

Change track

Press [▼].

Change project

- 7
- No.002:PRJ002  
INSERT [DELETE]
- Change item

Select **DELETE** .

Press [ENTER].

No.002:PRJ002 3/4  
004:00:01

## Insert a project into a list

- 6 Select the track to insert to.

No010:PRJ010 4/5  
002:14:58

Change track

Press [▼].

Change project

- 7 Select **INSERT** .

Track5  
[INSERT] DELETE

Change item

Press [ENTER].

No.010:PRJ010 4/6  
002:14:58

Selected project is inserted

## Delete a Playlist

PROJECT>SEQUENCE PLAY>DELETE

- 4 Press [▼].

List1:2Songs  
>EDIT

Change menu

- 5 Select **>DELETE** .

List1:2Songs  
>DELETE

Change menu

Press [ENTER].

- 6 Delete.

List1:2Songs  
Delete?

Press [ENTER].

## NOTE

- If a master track or the file assigned to the master track is deleted, the playlist will become empty.
- Set the master track to the recording that you want to hear when you register a project in a playlist.
- To change the files of registered projects, change the master tracks and edit the playlist.
- The maximum number of playlists is 10, and each playlist can have a maximum of 99 registered projects.
- To register a project, the master track must have a recorded file with a length of at least 4 seconds.







Ref. : Master Track setting

P.46

## Recording format bit rate setting

Usually CDs are recorded in 16-bit, 44.1 kHz format, but with the R16 you can also use higher quality 24-bit recording.

### Setting and changing the bit rate PROJECT>REC SETTING>BIT RATE

- 1 **PROJECT**  
 Press [PROJECT].
- 2 Select >REC SETTING.  
 Change menu  
 Press [ENTER].
- 3 Select >BIT LENGTH.  
 Change menu  
 Press [ENTER].
- 4 Select bit number.  
 16bit  
 Press [ENTER]. 16bit – 24bit

### HINT











- If you are overwriting a recording, you cannot change this.
- This setting is stored for each project.
- The initial setting is 16bit.
- If you use 44.1 kHz/24-bit, you will have to convert to 16-bit to create an audio CD.

# Adjusting the display

You can adjust the backlight and contrast.

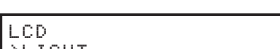









## Turning the backlight On/Off

TOOL>SYSTEM>LCD>LIGHT

- 1 **TOOL**  
 Press [TOOL].  
 Change menu  
◀ ▶
  - 2 Select >SYSTEM.  
 ◀ ▶  
 Press [ENTER].
  - 3 Select >LCD.  
 Change menu  
◀ ▶  
 Press [ENTER].
  - 4 Select >LIGHT.  
 Change menu  
◀ ▶  
 Press [ENTER].
  - 5 Select ON/OFF.  
Turn On/Off  
   
 Press [ENTER].
- |            |                                |
|------------|--------------------------------|
| <b>On</b>  | Backlight on (default setting) |
| <b>Off</b> | Backlight off                  |

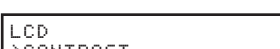
## Adjusting the contrast

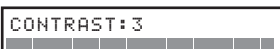
TOOL>SYSTEM>LCD>CONTRAST













- 1 **TOOL**  
 Press [TOOL].  
 Change menu  
◀ ▶
- 2 Select >SYSTEM.  
 ◀ ▶  
 Press [ENTER].
- 3 Select >LCD.  
 Change menu  
◀ ▶  
 Press [ENTER].
- 4 Select >CONTRAST.  
 Change menu  
◀ ▶  
 Press [ENTER].
- 5 Select a number.  
Change number  
   
 Press [ENTER].

## HINT

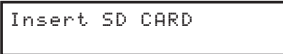
Turn the back light off to conserve the batteries.



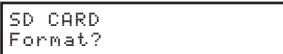

# Changing the SD card while the power is on

You can change the SD card with the power on. You might need to change an SD card when using the R16 if the remaining capacity of the inserted card becomes low, or when you need to import data from a previously recorded SD card.

- 1 **TOOL**  
 Press [TOOL].
- 2 Select >SD CARD.  
  
 Press [ENTER].
- 3 Select >EXCHANGE.  
  
 Press [ENTER].  
 Change menu  
  
 Card removal possible
- 4 Eject SD card.  
  

- 5 Insert another SD card.  
  
  
 SD card is new and not formatted for the R16.  
  
 SD card formatted for R16.
- 6 Format the SD card for use.  
  
 Press [ENTER].

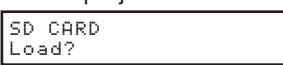





## Load the SD card to use in the R16

SD CARD DATA&gt;LOAD

- SD card formatted for the R16
- 6 Select [LOAD].  
  
 Change menu  
 Press [ENTER].
- 7 Load a project on the card.  
  
 Press [ENTER].  
 The lowest-numbered project on the inserted SD card is loaded.

## Save current R16 project to the SD card

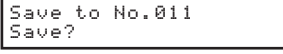
SD CARD DATA&gt;SAVE



- SD card formatted for the R16
- 6 Select [SAVE].  
  
 Change menu  
 Press [ENTER].
- 7 Select the project to save to.  
  
 Save destination project number: name  
 Press [ENTER].
- 8 Save the current project.  
  
 Press [ENTER].

# Formatting SD cards and verifying card capacities

You can format SD cards for use with the R16, deleting all the data on it, and check SD card capacity (remaining space).



## Format SD card and delete all data

TOOL>SD CARD>FORMAT

- 1 **TOOL**  
 Press [TOOL].
- 2 Select >SD CARD .  
 Change menu  
 Press [ENTER].
- 3 Select >FORMAT .  
 Change menu  
 Press [ENTER].
- 4 Execute.  
  
 Press [ENTER].

## Verify SD card remaining capacity

TOOL>SD CARD>REMAIN

- 1 **TOOL**  
 Press [TOOL].
  - 2 Select >SD CARD .  
 Change menu  
 Press [ENTER].
  - 3 Select >REMAIN .  
 Change menu  
 Press [ENTER].
- SD CARD REMAIN  
 054:06:00 / 15317.7MB

Remaining recording time for the current recording format	Remaining capacity of the card
-----------------------------------------------------------------	--------------------------------------

### NOTE

- If you insert an SD card that has not been formatted for use with the R16, the "FORMAT" menu opens automatically.
- If you format an SD card, all its data will be permanently erased.
- When you format an SD card, all data on the card will be deleted, and folders and files exclusively for R16 use will be created.

Data structure of R16 SD cards

```

├─ PROJ00
│  └─ PRJDATA.ZID
│     └─ EFXDATA.ZID
│        └─ AUDIO
├─ SYS
│  └─ ZOOM.ZDT
└─
  
```

### NOTE

- If the remaining capacity of an SD card is less than the amount of recording data, recording will fail. Change the card before you run out of space.

 Ref. : Importing data from USB memory to an SD card  
 : Saving data from an SD card to USB memory  
 : Operation without an SD card

P.76

P.12

### NOTE

- Release the write-protection lock of the SD card before inserting it.
- [SAVE] includes various data for the project in use, but no audio data is saved.

### HINT

- Insert an unformatted SD card and execute when "Format?" appears. Then options to [SAVE] and [LOAD] the present project will follow.

## Confirming the version & setting the battery type

You can confirm the current version of the system software. If you set the battery type, the remaining battery charge will be displayed more accurately.

### Confirming the system version

TOOL>SYSTEM>SYSTEM VERSION

- TOOL**  
 Press [TOOL].

TOOL  
 >TUNER

Change menu
- Select >SYSTEM.

TOOL  
 >SYSTEM

Press [ENTER].

SYSTEM  
 >LCD

Change menu
- Select >VERSION.

SYSTEM  
 >VERSION

Press [ENTER].
- Select the type of information.

SYSTEM  
 Ver ZOOM R16  
 SYSTEM Ver: 1.00

Current system version

SUB  
 SYSTEM Ver ZOOM R16  
 SUB SYSTEM Ver: 1.00

Current sub-system version

BOOT  
 SYSTEM Ver ZOOM R16  
 BOOT SYSTEM Ver: 1.00

Current boot system version

### Set the type of batteries

TOOL>SYSTEM>BATTERY TYPE

- TOOL**  
 Press [TOOL].

TOOL  
 >TUNER

Change menu
- Select >SYSTEM.

TOOL  
 >SYSTEM

Press [ENTER].

SYSTEM  
 >LCD

Change menu
- Select >BATTERY TYPE.

SYSTEM  
 >BATTERY TYPE

Press [ENTER].
- Select the type of battery.

BATTERY TYPE  
 ALKALINE

Type of battery set

Press [ENTER].

ALKALINE	Alkaline batteries
Ni-MH	Nickel-metal hydride batteries

Default value: ALKALINE

### NOTE

Please use only either alkaline or nickel-metal hydride batteries.

### HINT

You can check for up-to-date system software information at the ZOOM WEB site:  
[www.zoom.co.jp](http://www.zoom.co.jp)

## Computer connection

Use USB to connect an R16 to a computer (Windows or Macintosh OS) .

By connecting this unit to a computer, you can use it as an SD card reader, an audio interface for sound input and output and a control surface to control DAW software.

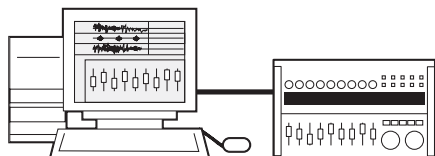

### NOTE

- To import an audio file into the R16, its format must be WAV with a sampling frequency of 44.1 kHz and a bit rate of 16 or 24.
- File names should use only capital letters, numbers and the "\_" (underscore). They should be 8 or fewer characters plus the ".WAV" extension.
- You can connect the R16 and a computer by USB when the power is on. If you connect the R16 by USB when its [POWER] switch is OFF, you can start it up with power supplied over USB.
- When you are using the R16 as a card reader or as an audio interface, you cannot use it as a recorder.

### HINT

- Card reader OS compatibility  
Windows: Windows XP and later  
Macintosh: Mac OS x 10.2 and later
- Project data is saved to the ROOT DIRECTORY of the SD card as PROJxxx (xxx is the project number) and audio data is saved as "WAV" files inside "AUDIO" in the project directory.
- The MASTER track and stereo tracks are stereo WAV files.

# Card reader

You can access the R16 SD card through a computer to backup, read and import various data, projects and files.



## Using as an SD card reader

USB>CARD READER

1 Connect the R16 with a computer by USB (DEVICE JACK).

2  Press [USB].

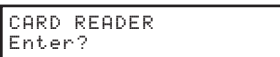
3 Select >CARD READER .  
  
 Press [ENTER].

4 Execute.  
  
 Press [ENTER].

Operating the R16 from a computer.

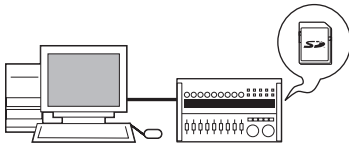

### To computer

Back up project data on an SD card to a computer.

### From computer

Import to an SD card from a backup of audio and computer data.

## Disconnecting

1 To properly disconnect the R16 from your computer, follow your operating system's procedure for removing hardware.

2  or  Press to disconnect the R16 as a card reader.

## NOTE

- To import an audio file into the R16, its format must be WAV with a sampling frequency of 44.1 kHz and a bit rate of 16 or 24.
- File names should use only capital letters, numbers and the "\_" (underscore). They should be 8 or fewer characters plus the ".WAV" extension.

## HINT

- Card reader OS compatibility  
Windows: Windows XP and later  
Macintosh: Mac OS x 10.2 and later
- Project data is saved to the ROOT DIRECTORY of the SD card as PROJxxx (xxx is the project number) and audio data is saved as "WAV" files inside "AUDIO" in the project directory.
- The MASTER track and stereo tracks are stereo WAV files.
- To import WAV files from a computer, copy them to the "AUDIO" folder in the "PROxxx" project folder (xxx=project number) where you want to use them. Use the R16 to assign the files to tracks.
- You can connect the R16 to a computer by USB when the power is on.
- If you connect the R16 by USB when its [POWER] switch is OFF, you can start it up with power supplied over USB.













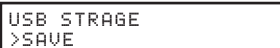

# Using USB memory to save and import data

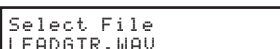
By connecting USB memory directly to the R16, you can save and import files.  
This is convenient for exchanging files with band members.



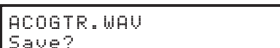







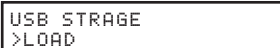

## Saving to USB memory

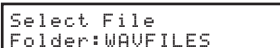
USB>USB STORAGE>SAVE

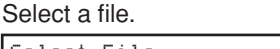
- 1 Connect the USB memory to the USB Host Jack of the R16.
- 2 **USB**  
 Press [USB].
- 3 Select >USB STORAGE.  
 Change menu  
 Press [ENTER].
- 4 Select >SAVE.  
 Change menu  
 Press [ENTER].
- 5 Select project with data to save.  
 Change project  
 Press [ENTER].
- 6 Select a file.  
 Change project  
 Press [ENTER].
- 7 Select the data to save.  
 Change file  
 Press [ENTER].  
 Change the name of the file to be saved.
- 8 Save the file.  
  
 Press [ENTER].

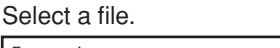
## Importing from USB MEMORY

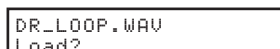
USB>USB STORAGE>LOAD

- 1 Connect USB MEMORY to the USB Host Jack of the R16.
- 2 **USB**  
 Press [USB].
- 3 Select >USB STORAGE.  
 Change menu  
 Press [ENTER].
- 4 Select >LOAD.  
 Change menu  
 Press [ENTER].
- 5 Select the folder.  
 Change folders and files  
Appears if there is a folder.  
 Press [ENTER].
- 6 Select a file.  
 Change folders and files  
 Press [ENTER].
- 7 Select a file.  
 Change file  
 Press [ENTER].
- 8 Load the file.  
  
 Press [ENTER].

## NOTE

- Never remove the USB memory when sending and receiving data. Disconnect after the "Saving" or "Loading" display is gone.
- During USB storage use, no recording is possible.
- When saving on USB memory, the saved data is stored at the top level of the file structure.

## Audio interface/control surface

Connect the R16 by USB to a computer to use it as a controller and as an audio interface with DAW software.

### Connecting the R16 as an audio interface/control surface

#### 1. Audio interface mode

By using the R16 as an interface between a computer and other audio equipment and instruments, you can record and edit audio signals with DAW software.

You can also connect instruments that require Hi-Z or phantom power.

#### 2. Control surface mode

Using the faders and keys on the R16, you can control transport and mixer operations in your DAW software.

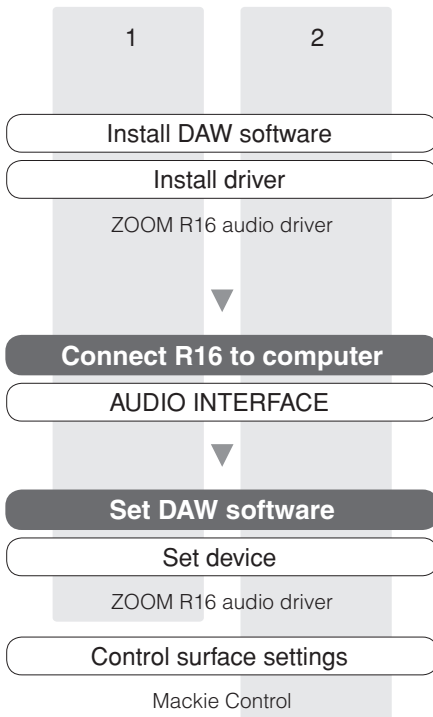

### Connecting the R16 with a computer for the first time



- 1 Install ZOOM R16 USB Audio drivers on the computer.
- 2 Connect the R16 to the computer.
  - Set and connect the R16
- 3 Set DAW software.
  - Device settings
  - Control surface settings

### NOTE

- To use the R16 as an audio interface for DAW software (for example, Cubase LE 4) it is necessary to install the ZOOM R16 USB audio driver. Install it correctly according the included installation guide.
- Please download the latest version of the ZOOM R16 USB audio driver from our home page, <http://www.zoom.co.jp>.

## Connecting and setting the R16

Follow these procedures from the second time connecting

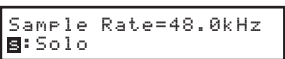
- 1 **USB**  
 Press [USB].
- 2 Select >AUDIO INTERFACE.  
  
 Press [ENTER].
- 3 Confirm.  
  
 Press [ENTER].
- 4 Select whether to use previous settings.  
  
 Press [ENTER].
- 5 Connect USB cable to R16.  

[DEVICE] USB indicator lights

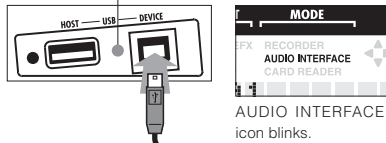

- 6 Connect USB cable to the computer.



AUDIO INTERFACE icon lights after connection



## Disconnecting

- 1 **USB**  
 Press [USB].
- 2 Disconnect.  
  
 Press [ENTER].
- 3 Unplug the USB cable.

### NOTE

You can use the settings and values of the last project in a new one or reset them to the defaults

#### Data transferred with CONTINUE

- INSERT EFFECT settings
- SEND RETURN EFFECT settings
- Track parameter settings
- TUNER settings

#### RESET

Default settings for each item

### NOTE

- Before you unplug the USB cable when disconnecting from a computer, follow the proper procedures for the computer OS to disconnect the device first.
- After step 2 of "Disconnecting" above, unplug the USB cable only after "AUDIO INTERFACE" disappears from the R16 display.
- Even without power from the R16 (adapter or batteries), you can start-up with just USB bus power when using the audio interface/control surface functions.
- We strongly recommend that you always keep the R16 system software up-to-date. If you use an R16 running an old system, a computer might not recognize it.





# R16 effect types and parameters 1

## Effect parameters

Insert effect

CLEAN, DISTORTION, ACO/BASS SIM algorithms

### ● COMP/LIMITER module

Type	Parameters/Descriptions			
	Sense	Attack	Tone	Level
Compressor	MXR Dynacomp type compressor.			
Rack Comp	Threshold	Ratio	Attack	Level
	Compressor with more detailed adjustments.			
Limiter	Threshold	Ratio	Release	Level
	Limiter for suppressing signal peaks above a certain level.			

Parameter descriptions

Parameter name	Setting range	Description
Sense	0~10	Adjusts compressor sensitivity.
Attack	Compressor: Fast, Slow	Selects compressor response speed.
	Rack Comp: 1~10	Adjusts compressor response speed.
Tone	0~10	Adjusts tonal quality.
Level	2~100	Adjusts signal level after passing module.
Threshold	0~50	Adjusts threshold for compressor/limiter action.
Ratio	1~10	Adjusts compressor/limiter compression ratio.
Release	1~10	Adjusts delay until compressor/limiter release from point where signal level falls below threshold level.

### ● EFX module

Type	Parameters/Descriptions						
	Position	Sense	Resonance	Level			
Auto Wah	Auto wah dependent on dynamics of input signal.						
Tremolo	Depth	Rate	Wave	Level			
	Periodically varies the volume level.						
Phaser	Position	Rate	Color	Level			
	Produces a swooshing sound.						
Ring Modulator	Position	Frequency	Balance	Level			
	Produces a metallic ringing sound. Adjusting the Frequency parameter results in a drastic change of sound character.						
Slow Attack	Position	Time	Curve	Level			
	Slows down the attack rate of the sound.						
Fix-Wah	Position	Frequency	Dry Mix	Level	RTM Mode	RTM Wave	RTM Sync
	Changes the wah frequency according to rhythm tempo.						

Parameter descriptions

Parameter name	Setting range	Description
Position	Before, After	Sets connection position of EFX module to "before" or "after" preamp.
Sense	-10~-1, 1~10	Adjusts auto wah sensitivity.
Resonance	0~10	Adjusts resonance intensity.
Level	2~100	Adjusts signal level after passing module.
Depth	0~100	Adjusts modulation depth.
Rate	0~50 ♪ (P86 Table1)	Adjusts modulation rate. Can be set in rhythm tempo note units.
Wave	Up 0~9, Down 0~9, Tri 0~9	Sets modulation waveform to "Up" (rising sawtooth), "Down" (falling sawtooth), or "Tri" (triangular). Higher values result in stronger clipping, emphasizing the effect.
Color	4Stage, 8State, Invert4, Invert8	Selects sound type.
Frequency	Ring Modulator: 1~50	Adjusts frequency used for modulation.
	Fix-Wah: 1~50	Adjusts wah center frequency.
Balance	0~100	Adjusts balance between original sound and effect sound.
Time	1~50	Adjusts rise time for sound.
Curve	0~10	Adjusts volume rise curve.
Dry Mix	0~10	Adjusts original sound mix ratio.
RTM Mode	P86 Table 2	Adjusts change range and direction.
RTM Wave	P86 Table 3	Selects control waveform.
RTM Sync	♪ (P86 Table 4)	Adjusts control frequency.

# R16 effect types and parameters 2

## ● PREAMP module

Type	Parameters/Descriptions			
<b>FD Clean</b>	Clean sound of Fender Twin Reverb ('65 model) favored by guitarists of many music styles.			
<b>VX Clean</b>	Clean sound of combo amp VOX AC-30 operating in class A.			
<b>JC Clean</b>	Clean sound of Roland JC series with built-in chorus which gives a broad, clear tone.			
<b>HW Clean</b>	Clean sound of legendary all-tube Hiwatt Custom 100 from Britain.			
<b>UK Blues</b>	Crunch sound of 30-watt combo amp Marshall 1962 Bluesbreaker.			
<b>US Blues</b>	Crunch sound of Fender Tweed Deluxe '53.			
<b>TweedBass</b>	Crunch sound of Fender Bassman, a bass amp with a strong presence.			
<b>BG Crunch</b>	Crunch sound of Mesa Boogie MkIII combo amp.			
<b>MS #1959</b>	Crunch sound of legendary Marshall 1959.			
<b>MS Drive</b>	High gain sound of Marshall JCM2000 stack amp.			
<b>Rect Vnt</b>	High gain sound of Mesa Boogie Dual Rectifier red channel (vintage mode).			
<b>HK Drive</b>	High gain sound of Hughes & Kettner flagship model Triamp MKII.			
<b>DZ Drive</b>	High gain sound of the Diezel Herbert hand-made German guitar amp with three separately controllable channels.			
<b>ENGL Drive</b>	Drive sound of ENGL Ritchie Blackmore Signature 100.			
<b>PV Drive</b>	High gain sound of Peavey 5150 developed in cooperation with a world-famous hard rock guitarist.			
<b>TS+FD CMB</b>	Combination of Fender combo amp and Ibanez TS-9 sound.			
<b>SD+MS STK</b>	Combination of Marshall stack amp and Boss SD-1 sound.			
<b>FZ+MS STK</b>	Combination of Fuzz Face and Marshall stack amp sound.			
	<b>Gain</b>	<b>Tone</b>	<b>Cabinet</b>	<b>Level</b>
	FD Clean - FZ+MS STK have the same parameters.			
<b>Acoustic Sim</b>	<b>Top</b>	<b>Body</b>	<b>Level</b>	
	This effect makes an electric guitar sound like an acoustic guitar.			
<b>Aco_Ere Pre</b>	<b>Color</b>	<b>Tone</b>	<b>Level</b>	
	This is a dedicated preamp for electroacoustic guitar.			
<b>Bass Sim</b>	<b>Tone</b>	<b>Level</b>		
	This effect makes an electric guitar sound like a bass guitar.			

### Parameter description

Parameter name	Setting range	Description
<b>Gain</b>	0~100	Adjusts preamp gain (distortion intensity).
<b>Tone</b>	0~30	Adjusts tonal quality.
<b>Cabinet</b>	0~2	Adjusts speaker cabinet sound intensity.
<b>Level</b>	1~100	Adjusts signal level after passing module.
<b>Top</b>	0~10	Adjusts characteristic acoustic guitar string resonance.
<b>Body</b>	0~10	Adjusts characteristic acoustic guitar body resonance.
<b>Color</b>	1~4	Adjusts characteristics of dedicated electroacoustic guitar preamp.

## ● 3Band EQ module

Type	Parameter/Description			
<b>3Band EQ</b>	<b>Bass</b>	<b>Middle</b>	<b>Treble</b>	<b>Level</b>
	This is a 3-band equalizer.			

### Parameter description

Parameter name	Setting range	Description
<b>Bass</b>	-12dB~12dB	Adjusts low frequency boost/cut.
<b>Middle</b>	-12dB~12dB	Adjusts mid frequency boost/cut.
<b>Treble</b>	-12dB~12dB	Adjusts high frequency boost/cut.
<b>Level</b>	2~100	Adjusts signal level after passing module.

## ● MOD/DELAY module

Type	Parameters/Descriptions			
<b>Chorus</b>	<b>Depth</b>	<b>Rate</b>	<b>Tone</b>	<b>Mix</b>
	Mixes a variable pitch-shifted component with the original signal, resulting in a full-bodied resonating sound.			
<b>Ensemble</b>	<b>Depth</b>	<b>Rate</b>	<b>Tone</b>	<b>Mix</b>
	Chorus ensemble with three-dimensional movement.			
<b>Flanger</b>	<b>Depth</b>	<b>Rate</b>	<b>Resonance</b>	<b>Manual</b>
	Produces a resonating and strongly undulating sound.			
<b>Pitch</b>	<b>Shift</b>	<b>Tone</b>	<b>Fine</b>	<b>Balance</b>
	Shifts the pitch up or down.			

# R16 effect types and parameters 3

Vibe	<b>Depth</b>	<b>Rate</b>	<b>Tone</b>	<b>Balance</b>
	Effect with automatic vibrato.			
Step	<b>Depth</b>	<b>Rate</b>	<b>Resonance</b>	<b>Shape</b>
	Special effect that changes the sound in a staircase pattern.			
Cry	<b>Range</b>	<b>Resonance</b>	<b>Sense</b>	<b>Balance</b>
	Varies the sound like a talking modulator.			
Exciter	<b>Frequency</b>	<b>Depth</b>	<b>Low Boost</b>	
	Enhances the sound outline, making it more prominent.			
Air	<b>Size</b>	<b>Reflex</b>	<b>Tone</b>	<b>Mix</b>
	Recreates the airy ambience of a room, with a feeling of depth.			
Delay	<b>Time</b>	<b>Feedback</b>	<b>Hi Damp</b>	<b>Mix</b>
	Delay effect with a maximum setting of 2000 ms.			
Analog Delay	<b>Time</b>	<b>Feedback</b>	<b>Hi Damp</b>	<b>Mix</b>
	Delay effect with a maximum setting of 2000 ms. Simulates the warm sound of an analog delay.			
Reverse Delay	<b>Time</b>	<b>Feedback</b>	<b>Hi Damp</b>	<b>Balance</b>
	Reverse delay effect with a maximum setting of 1000 ms.			
ARRM Pitch	<b>Type</b>	<b>Tone</b>	<b>RTM Wave</b>	<b>RTM Sync</b>
	Changes the pitch of the original sound in time with the tempo of a rhythm.			

## Parameter descriptions

Parameter name	Setting range	Description
Depth	Exciter: 0~30	Adjusts effect depth.
	All others: 0~100	Adjusts modulation depth.
Rate	Chorus, Ensemble: 1~50	Adjusts modulation rate.
	Flanger, Vibe, Step: 0~50 ♪(P.86 Table 1)	Adjusts modulation rate. Using a rhythm tempo as reference, setting in note units is also possible.
Tone	0~10	Adjusts tonal quality.
Mix	0~100	Adjusts mix ratio of effect sound to original sound.
Resonance	Flanger: -10~10	Adjusts resonance intensity. Negative values result in reversed phase of effect sound.
	Step, Cry: 0~10	Adjusts effect intensity.
Manual	0~100	Adjusts frequency range of effect.
Shift	-12~12, 24	Adjusts pitch shift amount in semitone units.
Fine	-25~25	Adjusts pitch shift amount in cent (1/100 semitone) units.
Balance	0~100	Adjusts balance between original sound and effect sound.
Shape	0~10	Adjusts effect sound envelope.
Range	1~10	Adjusts frequency range of effect.
Sense	-10~-1, 1~10	Adjusts effect sensitivity.
Frequency	1~5	Adjusts frequency of effect.
Low Boost	0~10	Adjusts low frequency boost.
Size	1~100	Adjusts size of simulated space.
Reflex	0~10	Adjusts amount of wall reflections.
Time	Wide: 1~64	Adjusts delay time.
	Delay, Analog Delay: 1~2000ms ♪(P.86 Table 1)	
	Reverse Delay: 10~1000ms ♪(P.86 Table 1)	
Wet Level	0~30	Adjusts effect sound level.
Dry Level	0~30	Adjusts original sound level.
Feedback	0~100	Adjusts feedback amount.
Hi Damp	0~10	Adjusts intensity of delay sound high range damping.
Type	P.86 Table 5	Selects pitch change type.
RTM Wave	P.86 Table 3	Selects control waveform.
RTM Sync	P.86 Table 4	Selects control waveform cycle.

## ● ZNR module

Type	Parameter/Description	
ZNR	<b>Threshold</b>	
	ZOOM original noise reduction for reducing noise during playing pauses without affecting the overall tone.	

## Parameter description

Parameter name	Setting range	Description
Threshold	Off, 1~30	Adjusts ZNR sensitivity. For maximum noise reduction, set value as high as possible without causing the sound to decay unnaturally.



# R16 effect types and parameters 4

## BASS algorithm

### ● COMP/LIMITER module

Type	Parameters/Descriptions
<b>Rack Comp Limiter</b>	For an explanation of types and parameters, see CLEAN, DISTORTION, ACO/BASS SIM algorithms.

### ● EFX module

Type	Parameters/Descriptions										
<b>Auto Wah</b>	<table border="1"> <thead> <tr> <th>Position</th> <th>Sense</th> <th>Resonance</th> <th>Dry Mix</th> <th>Level</th> </tr> </thead> <tbody> <tr> <td colspan="5">This effect varies the wah action according to the intensity of the input signal.</td> </tr> </tbody> </table>	Position	Sense	Resonance	Dry Mix	Level	This effect varies the wah action according to the intensity of the input signal.				
Position	Sense	Resonance	Dry Mix	Level							
This effect varies the wah action according to the intensity of the input signal.											
<b>Tremolo</b>	For an explanation of types and parameters, see CLEAN, DISTORTION, ACO/BASS SIM algorithms.										
<b>Phaser</b>											
<b>Ring Modulator</b>											
<b>Slow Attack</b>											
<b>Fix-Wah</b>											

#### Parameter descriptions

Parameter name	Setting range	Description
<b>Position</b>	Before, After	Sets insert position of EFX module to "Before" (before PREAMP) or "After" (after PREAMP).
<b>Sense</b>	-10~-1.1~10	Adjusts auto wah sensitivity.
<b>Resonance</b>	0~10	Adjusts resonance intensity.
<b>Dry Mix</b>	0~10	Adjusts original sound mix ratio.
<b>Level</b>	2~100	Adjusts signal level after passing module.

### ● PREAMP module

Type	Parameters/Descriptions										
<b>SVT</b>	Simulation of Ampeg SVT sound.										
<b>Bassman</b>	Simulation of Fender Bassman sound.										
<b>Hartke</b>	Simulation of Hartke HA3500 sound.										
<b>Super Bass</b>	Simulation of Marshall Super Bass sound.										
<b>SANSAMP</b>	Simulation of Sansamp Bass Driver DI sound.										
<b>Tube Preamp</b>	ZOOM original tube preamplifier sound.										
	<table border="1"> <thead> <tr> <th>Gain</th> <th>Tone</th> <th>Cabinet</th> <th>Balance</th> <th>Level</th> </tr> </thead> <tbody> <tr> <td colspan="5">All PREAMP modules have the same parameters.</td> </tr> </tbody> </table>	Gain	Tone	Cabinet	Balance	Level	All PREAMP modules have the same parameters.				
Gain	Tone	Cabinet	Balance	Level							
All PREAMP modules have the same parameters.											

#### Parameter descriptions

Parameter name	Setting range	Description
<b>Gain</b>	0~100	Adjusts preamp gain (distortion depth).
<b>Tone</b>	0~30	Adjusts tonal quality.
<b>Cabinet</b>	0~2	Adjusts intensity of speaker cabinet sound.
<b>Balance</b>	0~100	Adjusts mix balance of signal before and after module.
<b>Level</b>	1~100	Adjusts signal level after passing module.

### ● 3Band EQ module

Type	Parameters/Descriptions
<b>3Band EQ</b>	For an explanation of types and parameters, see CLEAN, DISTORTION, ACO/BASS SIM algorithms.

### ● MOD/DELAY module

Type	Parameters/Descriptions
<b>Chorus</b>	For an explanation of types and parameters, see CLEAN, DISTORTION, ACO/BASS SIM algorithms.
<b>Ensemble</b>	
<b>Flanger</b>	
<b>Pitch</b>	
<b>Vibe</b>	
<b>Step</b>	
<b>Cry</b>	
<b>Exciter</b>	
<b>Air</b>	
<b>Delay</b>	
<b>Analog Delay</b>	
<b>Reverse Delay</b>	
<b>ARRM Pitch</b>	

### ● ZNR module

Type	Parameters/Descriptions
<b>ZNR</b>	For an explanation of types and parameters, see CLEAN, DISTORTION, ACO/BASS SIM algorithms.

# R16 effect types and parameters 5

## MIC algorithm

### ● COMP/LIMITER module

Type	Parameters/Descriptions
Rack Comp Limiter	For an explanation of types and parameters, see CLEAN, DISTORTION, ACO/BASS SIM algorithms.

### ● EFX module

Type	Parameters/Descriptions
Tremolo	For an explanation of types and parameters, see CLEAN, DISTORTION, ACO/BASS SIM algorithms.
Phaser	
Ring Modulator	
Slow Attack	
Fix-Wah	

### ● MIC PRE module

Type	Parameters/Description				
Mic Pre	Type	Tone	Level	De-Esser	Low Cut
	This is a preamplifier for using an external microphone.				

#### Parameter descriptions

Parameter name	Setting range	Description
Type	Vocal, AcousticGt, Flat	Selects preamp characteristics.
Tone	0~10	Adjusts tonal quality.
Level	1~100	Adjusts signal level after passing module.
De-Esser	Off, 1~10	Controls the de-esser setting.
Low Cut	Off, 80~240Hz	Controls a filter for reducing low frequency noise often picked up during mic recording.

### ● 3BAND EQ module

Type	Parameters/Description
3Band EQ	For an explanation of types and parameters, see CLEAN, DISTORTION, ACO/BASS SIM algorithm

### ● MOD/DELAY module

Type	Parameters/Descriptions
Chorus	For an explanation of types and parameters, see CLEAN, DISTORTION, ACO/BASS SIM algorithms.
Ensemble	
Flanger	
Pitch	
Vibe	
Step	
Cry	
Exciter	
Air	
Delay	
Analog Delay	
Reverse Delay	
ARRM Pitch	

### ● ZNR module

Type	Parameters/Description
ZNR	For an explanation of types and parameters, see CLEAN, DISTORTION, ACO/BASS SIM algorithms.

## DUAL MIC algorithm

### ● COMP/LIMITER L module

Type	Parameters/Descriptions			
Compressor L	Threshold	Ratio	Attack	Level
	Compressor for attenuating high-level signals and boosting low-level signals.			
Limiter L	Threshold	Ratio	Release	Level
	Limiter for attenuating high-level signals that exceed a certain threshold.			

#### Parameter descriptions

Parameter name	Setting range	Description
Threshold	-24~0	Adjusts threshold level of compressor/limiter.
Ratio	Compressor: 1~26	Adjusts compression ratio of compressor/limiter.
	Limiter: 1~54, ∞	

# R16 effect types and parameters 6

<b>Attack</b>	0~10	Adjusts attack rate of compressor.
<b>Level</b>	2~100	Adjusts module output level.
<b>Release</b>	0~10	Adjusts speed of limiter release after signal falls below threshold level.

## ● MIC PREAMP L module

Type	Parameters/Description	
<b>Mic Pre L</b>	For an explanation of types and parameters, see MIC algorithm.	

## ● 3BAND EQ L module

Type	Parameters/Description	
<b>3Band EQ L</b>	For an explanation of types and parameters, see CLEAN, DISTORTION, ACO/BASS SIM algorithms.	

## ● DELAY L module

Type	Parameters/Description		
<b>Delay L</b>	<b>Time</b>	<b>Feedback</b>	<b>Mix</b>
	Delay effect with a maximum setting of 2000 ms.		
<b>Echo L</b>	<b>Time</b>	<b>Feedback</b>	<b>Mix</b>
	Warm delay effect with a maximum setting of 2000 ms.		
<b>Doubling L</b>	<b>Time</b>	<b>Tone</b>	<b>Mix</b>
	Doubling effect which creates body by adding a short delay.		

### Parameter descriptions

Parameter name	Setting range	Description
<b>Time</b>	Delay L, Echo L: 1~2000ms $\mathcal{A}$ (P.89 Table 1)	Adjusts delay time.
	Doubling L: 1~100ms	
<b>Feedback</b>	0~100	Adjusts feedback amount.
<b>Tone</b>	0~10	Adjusts tonal quality.
<b>Mix</b>	0~100	Adjusts mix ratio of effect sound to original sound.

## ● COMP/LIMITER R module

Type	Parameters/Description	
<b>Compressor R Limiter R</b>	For an explanation of types and parameters, see COMP LIMITER L module.	

## ● MIC PREAMP R module

Type	Parameters/Description	
<b>Mic Pre R</b>	For an explanation of types and parameters, see MIC algorithm.	

## ● 3BAND EQ R module

Type	Parameters/Description	
<b>3Band EQ R</b>	For an explanation of types and parameters, see CLEAN, DISTORTION, ACO/BASS SIM algorithms.	

## ● DELAY R module

Type	Parameters/Descriptions	
<b>Delay R</b>	For an explanation of types and parameters, see DELAY L module.	
<b>Echo R</b>		
<b>Doubling R</b>		

## ● ZNR module

Type	Parameters/Description	
<b>ZNR</b>	For an explanation of types and parameters, see CLEAN, DISTORTION, ACO/BASS SIM algorithms.	

## STEREO algorithm

## ● COMP/LIMITER module

Type	Parameters/Descriptions					
<b>Compressor Limiter</b>	For an explanation of types and parameters, see DUAL MIC algorithm.					
<b>Lo-Fi</b>	<b>Character</b>	<b>Color</b>	<b>Distortion</b>	<b>Tone</b>	<b>EFX Level</b>	<b>Dry Level</b>
	Lo-fi effect purposely degrades sound quality.					

### ● Parameter description

Parameter name	Setting range	Description
<b>Character</b>	0~10	Adjusts filter characteristics.
<b>Color</b>	1~10	Adjusts sound color.
<b>Distortion</b>	0~10	Adjusts distortion.

# R16 effect types and parameters 7

<b>Tone</b>	0~10	Adjusts tonal quality.
<b>EFX Level</b>	0~100	Adjusts effect sound level.
<b>Dry Level</b>	0~100	Adjusts original sound level.

## ● ISO/MIC MODEL module

Type	Parameters/Descriptions				
<b>Isolator</b>	<b>Xover Lo</b>	<b>Xover Hi</b>	<b>Mix High</b>	<b>Mix Mid</b>	<b>Mix Low</b>
	Divides the signal into three frequency bands and allows individual adjustment of the mixing ratio for each band.				
<b>Mic Modeling</b>	<b>Mic Type</b>				
	Changes the character of the built-in microphones.				

### Parameter descriptions

Parameter name	Setting range	Description
<b>Xover Lo</b>	50Hz~16kHz	Adjusts low-to-mid crossover frequency.
<b>Xover Hi</b>	50Hz~16kHz	Adjusts mid-to-high crossover frequency.
<b>Mix High</b>	Off, -24~6	Adjusts high range mix level.
<b>Mix Mid</b>	Off, -24~6	Adjusts mid range mix level.
<b>Mix Low</b>	Off, -24~6	Adjusts low range mix level.
<b>Mic Type</b>	SM57	Simulation of SM57 mic suitable for recording of various analog instruments as well as guitars.
	MD421	Simulation of MD421 professional standard mic indispensable for broadcasting, recording and live applications
	U87	Simulation of U87, a standard condenser type microphone used in studios worldwide.
	C414	Simulation of C414, a famous microphone highly trusted in recording situations.

## ● 3BAND EQ module

Type	Parameters/Description
<b>3Band EQ</b>	For an explanation of types and parameters, see CLEAN, DISTORTION, ACO/BASS SIM algorithms.

## ● MOD/DELAY module

Type	Parameters/Descriptions				
<b>Chorus</b>	<b>Depth</b>	<b>Rate</b>	<b>Mix</b>		
	Mixes a variable pitch-shifted component with the original sound, resulting in full-bodied resonating tone.				
<b>Flanger</b>	<b>Depth</b>	<b>Rate</b>	<b>Resonance</b>		
	Produces a resonating and strongly undulating sound.				
<b>Phaser</b>	<b>Rate</b>	<b>Color</b>	<b>LFO Shift</b>		
	Produces a swooshing sound.				
<b>Tremolo</b>	<b>Depth</b>	<b>Rate</b>	<b>Clip</b>		
	Periodically varies the volume level.				
<b>Auto Pan</b>	<b>Width</b>	<b>Rate</b>	<b>Clip</b>		
	Shifts the panning position of the sound between left and right.				
<b>Pitch</b>	<b>Shift</b>	<b>Tone</b>	<b>Fine</b>	<b>Balance</b>	
	This effect shifts the pitch up or down.				
<b>Ring Modulator</b>	For an explanation of types and parameters, see CLEAN, DISTORTION, ACO/BASS SIM algorithms.				
<b>Delay</b>	<b>Time</b>	<b>Feedback</b>	<b>Mix</b>		
	Delay effect with a maximum setting of 2000 ms.				
<b>Echo</b>	<b>Time</b>	<b>Feedback</b>	<b>Mix</b>		
	Warm delay effect with a maximum setting of 2000 ms.				
<b>Doubling</b>	<b>Time</b>	<b>Tone</b>	<b>Mix</b>		
	Doubling effect which creates body by adding a short delay.				
<b>Dimension</b>	<b>Rise1</b>	<b>Rise2</b>			
	Effect producing spatial expansion.				
<b>Resonance</b>	<b>Depth</b>	<b>Freq Offset</b>	<b>Rate</b>	<b>Filter Type</b>	<b>Resonance</b>
	Resonance filter with LFO.				

### Parameter descriptions

Parameter name	Setting range	Description
<b>Depth</b>	0~100	Adjusts modulation depth.
<b>Resonance</b>	-10~10	Adjusts resonance intensity. Negative values result in reversed phase for the effect sound.
<b>Color</b>	4Stage ,8Stage, Invert4, Invert8	Selects sound type.
<b>LFO Shift</b>	0~180	Adjusts left/right phase shift.
<b>Width</b>	0~10	Adjusts auto pan width.

# R16 effect types and parameters 8

<b>Rate</b>	0~50 ♪ (P.86 Table 1)	Adjusts modulation rate. Using the rhythm tempo as reference, setting in note units is also possible.
<b>Clip</b>	0~10	Adds emphasis by clipping the modulation waveform.
<b>Shift</b>	-12~12,24	For an explanation of types and parameters, see CLEAN, DISTORTION, ACO/BASS SIM algorithms.
<b>Time</b>	Delay, Echo: 1~2000ms ♪ (P.86 Table 1)	Adjusts delay time.
	Doubling: 1~100ms	
<b>Feedback</b>	0~100	Adjusts feedback amount.
<b>Mix</b>	0~100	Adjusts mix ratio of effect sound to original sound.
<b>Tone</b>	0~10	Adjusts tonal quality.
<b>Fine</b>	-25~25	Adjust pitch shift amount in cent (1/100 semitone) units.
<b>Balance</b>	0~100	Adjust balance between original sound and effect sound.
<b>Rise1</b>	0~30	Adjusts stereo component intensity.
<b>Rise2</b>	0~30	Adjusts mono component intensity.
<b>Freq Offset</b>	1~30	Adjusts LFO offset.
<b>Filter Type</b>	HPF, LPF, BPF	Selects filter type.
<b>Resonance</b>	1~30	Adjusts resonance intensity.
<b>EFX Level</b>	0~100	Adjusts effect sound level.
<b>Dry Level</b>	0~100	Adjusts original sound level.

## ● ZNR module

Type	Parameters/Description
ZNR	For an explanation of types and parameters, see CLEAN, DISTORTION, ACO/BASS SIM algorithms.

**Table 1** Parameters marked with ♪ allow selection of a setting value in note units, using the song/pattern tempo as reference. The note durations for the setting values are shown below.

♪	Thirty-second note	♪.	Dotted sixteenth note	♪.	Dotted eighth note	♪:2	Quarter note x 2
♪	Sixteenth note	♪	Eighth note	♪	Quarter note	:	:
♪3	Quarter triplet note	♪3	Half triplet note	♪.	Dotted quarter note	♪:20	Quarter note x 20

## NOTE

- The note range actually available depends on the parameter.
- Depending on the combination of tempo setting and selected note symbol, the parameter setting range could be exceeded. In such case, the value is automatically halved (or set to 1/4 if the range is still exceeded).

**Table 2**

Setting value	Description
<b>Off</b>	Frequency does not change.
<b>Up</b>	Frequency changes from minimum to maximum according to the controlling waveform.
<b>Down</b>	Frequency changes from maximum to minimum according to the controlling waveform.
<b>Hi</b>	Frequency changes from patch setting to maximum according to the controlling waveform.
<b>Lo</b>	Frequency changes from minimum to patch setting according to the controlling waveform.

**Table 3**

Setting value	Description	Setting value	Description
<b>Up Saw</b>	Rising sawtooth wave	<b>Tri</b>	Triangular wave
<b>Up Fin</b>	Rising fin wave	<b>TriXTri</b>	Squared triangular wave
<b>DownSaw</b>	Falling sawtooth wave	<b>Sine</b>	Sine wave
<b>DownFin</b>	Falling fin wave	<b>Square</b>	Square wave

**Table 4**

Setting value	Description	Setting value	Description
♪	Eighth note	<b>1 bar</b>	1 measure
♪	Quarter note	<b>2 bars</b>	2 measures
♪	Half note	<b>3 bars</b>	3 measures
♪.	Dotted half note	<b>4 bars</b>	4 measures

**Table 5**

Setting value	Description	Setting value	Description
<b>1</b>	1 semitone lower — original sound	<b>10</b>	1 octave higher + original sound — 1 octave lower + original sound
<b>2</b>	Original sound — 1 semitone lower	<b>11</b>	Complete fifth down + original sound — complete fourth up + original sound
<b>3</b>	Doubling — detune + original sound	<b>12</b>	Complete fourth up + original sound — complete fifth down + original sound
<b>4</b>	Detune + original sound — doubling	<b>13</b>	0 Hz + original sound — 1 octave up
<b>5</b>	Original sound — 1 octave higher	<b>14</b>	1 octave up — 0 Hz + original sound
<b>6</b>	1 octave higher — original sound	<b>15</b>	0 Hz + original sound — 1 octave up + original sound
<b>7</b>	Original sound — 2 octaves lower	<b>16</b>	1 octave up + original sound — 0 Hz + original sound
<b>8</b>	2 octaves lower — original sound		
<b>9</b>	1 octave lower + original sound — 1 octave higher + original sound		

# R16 effect types and parameters 9

## 8x Comp EQ algorithm

Modules 1-8

Unit	Type	Parameter
HPF 1-8	HPF	<b>Frequency</b> High-pass filter blocks the low range and passes high frequencies.
COMP/LIMITER 1-8	Rack Comp Limiter	For an explanation of types and parameters, see CLEAN, DISTORTION, ACO/BASS SIM algorithms.
3BAND EQ 1-8	3Band EQ	

Parameter description

Parameter name	Setting range	Description
Frequency	80-240Hz	Adjusts cutoff frequency.

## MASTERING algorithm

### ● COMP/Lo-Fi module

Type	Parameter							
3Band Comp	Xover Lo	Xover Hi	Sense Hi	Sense Mid	Sense Low	Mix High	Mix Mid	Mix Low
	Compressor that divides the signal into three frequency bands and allows individual adjustment of compressor sensitivity and mixing ratio for each band.							
Lo-Fi	For an explanation of types and parameters, see STEREO algorithms.							

Parameter descriptions

Parameter name	Setting range	Description
Xover Lo	50Hz~16kHz	Adjusts low-to-mid crossover frequency.
Xover Hi	50Hz~16kHz	Adjusts mid-to-high crossover frequency.
Sense Hi	0~24	Adjusts high range compressor sensitivity.
Sense Mid	0~24	Adjusts mid range compressor sensitivity.
Sense Low	0~24	Adjusts low range compressor sensitivity.
Mix High	Off, -24~6	Adjusts high range mixing ratio.
Mix Mid	Off, -24~6	Adjusts mid range mixing ratio.
Mix Low	Off, -24~6	Adjusts low range mixing ratio.

### ● NORMALIZER module

Type	Parameter	
Normalizer	Gain	
	Adjusts COMP/Lo-Fi module input level.	

Parameter description

Parameter name	Setting range	Description
Gain	-12~12	Adjusts level.

### ● 3BAND EQ module

Type	Parameters/Description
3Band EQ	For an explanation of types and parameters, see CLEAN, DISTORTION, ACO/BASS SIM algorithms.

### ● DIMENSION/RESO module

Type	Parameters/Descriptions
Dimension Resonance	For an explanation of types and parameters, see STEREO algorithms.

### ● ZNR module

Type	Parameters/Description
ZNR	For an explanation of types and parameters, see CLEAN, DISTORTION, ACO/BASS SIM algorithms.

# R16 effect types and parameters 10

## Send/return effect

### ● CHORUS/DELAY module

Type	Parameters/Descriptions					
	LFO Type	Depth	Rate	Pre Delay	EFX Level	
Chorus	Mixes a variable pitch-shifted component with the original sound, resulting in full-bodied resonating tone.					
Delay	Time	Feedback	Hi Damp	Pan	EFX Level	Rev Send
	Delay effect with a maximum setting of 2000 ms.					

#### Parameter descriptions

Parameter name	Setting range	Description
LFO Type	Mono, Stereo	Sets LFO phase to mono or stereo.
Depth	0~100	Adjusts effect depth.
Rate	1~50	Adjusts modulation rate.
Pre Delay	1~30	Adjusts pre-delay time.
EFX Level	0~100	Adjusts effect sound level.
Rev Send	0~30	Adjusts delay sound reverb send level.
Time	1~2000ms ↗ (P.86 Table 1)	Adjusts delay time.
Feedback	0~100	Adjusts feedback amount.
Hi Damp	0~10	Adjusts intensity of delay sound high range damping.
Pan	Left10~Left1, Center, Right1~Right10	Adjusts delay sound panning.

### ● REVERB module

	Parameters/Descriptions					
	Pre Delay	Decay	EQ High	EQ Low	E.R.Mix	EFX Level
Hall	Simulates the acoustics of a concert hall.					
Room	Simulates the acoustics of a room.					
	Hall and Room have the same parameters.					
Spring	Simulates a spring reverb.					
Plate	Simulates a plate reverb.					
	Spring and Plate have the same parameters.					

#### Parameter description

Parameter name	Setting range	Description
Pre Delay	1~100	Adjusts pre-delay time.
Decay	1~30	Adjusts reverb time.
EQ High	-12~6	Adjusts high range effect sound.
EQ Low	-12~6	Adjusts low range effect sound.
E.R.Mix	0~30	Adjusts mix ratio of initial reflections.
EFX Level	0~100	Adjusts effect sound level.

# Effect patch list 1

## Effect Patch List

Insert effect

### CLEAN algorithm

No.	Patch name	Description
0	<b>Standard</b>	Standard clean sound optimized for line-level equipment.
1	<b>Ensemble</b>	Transparent sound with ensemble effect.
2	<b>CompPlus</b>	Universal compressor with a wide range of uses.
3	<b>R&amp;Roll</b>	Sound tailored for vintage genres such as rock'n'roll.
4	<b>CutPhase</b>	Phase effect for that great cutting style.
5	<b>Hi-WT</b>	Hiwatt amp tone gets natural distortion from the picking dynamics.
6	<b>DlyLead</b>	Clean lead patch, characterized by long delays with solid presence.
7	<b>Blues</b>	Choose this for an orthodox blues feel.
8	<b>MultiFLG</b>	Flanger suitable for many uses including arpeggio, cutting, and lead guitar.
9	<b>DaDaFunk</b>	Auto wah brings out picking nuances.
10	<b>Tremolo</b>	Twin reverb with added tremolo for color.
11	<b>BeatRock</b>	Get into the Merseybeat for rock bands.
12	<b>Rockably</b>	Rockabilly sound with effective use of short delay.
13	<b>WarmCho</b>	Combination of warm tone with deep chorus.
14	<b>Unison</b>	Unison sound with added bass (-12 shift), good for low range phrasing.
15	<b>Crunch</b>	Light crunch for rock and pop backing.
16	<b>CleanArp</b>	Wide ensemble sound that works well with arpeggios and obligato.
17	<b>CompLead</b>	Streamlined lead sound with effective compressor action.
18	<b>FastRate</b>	Fast phaser turns full chords into a unique lead sound.
19	<b>ClubJazz</b>	Simulates the ambience in a jazz club or a similar live venue.
20	<b>SlowVibe</b>	Slow attack sound for imaginative chord work.
21	<b>Ethnic</b>	ARRM effect effectively emphasizes open-string phrasing.
22	<b>Insect</b>	Special effect sound of a small insect buzzing.
23-29	<b>Empty</b>	

### DISTORTION algorithm

No.	Patch name	Description
0	<b>5-1-5-0</b>	5150 simulation, great for hard riffs.
1	<b>MS#1959</b>	British rock sound with airy distortion that comes alive at high volumes.
2	<b>AnyOD</b>	Overdrive suitable for both lead and backing.
3	<b>RectiDRV</b>	Sound modeled on the Boogie Rectifier.
4	<b>MultiLD</b>	Versatile lead tone for many applications.
5	<b>Detune</b>	Solid sound with detune effect.
6	<b>UK Blues</b>	Bluesbreaker with added delay gives fat and smooth sound.
7	<b>Fusion</b>	Fusion type sound with a surging deep chorus.
8	<b>AutoWah</b>	Versatile auto wah for lead or backing.
9	<b>JB Style</b>	Octaver sound made famous by Jeff Beck.
10	<b>Hvy Riff</b>	Choose this for heavy riffs.
11	<b>BlueLine</b>	Bluesy sound with a dry character.
12	<b>Melody</b>	Sustain sound for melodious solos.
13	<b>TalkTime</b>	Talk sound featuring a cry effect. A sense of persistence makes it easy to play.
14	<b>ArpenCho</b>	Chorus effect great for arpeggios.
15	<b>HK Drive</b>	The full-bodied sound of AMP3 high-gain distortion with added delay.
16	<b>MS Drive</b>	JCM2000 lead channel simulation. Air effect adds the cabinet touch.
17	<b>Crunch</b>	Crunch sound optimized for cutting.
18	<b>NuanceOD</b>	Overdrive sound brings out those fine amp details.
19	<b>Tremolo</b>	Tremolo sound for arpeggio.
20	<b>ShortDLY</b>	Rock lead sound with short delay.
21	<b>Half Wah</b>	Midrange-oriented sound with half open wah.
22	<b>Jet Riff</b>	Flanger jet sound.
23	<b>SmoothLD</b>	Smooth and glossy distortion sound.
24	<b>HR Core</b>	Punchy hard rock sound.
25	<b>ENGL 650</b>	Simulation of the ENGL E650 favored by Ritchie Blackmore.



## Effect patch list 2

26	<b>5thPitch</b>	Synthesizer-like pitch sound with fifth-down for ad-libbing.
27	<b>375 DLY</b>	Dotted eighth delay at 120 bpm creates a gimmicky sound for solo play.
28	<b>PsycheVB</b>	Psychedelic vibe sound of the sixties as personified by Jimi Hendrix.
29	<b>D'live</b>	Crunch sound with intense live feeling.
30	<b>NicePick</b>	Crunch sound controlled by picking.
31	<b>X'over</b>	Slack semi-acoustic sound with overdrive.
32	<b>Combo</b>	Crunch sound in the boogie combo style.
33	<b>MildTone</b>	Mild tone emphasizes the low range.
34	<b>Bright</b>	Bright and airy sound.
35	<b>OLD DLY</b>	Lead tone flavored with analog delay.
36	<b>Tweed</b>	Tweed amp sound with a clear edge.
37	<b>BoxBody</b>	Old-style semi-acoustic fusion sound.
38	<b>Big Wave</b>	Special effect sound using ARRM creates a wave that rolls back to you.
39	<b>Bottom</b>	Twang those lower strings with this sound.
40-49	<b>Empty</b>	

### ACO/BASS SIM algorithm

No.	Patch name	Description
0	<b>Ensemble</b>	Gorgeous sound with deep ensemble effect.
1	<b>Delay LD</b>	Lively acoustic guitar sound for lead playing.
2	<b>Chorus</b>	Chorus sound suitable for everything from rhythm guitar to lead guitar.
3	<b>FineTune</b>	Delicate detune creates sonic depth.
4	<b>Air Aco</b>	Air sound creates a micing effect.
5	<b>Standard</b>	Standard bass sound with many uses.
6	<b>CompBass</b>	Bass sound comes alive with compressor and exciter.
7	<b>WarmBass</b>	Bass sound with warm and round feeling.
8	<b>Flanging</b>	Flanging sound covers a lot of ground from 16-beat phrases to melody playing.
9	<b>Auto Wah</b>	Funky bass sound that makes good use of auto wah.
10-19	<b>Empty</b>	

### BASS algorithm

No.	Patch name	Description
0	<b>SVT</b>	Walk the high road of rock. Great for finger picking or flatpicking.
1	<b>BASSMAN</b>	Vintage rock sound for any occasion.
2	<b>HARTKE</b>	Hartke simulation with all the glitz and glitter.
3	<b>SUPER-B</b>	Choose this for guitar unison play and solo play.
4	<b>SANS-A</b>	Edgy sound with a strong core is a good match for flatpicking.
5	<b>TUBE PRE</b>	All-rounder tube sound always comes in handy.
6	<b>Attack</b>	Compression sound effective for slap and flatpick playing.
7	<b>Wah-Solo</b>	Solo sound with distortion and a touch of wah. Pitch shift is the secret ingredient.
8	<b>Talk&amp;Cry</b>	Typical special effect that makes a cry sound like a talking modulator.
9	<b>Melody</b>	Chorus sound for melody, solo, chord playing and harmonics.
10	<b>SlapJazz</b>	Basic slap sound in the jazz bass style.
11	<b>Destroy</b>	Smashing sound mixing distortion, pitch shifting and ring modulator.
12	<b>Tremolo</b>	A great match for a moody bass line and chord playing.
13	<b>SoftSlow</b>	Melody or solo play tone that is ideal for a fretless bass.
14	<b>Limitter</b>	Limitter evens out the sound when using a pick.
15	<b>X'over</b>	Flanger sound for picking, typical of the crossover genre.
16	<b>CleanWah</b>	Auto wah sound that has a million uses.
17	<b>Exciter</b>	Universal sound with a fresh and transparent character.
18	<b>ClubBass</b>	Play those walking phrases with this sound that simulates the ambience of a small club.
19	<b>DriveWah</b>	Auto wah sound with variable drive that follows picking dynamics.
20-29	<b>Empty</b>	

### MIC algorithm

No.	Patch name	Description
0	<b>Rec Comp</b>	Conventional preamp + compression sound for recording.
1	<b>RoomAmbi</b>	Simulates the acoustics of a radio station broadcast studio.
2	<b>VocalDly</b>	Delay effect that works best with wet vocals.
3	<b>Rock</b>	Massive compression sound for rock vocals.

# Effect patch list 3

4	<b>Long DLY</b>	Long delay sound for vocals (2-beat at 120 bpm)
5	<b>InTheBOX</b>	This effect seems to put the entire sound into a small box
6	<b>Limitr</b>	Limitr effect that is very useful for recording
7	<b>AG MIC</b>	Preamp tone that is great for recording acoustic guitar
8	<b>AG Dub</b>	Doubling sound that gives a stroke more of a pick feeling
9	<b>12st Cho</b>	Chorus sound for 12-string guitar
10	<b>AG-Jumbo</b>	Increases the apparent body size of an acoustic guitar
11	<b>AG-Small</b>	Reduces the apparent body size of an acoustic guitar
12	<b>AG Lead</b>	Delay sound for acoustic guitar leads
13	<b>Live AMB</b>	Bright reverb sound for acoustic guitar increases the live feeling
14	<b>Tunnel</b>	Simulation of tunnel reverb
15	<b>Filter</b>	Filter effect lets you change the sound character during a song
16	<b>BrethCmp</b>	Fairly strong compressor sound emphasizes breathiness
17	<b>Vib MOD</b>	Crafty vocal sound combines phaser and vibrato
18	<b>Duet Cho</b>	Detune sound creates an instant duet
19	<b>Ensemble</b>	Fresh ensemble sound great for chorus
20	<b>VocalDub</b>	Conventional doubling sound
21	<b>Sweep</b>	Voice sound with slow phase sweep
22	<b>VoiceFlg</b>	Flanging chorus sound with strong modulation
23	<b>PH Voice</b>	Gimmicky phase sound seasoned with delay
24	<b>VibVoice</b>	Clearcut vibrato sound
25	<b>FutureVo</b>	A message from the aliens
26	<b>M to F</b>	Transforms male vocals into a female sound
27	<b>F to M</b>	Transforms female vocals into a male sound
28	<b>WaReWaRe</b>	Special effect sound speaks to you from the cosmos
29	<b>Hangul</b>	Special effect sound that turns Japanese into Korean
30-49	<b>Empty</b>	

## DUAL MIC algorithm

No.	Name	Comment	Recommended L/R input
0	<b>Vo/Vo 1</b>	For duets	Vocals
1	<b>Vo/Vo 2</b>	Chorus for main vocal	Vocals
2	<b>Vo/Vo 3</b>	For harmony	Vocals
3	<b>AG/Vo 1</b>	Creates a story-like character	Acoustic guitar/Vocal
4	<b>AG/Vo 2</b>	Similar to AG/Vo 1 but vocal character different	Acoustic guitar/Vocal
5	<b>AG/Vo 3</b>	Aggressively modifies vocal character	Acoustic guitar/Vocal
6	<b>ShortDLY</b>	Short delay sound with effective doubling	Microphones
7	<b>FatDrum</b>	For drum recording with single point stereo mic	Microphones
8	<b>BothTone</b>	Tuned for male on L channel and female on R channel	Vocals
9	<b>Condnsr</b>	Simulates condenser mic sound with dynamic mic input	Vocals
10	<b>DuoAttack</b>	Chorus for lead vocals with emphasized attack	Vocals
11	<b>Warmth</b>	Warm sound with prominent midrange	Vocals
12	<b>AM Radio</b>	Simulates AM monaural radio	Vocals
13	<b>Pavilion</b>	Narration sound at expo booths	Vocals
14	<b>TV News</b>	TV newscaster sound	Vocals
15	<b>F-Vo/Pf1</b>	For female vocal piano ballads	Vocal/Piano
16	<b>JazzDuo1</b>	Simulates jazz session LP with lo-fi sound	Vocal/Piano
17	<b>Cntmprry</b>	All-round clear sound	Vocal/Piano
18	<b>JazzDuo2</b>	JazzDuo 1 for male vocal	Vocal/Piano
19	<b>Ensemble</b>	For guitar with strong attack and mellow piano	Acoustic guitar/Piano
20	<b>Enhanced</b>	Enhances clear, strong outline for ballads	Acoustic guitar/Vocal
21	<b>Warmy</b>	Moderates overbright ambience	Acoustic guitar/Vocal
22	<b>Strum+Vo</b>	Smooth fat sound with midrange compensation	Acoustic guitar/Vocal
23	<b>FatPlus</b>	Spruces up a thin midrange	Acoustic guitar/Vocal
24	<b>Arp+Vo</b>	Overall solid sound	Acoustic guitar/Vocal
25	<b>ClubDuo</b>	Simulates live sound in small club	Acoustic guitars
26	<b>BigShape</b>	Enhances overall clarity	Acoustic guitars
27	<b>FolkDuo</b>	Fresh and clean sound	Acoustic guitars
28	<b>GtrDuo</b>	Suitable for guitar duos	Acoustic guitars
29	<b>Bright</b>	Bright and sharp global feeling	Acoustic guitars
30-49	<b>Empty</b>		

# Effect patch list 4

STEREO algorithm		
No.	Name	Comment
0	<b>Syn-Lead</b>	For synthesizer single note lead
1	<b>OrganPha</b>	Phaser for synthesizer/organ
2	<b>OrgaRock</b>	Boomy distortion for rock organ
3	<b>EP-Chor</b>	Beautiful chorus for electric piano
4	<b>ClavFlg</b>	Wah for clavinet
5	<b>Concert</b>	Concert hall effect for piano
6	<b>Honkey</b>	Honky-tonk piano simulation
7	<b>PowerBD</b>	Gives a bass drum more power
8	<b>DrumFlng</b>	Conventional flanger for drum
9	<b>LiveDrum</b>	Simulates outdoor live doubling
10	<b>JetDrum</b>	Phaser for 16-beat hi-hat
11	<b>AsianKit</b>	Changes a standard kit to an Asian kit
12	<b>BassBost</b>	Emphasizes low range
13	<b>Mono-&gt;St</b>	Gives spaciousness to a monaural source
14	<b>AM Radio</b>	AM radio simulation
15	<b>WideDrum</b>	Wide stereo effect for drum machine track
16	<b>DanceDrum</b>	Reinforces bass for dance rhythms
17	<b>Octaver</b>	Adds one-octave lower sound
18	<b>Percushn</b>	Gives air, presence, and stereo spread to percussion
19	<b>MoreTone</b>	Distortion with emphasized midrange body
20	<b>SnrSmack</b>	Emphasizes snappy snare sound
21	<b>Shudder!</b>	Sliced sound for techno tracks
22	<b>SwpPhase</b>	Phaser with powerful resonance
23	<b>DirtyBiz</b>	Lo-fi distortion using ring modulator
24	<b>Doubler</b>	Doubling for vocal track
25	<b>SFXlab</b>	Forces special effect sound on synthesizer
26	<b>SynLead2</b>	Old-style jet sound for synthesizer lead
27	<b>Tekepiko</b>	For sequenced phrases or single note muted guitar
28	<b>Soliner</b>	Simulates analog strings ensemble
29	<b>HevyDrum</b>	For hard rock drums
30	<b>SM57Sim</b>	Simulation of SM57 mic suitable for recording of various analog instruments as well as guitars
31	<b>MD421Sim</b>	Simulation of MD421 professional standard mic indispensable for broadcasting, recording and live applications
32	<b>U87Sim</b>	Simulation of U87, a standard condenser type microphone used in studios worldwide
33	<b>C414Sim</b>	Simulation of C414, a famous microphone highly trusted in recording situations
34	<b>Doubling</b>	Creates doubled sounds as if the entire sound body became thicker
35	<b>ShortDLY</b>	Delay sound suitable for vocals and field recordings, and also for creating a gimmicky effect
36	<b>Lo-Fi</b>	Create Lo-Fi sounds with a nostalgic atmosphere as if the sound is coming from a radio
37	<b>Limiter</b>	A limiter very effective on band rehearsals and live recording
38	<b>BoostPls</b>	Boosts sound by adding sound pressure during recording
39	<b>All Comp</b>	Compressor adjusts volume differences of instruments in a band performance, for example, and evens them out
40-59	<b>Empty</b>	

8x COMP EQ algorithm			
No.	Name	Comment	Recommended input 1 - 8
0	<b>VocBand</b>	For vocal band	1
			2
			3
			4
			5-6
			7-8
1	<b>Inst</b>	For jazz or fusion band	1-2
			3
			4
			5-6
			7-8
			Keyboard
2	<b>AcoBand</b>	For acoustic band	1
			2
			3
			4
			5-6
			7-8

# Effect patch list 5

3	1ManBand	For private recording studio	1-2	Guitar
			3	Bass
			4	Keyboard
			5	Vocal
			6	Chorus
			7-8	Sequencer
4	StdDrum	Standard sound for recording each sound of a drum kit	1	Bass drum
			2	Snare drum
5	VtgDrum	1970s drum sound with enhanced hi-hat	3	Hi-hat
			4	High tom
6	EhcdDrum	Punchy compressed drum sound	5	Mid tom
			6	Low tom
			7-8	Overhead mics
7	Percus	Suitable for recording individual percussion sounds	1-2	Various percussion
			3-4	Cymbal/bell
			5-6	Drums
			7-8	All percussion together
8	CompLtr	Versatile, mellow sound	1-8	
9	A Capla	For a cappella group	1-2	Female vocals
			3-4	Male vocals
			5-6	Vocal duo
			7-8	All vocals together
10-19	Empty			

## MASTERING algorithm

No.	Name	Comment
0	PlusAlfa	Enhances the overall power
1	All-Pops	Conventional mastering
2	StWide	Wide-range mastering
3	DiscoMst	For club sound
4	Boost	For hi-fi finish
5	Power	Powerful low range
6	Live	Adds a live feel
7	WarmMst	Adds a warm feeling
8	TightUp	Adds a hard feeling
9	1930Mst	Mastering with 1930's sound
10	LoFi Mst	Lo-fi mastering
11	BGM	Mastering for background music
12	RockShow	Gives a rock style mix a live feel
13	Exciter	Lo-fi mastering with slight distortion in mid and upper range
14	Clarify	Emphasizes high-end range
15	VocalMax	Brings vocals to the foreground
16	RaveRez	Special sweep effect using sharp filter
17	FullComp	Strong compression over full frequency range
18	ClearPWR	Power tuning with emphasized midrange
19	ClearDMS	Enhances clarity and spaciousness
20	Maximizr	Boosts overall sound pressure level
21-29	Empty	

# Effect patch list 6

## Send/return effect

CHORUS/DELAY		
No.	Name	Comment
0	<b>Vocal</b>	Chorus for adding color to vocals
1	<b>GtChorus</b>	Chorus to enhance weak guitar sound
2	<b>Doubling</b>	Versatile doubling
3	<b>Echo</b>	Showy analog-style delay
4	<b>Delay3/4</b>	Dotted-8th-note delay in sync with rhythm tempo
5	<b>Delay3/2</b>	Dotted-quarter-note delay in sync with rhythm tempo
6	<b>FastCho</b>	Fast-rate chorus
7	<b>DeepCho</b>	Versatile deep chorus
8	<b>ShortDLY</b>	Versatile short delay
9	<b>DeepDBL</b>	Deep doubling
10	<b>SoloLead</b>	Keeps fast phrases tight
11	<b>WarmyDly</b>	Simulates warm analog delay
12	<b>Enhancho</b>	Enhancer using phase shift doubling
13	<b>Detune</b>	For instruments with strong harmonics such as an electronic piano or synthesizer
14	<b>Natural</b>	Chorus with low modulation for backing
15	<b>Whole</b>	Whole-note delay in sync with rhythm tempo
16	<b>Delay2/3</b>	Half-triplet-note delay in sync with rhythm tempo
17	<b>Delay1/4</b>	16th-note delay in sync with rhythm tempo
18-29	<b>Empty</b>	

REVERB		
No.	Name	Comment
0	<b>TightHal</b>	Hall reverb with a hard tonal quality
1	<b>BrgtRoom</b>	Room reverb with a hard tonal quality
2	<b>SoftHall</b>	Hall reverb with a mild tonal quality
3	<b>LargeHal</b>	Simulates the reverberation of a large hall
4	<b>SmallHal</b>	Simulates the reverberation of a small hall
5	<b>LiveHous</b>	Simulates the reverberation of a club
6	<b>TrStudio</b>	Simulates the reverberation of a rehearsal studio
7	<b>DarkRoom</b>	Room reverb with a mild tonal quality
8	<b>VcxRev</b>	Tuned to enhance vocals
9	<b>Tunnel</b>	Simulates the reverberation of a tunnel
10	<b>BigRoom</b>	Simulates the reverberation of a gym
11	<b>PowerSt.</b>	Gate reverb
12	<b>BritHall</b>	Simulates the bright reverb of a concert hall
13	<b>BudoKan</b>	Simulates the reverberation at the Budokan in Tokyo
14	<b>Ballade</b>	For slow ballads
15	<b>SecBrass</b>	Reverb for brass section
16	<b>ShortPla</b>	Short reverb
17	<b>RealPlat</b>	Spring reverb simulation
18	<b>Dome</b>	Reverb of a domed-stadium
19	<b>VinSprin</b>	Simulates analog spring reverb
20	<b>ClearSpr</b>	Clear reverb with short reverb time
21	<b>Dokan</b>	Simulates the reverberation of a clay pipe
22-29	<b>Empty</b>	

# Specifications

Section		R16	
Recorder	Track count	16 (monaural)	
	Maximum number of simultaneous recording tracks	8	
	Maximum number of simultaneous playback tracks	16 audio + metronome	
	Recording data format	44.1kHz, 16/24bit	
	Maximum recording time	200 minutes/1GB (of mono tracks)	
	Projects	1000 maximum per SD Card	
	Markers	100/project	
	Locator	Minute/second/millisecond or bar/beat/tick	
	File editing	Divide	
	Other functions	Punch-in/out (manual, automatic), Bounce, A-B repeat, UNDO/REDO	
Audio interface	Number of input channels	8	
	Number of output channels	2	
	Quantization	24-bit	
	Sampling frequency	44.1, 48, 88.2, 96 kHz	
Mixer	Faders	9 (monaural x 8, master x 1)	
	Level meters	4-segment display	
	Track parameters	3-band equalizer, pan (balance), effect send x 2, invert	
	Stereo linking	Track pairs 1/2 – 15/16 selectable	
Effects	Algorithms	9 (CLEAN, DISTORTION, ACO/BASS SIM, BASS, MIC, DUAL MIC, STEREO, 8x COMP EQ, MASTERING)	
	Patches	330 insert, 60 send return	
	Effect modules	7 insert, 2 send return	
	Tuner	Chromatic, guitar, bass, open A/D/E/G, D modal	
Metronome	Tones	5	
	Beat	No accent, 1/4 - 8/4, 6/8	
	Tempo	40.0~250.0 BPM	
Others	Other functions	Sequential playback, synchronized recording	
Hardware	Recording media	SD card (16MB-2GB), SDHC card (4-32GB)	
	Analog-digital conversion	96kHz 24bit delta-sigma ADC	
	Digital-analog conversion	96kHz 24bit delta-sigma DAC	
	Display	20-digit 2-line custom LCD (with backlight)	
	Inputs	INPUT 1-8	XLR/standard phone combo jack x8 Input impedance: (Balanced input) 1KΩ balanced, 2 hot (Unbalanced input) 50KΩ unbalanced 1 equipped with Hi-Z switch, input impedance 470kΩ (Hi-Z on) 2 equipped with phantom power switches Input level: -50dBm < continuous < +4dBm
		Built-in microphones	Omnidirectional condenser microphones Gain: -50dBm < continuous < +4dBm
	Phantom power supply	48V	
	Output	OUTPUT	TRS phone type (balanced)
		PHONES	Standard stereo phone jack 20mW x 2 (32Ω load)
	USB		USB 2.0 High Speed (operation as audio interface/control surface or card reader)
	Power supply		DC 5V 1A AC adaptor (ZOOM AD-14) Six AA batteries (4.5-hour continuous operation time with backlight on and phantom power off)
	Dimension		376mm (W) × 237.1mm (D) × 52.2mm (H)
Weight		1.3kg	

# Troubleshooting

If you have any problems during operation of the R16, check the following points first.

## Problems during playback •••••

**No sound, or sound is very weak.**

- Check the connections to your monitoring system and the volume settings of the system.
- Make sure that status keys in the mixer section are lit green (except the [MASTER] status key) and that faders are raised. If a key is not green, press it repeatedly until it lights green.
- Make sure that the [MASTER] status key is not lit and that the [MASTER] fader is raised.

**Moving the fader does not affect the volume.**

- On channels for which stereo link is turned on, the fader of the even-numbered channel will have no effect. Either turn stereo link off (→P.20), or use the fader of the odd-numbered channel in the pair.

**No sound from input signal, or sound is very weak.**

- Make sure that the [GAIN] control for the respective input is increased.
- Check that the status light is green (playback enabled) and that the fader of the track is raised.

**An operation does not work and the message “Stop Recorder” is shown on the display.**

- Some operations are not possible while the recorder is operating. Press the [STOP] key to stop the recorder and then conduct the operation.

## Problems during recording •••••

**Cannot record on a track.**

- Make sure that you have selected and enabled a recordable track.
- Check whether you have run out of free space on the SD card (→P.70).
- Recording is not possible if the project is protected. Either set “PROTECT” to “OFF” (→P.54), or use a different project.

**The recorded sound is distorted.**

- Make sure that the [GAIN] (input sensitivity) and recording level are not set too high.
- Lower the fader so that the 0 (dB) indicator of the level meter does not light.

- If the EQ gain of the track mixer is set extremely high, the sound may be audibly distorted even if the fader is lowered. Set the EQ gain to a lower value.
- When an insert effect is applied to an input, check whether the effect output level (patch level) setting is appropriate.

## Problems with effects •••••

**Insert effect cannot be inserted.**

- When using the 8x COMP EQ algorithm, the selection of insert points is limited (→P.49).

**Insert effect does not work.**

- Check that the “INSERT EFFECT” icon is shown on the display. If it is not shown, press the [INSERT EFFECT] key and then press [ENTER] to enable it.
- Make sure that the insert effect is inserted in the desired location (→P.49).

**Send/return effect does not work.**

- Check that the “CHORUS/DELAY” icon is shown on the display. If it is not shown, press the SEND RETURN EFFECT key and then press [ENTER] to enable it.
- Make sure that the send level for the track is raised (→P.37, 48).

## Other problems •••••

**Cannot save a project.**

- The project cannot be saved if the project is protected. Set “PROTECT” to “OFF” (→P.56).

**Cannot create a new project or copy a project.**

- If “Project Full” appears on the display, all the memory available on the card has been used. Delete unneeded projects to free up memory.

**An error message is shown when attempting to execute a command.**

- Please check the error message list (→P.44).

# Index

## A

A-B repeat function →**P.30**

Point A →**P.30**

Point B →**P.30**

Algorithm →**P.45**

Audio interface →**P.75**

Auto punch in/out →**P.27**

## B

Bit rate →**P.67**

Bounce →**P.39**

Built-in microphone →**P.11, 19**

## C

Changing names →**P.43, 61**

Chromatic tuner →**P.33**

Connections →**P.11**

Contrast →**P.68**

Control surface →**P.75**

## D

Date setting →**P.14**

Deletion

Deleting files →**P.62**

Delete letters →**P.43**

Deleting marks →**P.32**

Deleting projects →**P.62**

Display →**P.16**

Backlight →**P.68**

Contrast →**P.68**

## E

Effects

Effect modules →**P.51-52, 79-88**

Effect parameters →**P.52, 79-88**

Effect types →**P.47, 51, 79-88**

Insert effect →**P.41, 45-55**

Mastering effect →**P.41**

Send return effect →**P.45-48, 51-54**

EQ →**P.37-38, 80**

## F

File

Change files names →**P.61**

Copy files →**P.60**

Delete files →**P.62**

File information →**P.59**

Import files →**P.64**

Select files →**P.58**

Formatting an SD card →**P.70**

## G

GAIN →**P.21**

## H

Hi-Z →**P.18**

## I

Import

File import →**P.64**

Patch import →**P.54**

Project import →**P.64**

USB memory import →**P.74**

Using the card reader →**P.73**

Input sensitivity (gain) →**P.21**

Insert effect →**P.41, 45-55**

Before the master fader →**P.41**

Insertion position →**P.49**

Using only for monitoring →**P.55**

## L

Level

Track level →**P.21**

Send level →**P. 37**

Locating →**P.31**

## M

Manual punch-in/out →**P.28**

Marks →**P.31**

Master track →**P.42**

Mastering effect →**P.41**

Metronome →**P.34**

Mixer & Mixing →**P.36**

Mix Down →**P.42**

Stereo link →**P.20**

Track parameters →**P.38**

Track mixer settings →**P.37**

## O

Out point for punch recording →**P.27**

Overdubbing →**P.25**



**P**Pan →**P.37**

Patches

Change patch names →**P.51**Edit patches →**P.51**Format patches →**PDF**Import patches →**P.53**Patch list →**P.89-94**Save and change patches →**P.53**Select patches →**P.51**

Power

Power On/Off →**P.13-14**Installing batteries →**P.13**Battery type setting →**P.71**

Punch-in/out

Automatic punch-in/out →**P.27**Manual punch-in/out →**P.28**Punch-in/out points →**P.27**Playlist →**P.65-66**

Project

Basic operations →**P.56**Creating a new project →**P.17, 57**Changing projects names →**P.61**Copying projects →**P.60**Deleting projects →**P.62**Protecting projects →**P.56**Selecting projects →**P.58**Sequential playback →**P.65****R**

Recording

Overdubbing →**P.25**Preparation before recording →**P.17**Recording the first track →**P.21**Recording second and later times →**P.25**Recording on a master track →**P.42**Recording format →**P.67**Tracks assignment →**P.23****S**

SD card

Card capacity confirmation →**P.70**Card reader →**P.73**Changing card with power on →**P.69**Formatting a card →**P.70**Insertion →**P.12**Selecting and using jacks →**P.11, 18, 19**

Send return effect

Patches →**P.51-54**Track send level setting →**P.37**Sequential project playback →**P.65**Shutdown →**P.13**Specifications →**P.95**Stereo link →**P.20**Stereo settings →**P.19**Switches and keys →**P.15, 18-19**System version →**P.71****T**Tracks →**P.20-26, 29, 35, 37-40**Track assignment →**P.23**Track mixer settings →**P.37**Track parameters →**P.38**Tuner functions →**P.33**Tuner types →**P.33****U**USB →**P.72-76**DAW software operation →**PDF**Exchanging files with a computer →**P.73**Using USB memory →**P.74**

## FCC regulation warning (for U.S.A.)

This equipment has been tested and found to comply with the limits for a Class B digital device, pursuant to Part 15 of the FCC Rules. These limits are designed to provide reasonable protection against harmful interference in a residential installation. This equipment generates, uses, and can radiate radio frequency energy and, if not installed and used in accordance with the instructions, may cause harmful interference to radio communications. However, there is no guarantee that interference will not occur in a particular installation. If this equipment does cause harmful interference to radio or television reception, which can be determined by turning the equipment off and on, the user is encouraged to try to correct the interference by one or more of the following measures:

- Reorient or relocate the receiving antenna.
- Increase the separation between the equipment and receiver.
- Connect the equipment to an outlet on a circuit different from that to which the receiver is connected.
- Consult the dealer or an experienced radio/TV technician for help.

## For EU Countries



### Declaration of Conformity:

This product complies with the requirements of  
EMC Directive 2004/108/EG and  
Low Voltage Directive 2006/95/EC



### Disposal of Old Electrical & Electronic Equipment (Applicable in European countries with separate collection systems)

This symbol on the product or on its packaging indicates that this product shall not be treated as household waste. Instead it shall be handed over to the applicable collection point for the recycling of electrical and electronic equipment. By ensuring this product is disposed of correctly, you will help prevent potential negative consequences for the environment and human health, which could otherwise be caused by inappropriate waste handling of this product. The recycling of materials will help to conserve natural resources. For more detailed information about recycling of this product, please contact your local city office, your household waste disposal service or the shop where you purchased the product.

# ZOOM

ITOHPIA Iwamotocho 2-chome Bldg. 2F

2-11-2 Iwamoto-cho, Chiyoda-ku, Tokyo 101-0032 Japan

Web site: <http://www.zoom.co.jp>

R16-5000-1