

DS-1

Distortion

Owner's Manual



AC & BATTERY
POWERED



 **BOSS**

Thank you, and congratulations on your choice of BOSS DS-1 Distortion.

Before using this unit, carefully read the sections entitled: "USING THE UNIT SAFELY" and "IMPORTANT NOTES" (separate sheet). These sections provide important information concerning the proper operation of the unit. Additionally, in order to feel assured that you have gained a good grasp of every feature provided by your new unit, this manual should be read in its entirety. The manual should be saved and kept on hand as a convenient reference.

Copyright © 1994 BOSS Corporation

All right reserved. No part of this publication may be reproduced in any form without the permission of BOSS Corporation.

FEATURES

The DS-1 is an effect unit that generates both distortion and sustain effects.

By rotating the knobs you can create all kinds of sounds, from warm, soft sustain to hard, powerful distortion.

The DS-1 can be powered by a battery or an optional AC adaptor.

PANEL DESCRIPTIONS

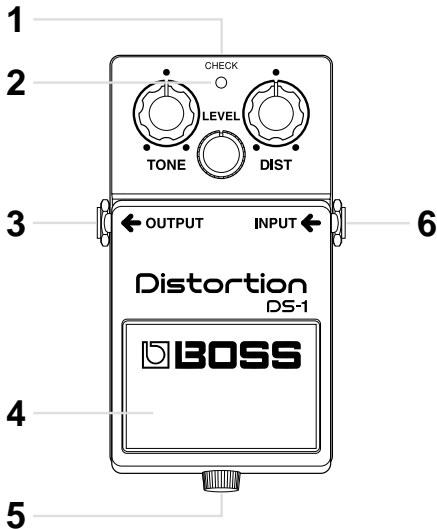

1. AC Adaptor Jack

Accepts connection of an AC Adaptor (optionally available BOSS PSA-Series). By using an AC Adaptor, you can play without being concerned about how much battery power you have left.

** You may find that it is a good idea to keep a battery installed in the unit even while using an adaptor. That way your playing won't be disrupted even if the adaptor is accidentally disconnected.*

** If you are going to use an AC adaptor, be sure to use the specified unit (BOSS PSA-Series). Use of any other adaptor may result in damage, malfunction or electric shock. Also, if you are not going to be using it for an extended period of time, disconnect the AC adaptor from the AC outlet.*

2. CHECK Indicator

This indicator shows whether an effect is ON/OFF, and also doubles as the Battery Check indicator.

The indicator lights when an effect is ON. If this indicator goes dim or no longer lights while an effect is ON, the battery is near exhaustion and should be replaced immediately.

** The CHECK indicator shows whether the effect is being applied or not. It does not indicate whether the power to the device is on or not.*

3. OUTPUT Jack

The output jacks are used to connect the unit to amplifiers or other devices.

4. Pedal Switch

This switch turns the effects ON/OFF.

5. Thumbscrew

This thumbscrew is loosened to open the pedal, allowing battery replacement. For instructions on how to replace the battery, please refer to "Changing the Battery."

6. INPUT Jack

This jack accepts input signals (coming from a guitar, some other electric or electronic musical instrument, or another effects unit).

** The INPUT jack also serves as the power switch. Power is turned on whenever a plug is inserted into the INPUT jack, and is turned off when the plug is disconnected. When not using the unit, you should disconnect any cord connected to the INPUT jack.*

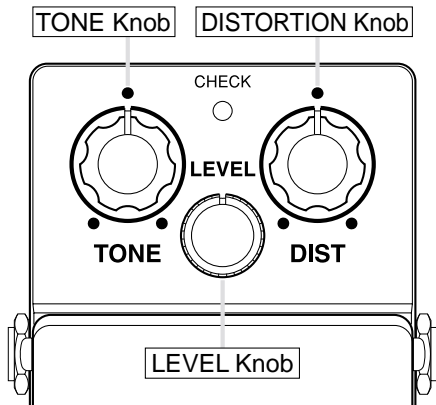

TONE Knob

This knob controls the tone of the distortion sounds. Rotating the knob clockwise cuts lower frequencies, creating sharp sounds. Rotating the knob counterclockwise cuts higher frequencies, creating softer, warmer sounds.

DISTORTION Knob

This knob controls the depth of distortion sounds and the length of sustained sounds. Rotating the knob clockwise creates deeper distortion and a longer sustain time.

LEVEL Knob

This knob adjusts the level of the effect sounds. Set the knob so there is no volume difference between the effect and straight guitar sounds.

MAKING THE CONNECTIONS

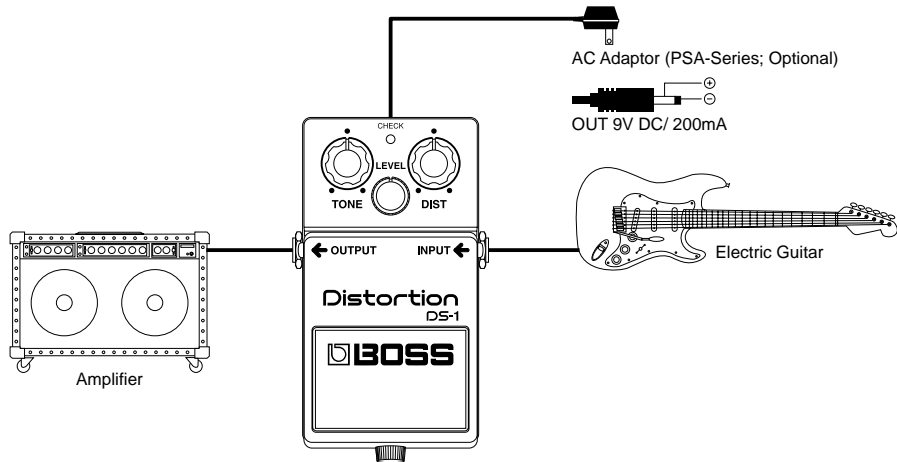

** Inserting a plug into the Input Jack will automatically switch the unit on.*

** Before connecting or disconnecting any patch cords, be sure all the volume controls in your system are set to minimum. This will help prevent any damage to system components.*

OPERATING THE UNIT

1. After you have made the necessary connections, set the knobs as shown in the illustration.
2. Depress the pedal switch to turn the effect on. (Make sure that the CHECK Indicator lights.)
3. Adjust the depth of distortion with the DISTORTION Knob.

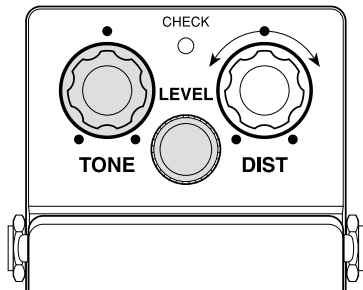
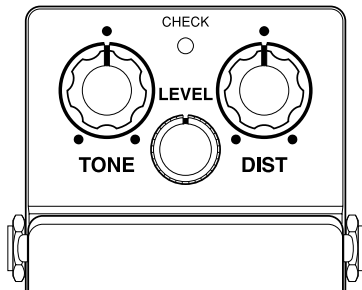

4. Adjust the distortion tone using the TONE Knob.

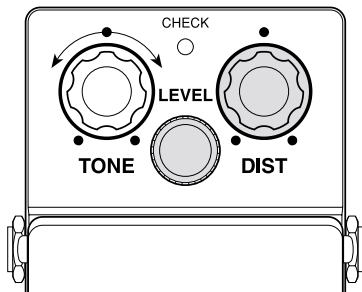

5. Set the LEVEL Knob so there will be no volume difference between the effect sounds and the straight guitar sounds.

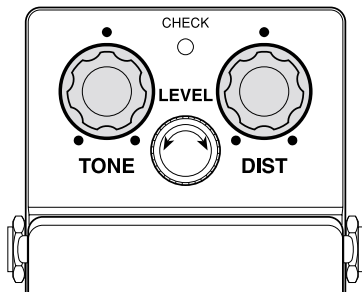

CHANGING THE BATTERY

When the indicator goes dim or no longer lights while an effect is on, it means that the battery is nearly dead and must be replaced.

Replace the battery following the steps below.

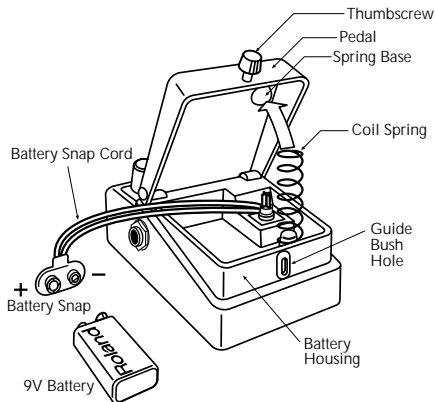

1. Loosen the thumbscrew at the front of the pedal, then lift the pedal upwards to open the unit.

** The thumbscrew can be left in the pedal while changing the battery.*

2. Remove the old battery from the battery housing, and remove the snap cord connected to it.

3. Connect the snap cord to the new battery, and place the battery inside the battery housing.

** Be sure to carefully observe the battery's polarity (+ versus -).*

4. Slip the coil spring onto the spring base on the back of the pedal, then close the pedal.

** Carefully avoid getting the snap cord caught in the coil spring.*

5. Finally, insert the thumbscrew into the guide bush hole and fasten it securely.

SAMPLE SETTINGS

Hard Rock

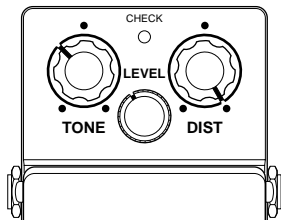

British Punk

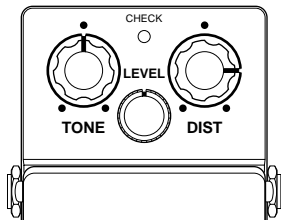

American Rock

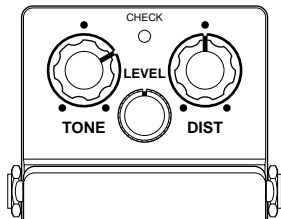

Natural Clip

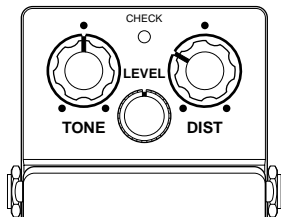

Crunch

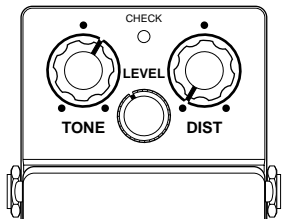

Mild & Warm

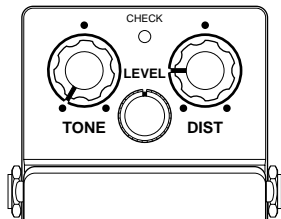

Fuzz

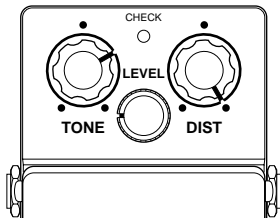

Fusion

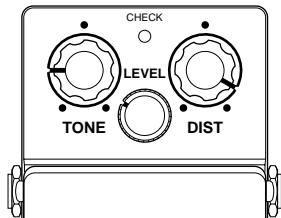

SETTING MEMO

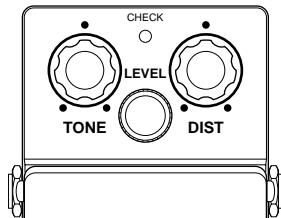
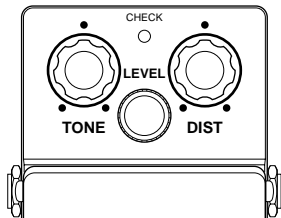
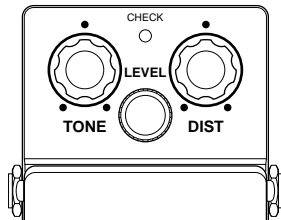
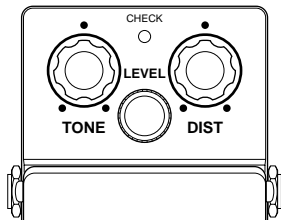

SPECIFICATIONS

DS-1: Distortion

Nominal Input Level -20 dBu

Input Impedance 470 Ω

Nominal Output Level -20 dBu

Output Impedance 1 k Ω

Equivalent Input Noise Level -122 dBu (IHF-A, Typ.)

Controls Pedal Switch, TONE Knob, DISTORTION Knob,
LEVEL Knob

Indicator CHECK Indicator (serves also as battery check indicator)

Connectors INPUT Jack, OUTPUT Jack, AC Adaptor Jack(9 V DC)

Power Supply 9 V DC: Dry Battery 9 V type(6F22/9 V), AC Adaptor

Current Draw 4 mA (9 V DC)

** Expected battery life under continuous use:*

Carbon: 90 hours

These figures will vary depending on the actual conditions of use.

Dimensions	73 (W) x 129 (D) x 59 (H) mm 2-7/8 (W) x 5-1/8 (D) x 2-3/8 (H) inches
Weight	400 g / 15 oz (including battery)
Accessories	Owner's Manual, Dry Battery 9 V type (6F22/9 V), Leaflet ("USING THE UNIT SAFELY," "IMPORTANT NOTES," and "Information")
Options	AC Adaptor PSA-Series

* $0 \text{ dBu} = 0.775 \text{ V rms}$

* *In the interest of product development, the specifications and/or appearance of this unit are subject to change without prior notice.*



For EU Countries
This product complies with the requirements of
European Directive 89/336/EEC.

 **BOSS**

G601720403